

Turned contacts turned crimp male contact for wire gauge 14

Part No. VN 01 036 0005 (1)C



Series Contacts

Subseries Contact Turned contacts

#### COMMON CHARACTERISTICS

Wire gauge from		2,5
Wire gauge (AWG) from		14
Packaging / supplied as		Single contact
No. of pieces		100
Sex of Contact		Pin
Type of contact		Turned crimp contact

#### ELECTRICAL CHARACTERISTICS

Contact resistance	DIN EN 60512-2-1, Test 2a / IEC 60512-2-1, Test 2a	0 m
--------------------	--	-----

Turned contacts turned crimp male contact for wire gauge 14

Part No. VN 01 036 0005 (1)C

Series Contacts

Subseries Contact Turned contacts

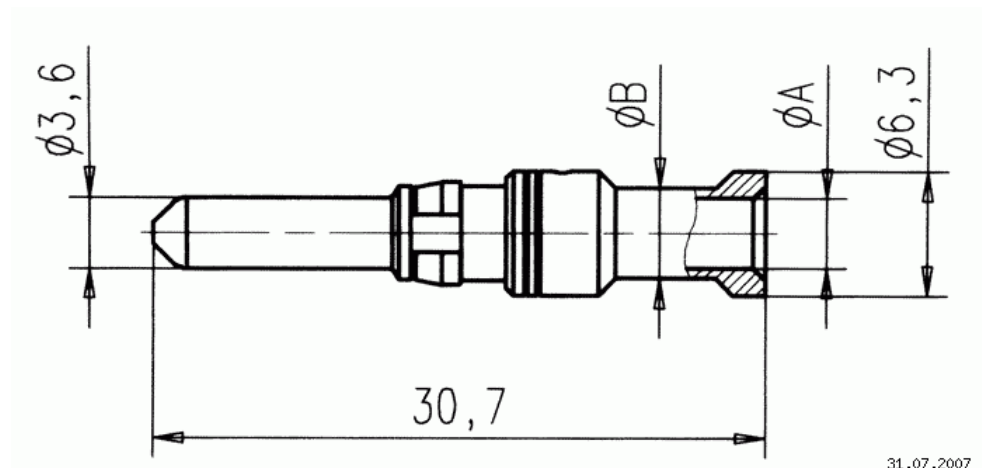

Ma zeichnung Dimensions in mm (Inch)

31.07.2007