









## Ficha técnica

### Rueda BH-PPI 2-2525

| Codigo |  |  |  | Tipo cojinete<br>Eje |  |  |  |  |  |
|--------|-----------------------------------------------------------------------------------|-----------------------------------------------------------------------------------|-----------------------------------------------------------------------------------|----------------------|-----------------------------------------------------------------------------------|------------------------------------------------------------------------------------|-------------------------------------------------------------------------------------|-------------------------------------------------------------------------------------|-------------------------------------------------------------------------------------|
| 2-2525 | 60                                                                                | 50                                                                                | 22                                                                                | —                    | -                                                                                 | -                                                                                  | 10                                                                                  | 85                                                                                  | 62                                                                                  |



#### Características

Fabricada con chapa de acero hasta 2 m/m de espesor.  
Soporte con doble rodamiento a bolas.  
Acabado cincado brillante.  
Fabricadas según normas europeas EN 12528/12530.

#### Datos técnicos

**Diámetro:** 60 mm  
**Carga:** 50 kg  
**Tipo de cojinete:** Cojinete Liso  
**Ancho de Banda de rodadura:** 22 mm  
**Diámetro agujero pasante:** 10 mm  
**Altura total:** 85 mm  
**Radio de giro:** 62 mm

#### Archivos CAD

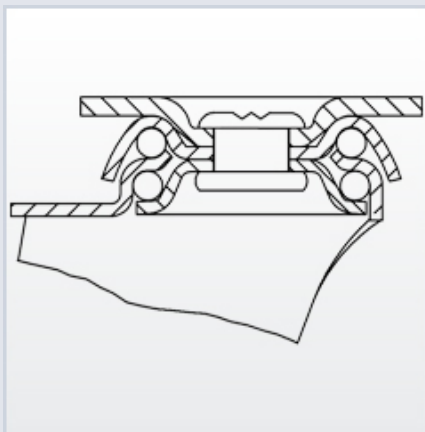

#### Rueda

**PPI (Poliuretano)**  
Núcleo de poliamix y banda de poliuretano( 95° shore A)  
**Rango de temperatura:** -25° ÷ +80°

