



Figure similar

CIRCUIT BREAKER 3VA2 IEC FRAME 100 BREAKING CAPACITY CLASS L ICU=150KA @ 415 V 4POLE, LINE PROTECTION ETU350, LSI, IN=25A OVERLOAD PROTECTION IR=10A ...25A SHORT CIRCUIT PROTECTION ISD=1,5... 10 X IR, II=12 X IN NEUTRAL PROTECTION ADJUSTABLE(OFF,100%) BUSBAR CONNECTION

Model		
product brand name		SENTRON
Product designation		Molded case circuit breaker
Design of the product		Line protection
Product variations		Selective Applications
Ground fault monitoring version		Without
Design of the auxiliary release		without auxiliary release
Design of the auxiliary switch		Without
Design of the operating mechanism		toggle handle
Type of the driving mechanism / motor drive		No
Design of the overcurrent release		ETU350
General technical data		
Number of poles		4
Trip class / of the L-trip / with I²t characteristic / initial value		0.5
Trip class / of the L-trip / with I²t characteristic / Full-scale value		17
Electrical endurance (switching cycles)		
• at AC-1 / at 380/415 V / at 50/60 Hz		12 000
circuit-breaker / Design		3VA
Mechanical service life (switching cycles) / typical		20 000
Voltage		
Insulation voltage / Rated value	V	800
Protection class		

Protection class IP		IP40
Protection class IP / on the front		IP40
Protective function of the overcurrent release		LSI

Switching capacity

Switching capacity class of the circuit breaker		L
--	--	---

Dissipation

Active power loss		
<ul style="list-style-type: none"> • maximum 	W	0.5

Electricity

Continuous current / Rated value / maximum	A	100
Continuous current / Rated value	A	25
Adjustable response value current / of the instantaneous short-circuit release / initial value	A	12

Main circuit

Operating voltage		
<ul style="list-style-type: none"> • with AC / at 50/60 Hz / Rated value 	V	690
Operating current		
<ul style="list-style-type: none"> • at 40 °C / Rated value • at 50 °C / Rated value • at 60 °C / Rated value • at 65 °C / Rated value • at 70 °C / Rated value 	A	25
	A	25
	A	25
	A	25
	A	25

Auxiliary circuit

Number of NC contacts / for auxiliary contacts		0
Number of NO contacts / for auxiliary contacts		0

Suitability

Suitability for use		system protection
----------------------------	--	-------------------

Adjustable parameters

Adjustable response value current		
<ul style="list-style-type: none"> • of I-trip / Full-scale value • of the short-time delayed short-circuit release / initial value • of the short-time delayed short-circuit release / Full-scale value 	A	12
	A	1.5
	A	10
Adjustable delay time		
<ul style="list-style-type: none"> • of S-trip / with I2t characteristic / initial value • of S-trip / with I2t characteristic / Full-scale value 	s	0.02
	s	0.4
Adjustable response value current / of the current-dependent overload release / initial value	A	0.4

Product details

Product component		
• Trip indicator		No
• display		No
• undervoltage release		No
Product property		
• for neutral conductors / upgradeable/retrofitable / Short-circuit and overload proof		No
Product expansion / optional / motor drive		Yes

Product function

Product function		
• Intrinsic device protection		Yes
• communication function		No
• Phase failure detection		No
• other measurement function		No

Accessories

Manufacturer article number / of the supplied basic switch		3VA2025-8HN42-0AA0
---	--	------------------------------------

Short circuit

Operational short-circuit current breaking capacity (Ics)		
• at 240 V / Rated value	kA	200
• at 415 V / Rated value	kA	150
• at 440 V / Rated value	kA	150
• at 500 V / Rated value	kA	100
• at 690 V / Rated value	kA	18
Maximum short-circuit current breaking capacity (Icu)		
• at 240 V / Rated value	kA	200
• at 415 V / Rated value	kA	150
• at 440 V / Rated value	kA	150
• at 500 V / Rated value	kA	100
• at 690 V / Rated value	kA	24
Short-circuit current making capacity (Icm)		
• at 240 V / Rated value	kA	440
• at 415 V / Rated value	kA	330
• at 440 V / Rated value	kA	330
• at 500 V / Rated value	kA	220
• at 690 V / Rated value	kA	48





Connections

Arrangement of electrical connectors / for main current circuit		Front terminal
Type of connectable conductor cross-section		13 x 1 mm
<ul style="list-style-type: none"> • for flat-bar terminal connection / minimum • for flat-bar terminal connection / maximum 		25 x 8.5
Type of electrical connection / for main current circuit		Lug terminal

Mechanical Design		
Height	mm	181
Width	mm	140
Depth	mm	107
Mounting type		fixed mounting

Environmental conditions		
Ambient temperature		
<ul style="list-style-type: none"> • during operation / minimum 	°C	-25
<ul style="list-style-type: none"> • during operation / maximum 	°C	70
<ul style="list-style-type: none"> • during storage / minimum 	°C	-40
<ul style="list-style-type: none"> • during storage / maximum 	°C	80

Certificates		
Equipment marking		
<ul style="list-style-type: none"> • acc. to DIN EN 61346-2 		Q
<ul style="list-style-type: none"> • acc. to DIN EN 81346-2 		Q

General Product Approval	EMC	Declaration of Conformity	Shipping Approval
 CCC  VDE  EAC	other	 CE EG-Konf.	 DNV

Shipping Approval	other other  GL
-------------------	--

Further information
Information- and Downloadcenter (Catalogs, Brochures,...) http://www.siemens.com/lowvoltage/catalogs
Industry Mall (Online ordering system) https://eb.automation.siemens.com/mall/en/WW/Catalog/Product/3VA20258HN420AA0
Service&Support (Manuals, Certificates, Characteristics, FAQs,...) http://support.automation.siemens.com/WW/view/en/3VA20258HN420AA0/all

Image database (product images, 2D dimension drawings, 3D models, device circuit diagrams, ...)

http://www.automation.siemens.com/bilddb/cax_en.aspx?mlfb=3VA20258HN420AA0

CAx-Online-Generator

<http://www.siemens.com/cax>

Tender specifications

<http://ausschreibungstexte.siemens.com/tiplv>

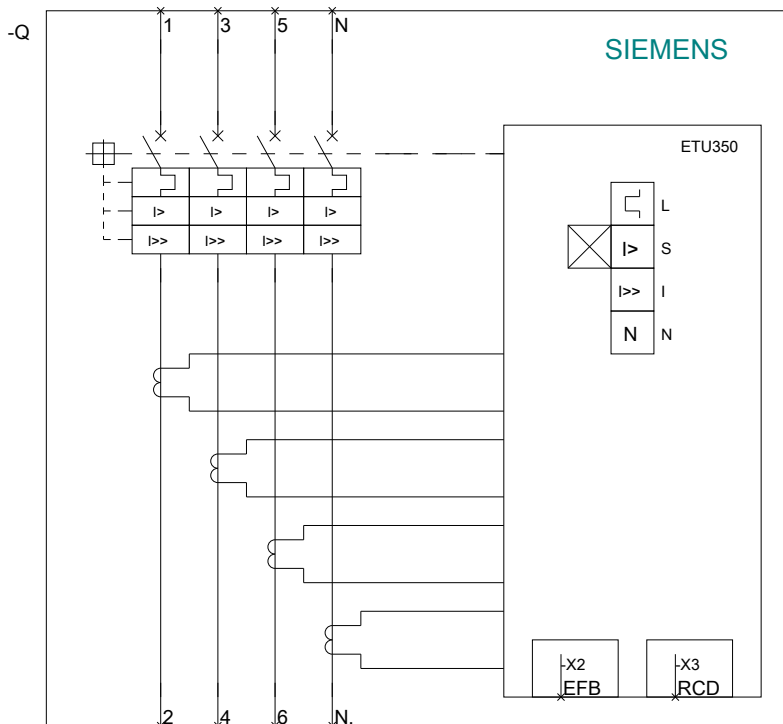
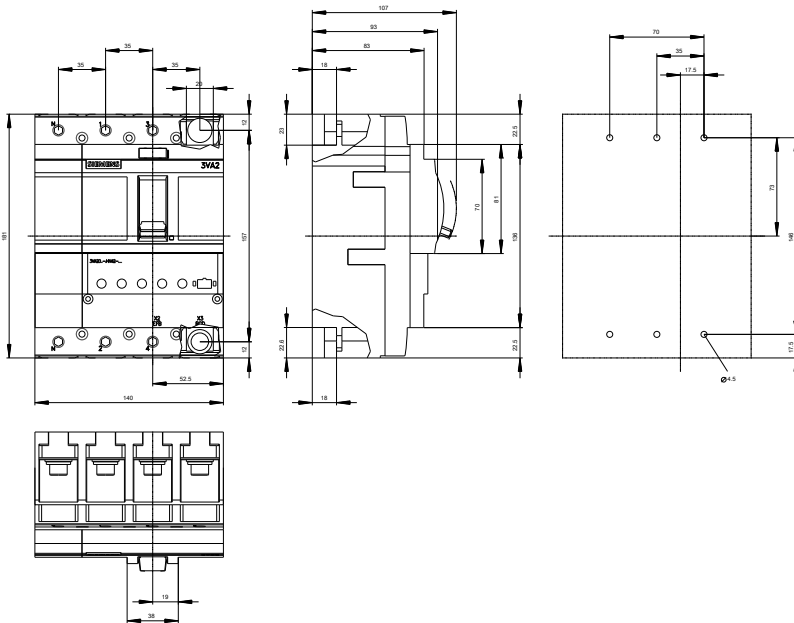

last modified:

11.03.2015