



**HIRSCHMANN**

A Belden Company

# Manual

## PROFIBUS Repeater OZD Profi 12M ...

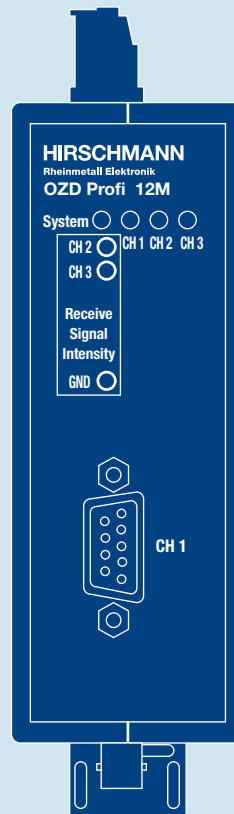
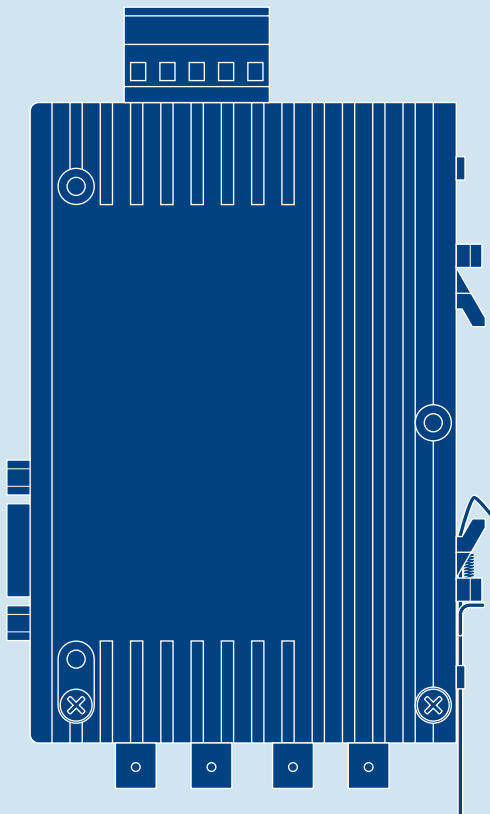

## Order Numbers

OZD Profi 12M P11	943 728-221
OZD Profi 12M P12	943 728-321
OZD Profi 12M G11	943 727-221
OZD Profi 12M G12	943 727-321
OZD Profi 12M G12-EEC	943 730-321
OZD Profi 12M G11-1300	943 729-221
OZD Profi 12M G12-1300	943 729-321
OZD Profi 12M G12-1300 EEC	943 256-321
Description and Operating Instructions PROFIBUS-Repeater OZD Profi 12M ...	039 629-001

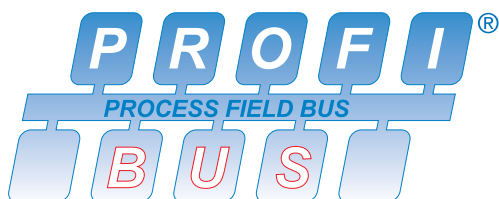

Description and Operating Instructions are protected by copyright.  
All rights reserved.

The reproduction, duplication, translation, conversion to any electronic medium or machine-readable form in whole or in part is not permitted

The following Description and Operating Instructions have been produced by Hirschmann Automation and Control GmbH to the best of the company's knowledge.

Hirschmann reserves the right to amend the contents of this Description and Operating Instructions without prior notice.

Hirschmann cannot provide any warranty or guarantee with regard to the correctness or accuracy of the information contained in this Description and Operating Instructions.

Under no circumstances can Hirschmann be held liable for any damage arising from the use of the PROFIBUS-Repeater OZD Profi 12M ... .

© 2007 Hirschmann Automation and Control GmbH

The naming of registered trademarks in the following Description and Operating Instructions, even if not specifically identified as such, should not warrant the assumption that such names are not subject to the terms stipulated in the trademark and trademark protection legislation and that they can therefore be freely used by anyone.

# Contents

<b>1 Introduction</b>	5
<b>2 General Functions</b>	7
2.1 Non operating mode related functions	7
2.2 Operating mode related functions	7
<b>3 Network Topologies</b>	9
3.1 Line topology	9
3.1.1 Line topology with optical fiber link monitoring and segmentation	10
3.1.2 Line topology without optical fiber link monitoring	11
3.2 Star topology	12
3.3 Redundant optical ring	13
<b>4 Setting Up</b>	15
4.1 Safety notice	15
4.2 Notes on CE marking	16
4.3 General information about setting up	16
4.4 Setting compatibility, operating mode and transmitting power	17
4.4.1 Setting the compatibility	17
4.4.2 Setting the operating mode	18
4.4.3 Reducing the optical transmitting power on the OZD Profi 12M P11 and OZD Profi 12M P12	19
4.5 Installation	20
4.5.1 Installation guidelines	20
4.5.2 Connecting the optical lines	22
4.5.3 Mounting the modules	22
4.5.4 Connecting the electric RS 485 bus lines	24
4.5.5 Connecting the power supply	25
4.5.6 Connecting the signaling contact lines	25
4.5.7 Defining the receiving level of the optical ports	26
<b>5 LED Indicators and Troubleshooting</b>	27
5.1 LED Indicators	27
5.2 Troubleshooting	29
<b>6 Configuration</b>	31
6.1 Configuration of redundant optical rings	31
<b>7 Technical Data</b>	33

<b>8 Appendix</b> .....	33
8.1 FCC conformity .....	35
8.2 FM approval .....	35
8.3 Ex approval .....	35
8.4 UL/CSA-Zulassung .....	35
8.5 C-Tick .....	36
8.6 Literature notes .....	36
8.7 List of abbreviations .....	36
8.8 Measuring sockets .....	37
<b>9 Application Support</b> .....	38

# 1 Introduction

The PROFIBUS Repeaters OZD Profi 12M ...

- **OZD Profi 12M P11,**
- **OZD Profi 12M P12,**
- **OZD Profi 12M G11,**
- **OZD Profi 12M G12,**
- **OZD Profi 12M G12 EEC,**
- **OZD Profi 12M G11-1300,**
- **OZD Profi 12M G12-1300 and**  
**OZD Profi 12M G12-1300 EEC**

are designed to be used in optical PROFIBUS field bus networks. They enable electrical PROFIBUS interfaces (RS 485 level) to be converted into optical PROFIBUS interfaces and vice-versa.

Table 1, p. 6 shows the different methods for connecting the modules, and the maximum optical ranges of each port.

By profiting from the familiar advantages of optical transmission technology, the modules can be integrated into existing PROFIBUS field bus networks.

A complete PROFIBUS field bus network with modules in line, star or ring topology, and an arbitrary combination of these, can also be built up.

The redundant ring is also supported, thereby increasing the fail-safety of the field bus network.

Each module has two or three mutually independent ports, which in turn consist of a transmitting and a receiving component.

The device is powered by 24V DC voltage. A redundant feed increases operational safety.

The electric port is a 9-pole Sub-D socket (female). An RS 485 bus segment in line with the PROFIBUS standard EN 50170 can be connected to this port.

The optical fibers are connected using BFOC /2.5 (ST®) connectors.

Four multicolored light-emitting diodes indicate the current operating status and possible operating malfunctions.

One measuring output is available for each optical port where the optical input level can be measured using a conventional voltmeter.

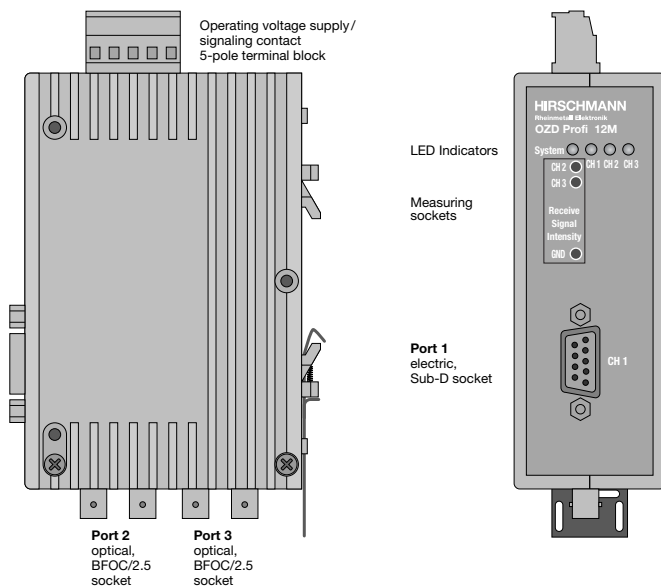

Fig.1: OZD Profi 12M ... module showing the location of the LED indicators, measuring sockets and the individual ports.

Different OZD Profi 12M ... malfunction reports are provided as an accumulative signal via a signaling contact (relay with unconnected contacts) for further processing.

The mechanical design consists of a compact, stable metal housing which can be mounted on a hat rail or mounting plate as required.

The module is configured using easily accessible switches.

The OZD Profi 12M ... complies with the standard EN 50170 and the technical guidelines issued by the PROFIBUS user organization, PNO, "PROFIBUS optical transmission technology".

OZD Profi 12M G12 and OZD Profi 12M G12-EEC have the same function. They only differ in the specification of the climatic ambient conditions: while the OZD Profi 12M G12 is suitable for employment in the standard temperature range from 0°C to 60°C, the OZD Profi 12M G12-EECC (extended environmental conditions) can be used in the extended temperature range from –20°C to +60°C and at up to 100% humidity.

OZD Profi 12M	P11	P 12	G11	G12 G12-EEC	G11-1300	G12-1300 G12-1300 EEC
Number of ports						
– electrical	1	1	1	1	1	1
– optical	1	2	1	2	1	2
Fiber types						
– Plastic optical fibers						
980/1000 µm	80 m	80 m	–	–	–	–
– PCF optical fibers						
200/230 µm	400 m	400 m	–	–	–	–
– Quartz glass optical fibers						
10/125 µm	–	–	–	–	15 km	15 km
50/125 µm	–	–	3000 m	3000 m	10 km	10 km
62.5/125 µm	–	–	3000 m	3000 m	10 km	10 km

Table 1: Number of electrical and optical ports per module, fiber types which can be used, as well as the maximum possible optical fiber distances between two modules. See Technical Data, p. 33 for more details about ambient conditions. PCF stands for Polymer Cladded Fiber, and is the same as HCS®. HCS is a registered trademark of Ensign-Bickford Optics Company.

## 2 General Functions

### 2.1 Non operating mode related functions

#### Transmission rate

The OZD Profi 12M ... support all the transmission speeds (transmission rates) defined in the EN 50170 standard:

9.6 kBit/s, 19.2 kBit/s, 45.45 kBit/s, 93.75 kBit/s, 187.5 kBit/s and 500 kBit/s, and additionally 1.5 MBit/s, 3 MBit/s, 6 MBit/s and 12 MBit/s.

The transmission rate is set automatically as soon as the OZD Profi 12M ... receives a frame. The setting or adjustment is dependent on the transmission rate and the set operating mode. Depending on the OZD Profi 12M ... , this can last up to several seconds.

If the transmission speed has not been recognized, the outputs of all ports are blocked. If the transmission rate changes during operation, this is detected by the modules, which then automatically adjust their settings accordingly.

Transfer malfunctions may temporarily occur while the rate is being altered.

#### Signal regeneration

The modules regenerate the signal form and amplitude of the data received. This allows up to 122 OZD Profi 12M ... to be cascaded (limited by the address space in PROFIBUS networks).

#### Help when setting up

At least one bus subscriber must be switched on and active in order to check the optical fiber connections during the installation. This bus subscriber serves as the frame source. The OZD Profi 12M ... act passively when it is switched on. They recognize the transfer speed from the frames sent by the bus subscriber. An optical help when putting the device into operation is provided by the port LED which then lights up.

### 2.2 Operating mode related functions

The operating mode is set using switches located on the top of the module. A sticker attached to the side of the module provides assistance with the settings.

#### Segment monitoring at the RS 485 port

If the operating mode "Electric port with segment monitoring" is set, each receiver monitors the RS 485 bus segment connected to it for faulty frames or continuously busy networks. If faulty frames are received by the receiver, or if the network is busy for longer than the maximum permitted send time, forwarding of the received signals is blocked until frames can be received again correctly, or if no signal is received for one second.

The RS 485 bus segment is not monitored in the operating mode "Electric port without segment monitoring". Interference from the electrical segment affects the entire network.

Please observe the installation notes in 4.5.4. "Connecting the electric RS 485 bus lines", p. 24.

The following functions are only available for the optical ports. Whether the functions can be activated depends on the operating mode which has been set. Please refer to the following chapters for details.

### Line monitoring with echoes

The modules enable the connected optical paths to be actively monitored for interruptions in the fiber line by means of the functions "Send echo", "Monitor echo" and "Suppress echo".

#### Send echo

A frame which is received by a module via any port is transmitted to all other ports. If the receiving port is an optical port, the module sends the frame back to the corresponding optical sender.

#### Monitor echo

If a module sends a frame - no echo! – to an optical port, the module expects to receive an echo. If the echo is not received after a predefined time, an echo monitoring error is indicated by a red LED belonging to the port.

#### Suppress echo

The relevant receiver is separated from the other ports from the moment a frame is sent until the echo has been received correctly.

### Segmentation

If an echo monitoring error or a frame falsification arises at an optical port, the module assumes that the line is faulty and blocks this port for user data. The connected field bus partial network is then segmented (cut off). This segmentation causes the module at the other end of the optical fiber to be segmented as well.

Both modules connected to the segmented field bus partial network send test frames to the segmented ports. These test frames – which are to be received regularly – can be used by both modules to check the status of the field bus partial network.

The segmentation is automatically lifted as soon as the test frames indicate to both modules that the segmented field bus partial network is no longer disturbed.

If all active bus subscribers are deactivated in a previously active network, the modules are segmented cyclically in order to check the fiber links to the neighboring modules. If there is no frame traffic, but the fiber links are intact, the port LEDs of the optical ports flash yellow cyclically.



## 3 Network Topologies

The following network topologies can be realized with the OZD Profi 12M ... :

- Point-to-point connections
- Line topologies
- Star topologies
- Redundant optical rings

Combinations of these basic types are also possible. Lines with two optical fibers are used to create the fiber links for these network topologies.

If a malfunction – e.g. a break in a fiber line – makes a high degree of field bus network fail-safety necessary, the availability of the network can be increased using a redundant network configuration.

### Please note:

- Single terminals or entire PROFIBUS segments with max. 31 subscribers can be connected to the electrical interface of the OZD Profi 12M ... .
- In areas with a high EMC incidence, only lay optical fiber lines in order to exclude the possibility of EMC affecting the whole network.
- Optically **only OZD Profi 12M ... of the same type** can be connected together:
  - OZD Profi 12M **P11** with ... **P12**
  - OZD Profi 12M **G11** with ... **G12** and ... **G12 EEC**
  - OZD Profi 12M **G11-1300** with ... **G12-1300** and ... **G12-1300 EEC**
- Optical ports which are connected by optical fiber must be set to the same operating mode.
- Junctions between different OZD Profi 12M ... types are only possible via the RS485 interface.
- OZD Profi 12M G12(-1300) EEC can be used everywhere in those network topologies described below in which a OZD Profi 12M G12(-1300) can also be used.

### 3.1 Line topology

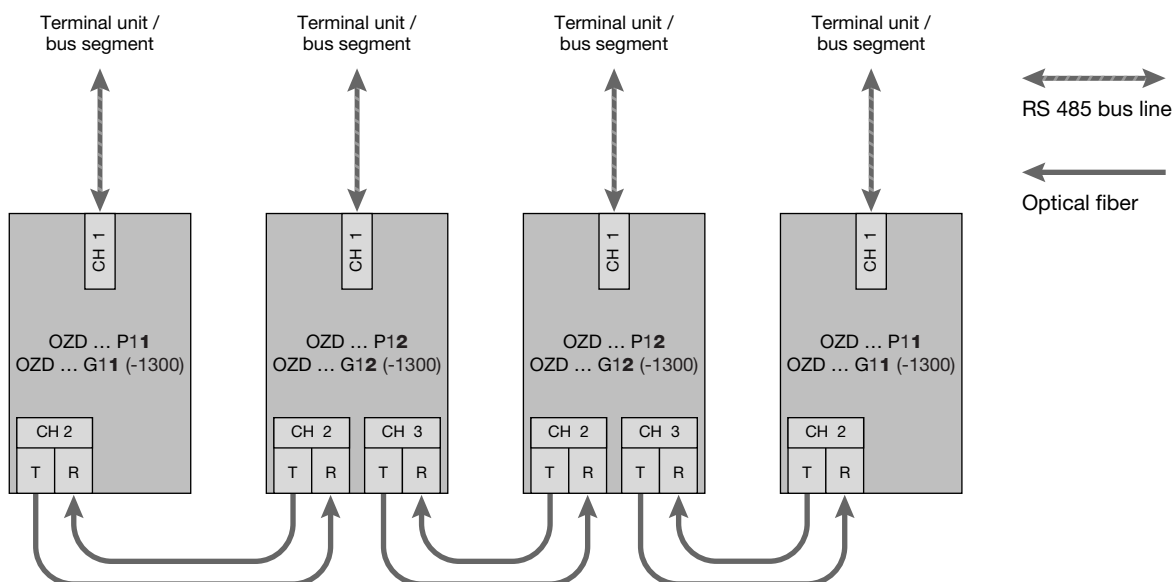

Fig. 2: Network structure in an optical line topology

In a line structure, the individual OZD Profi 12M ... are connected together by dual-fiber optical fibers. Modules with one optical port are sufficient at the beginning and end of a line, between which modules with two optical ports are necessary.

If single point-to-point connections are to be built up, this can be achieved using two modules each with one optical port.

The line topology can be realized with and without fiber link monitoring. If both operating modes are used within an optical fiber line, the operating mode "Line topology without fiber link monitoring" determines the availability of this fiber line. It is recommended that fiber link monitoring be used in homogeneous OZD Profi networks (default factory setting).

### 3.1.1 Line topology with optical fiber link monitoring and segmentation

This operating mode should preferably be used if an interrupted fiber segment is to be separated from the rest of the network.

#### ■ Monitoring mechanisms:

Send echo:	yes
Monitor echo:	yes
Suppress echo:	yes
Monitor:	yes
Segmentation:	yes

In this operating mode the individual fiber links are monitored by the two connected modules.

If a module fails, an optical fiber breaks or faults are determined on the optical transfer link, the fiber link between the two OZD Profi 12M ... is interrupted (segmented).

The PROFIBUS network is divided into two partial networks, which remain functional independently of one other.

Please note that the following ambient conditions must be fulfilled to ensure that network configuration functions correctly:

- The parameters  $\text{MIN } T_{\text{SDR}}$  described in the PROFIBUS standard EN 50170 must be set to a value  $\geq 11$  on all terminals. This is usually the case, but the setting should be checked if communication malfunctions continuously arise.
- When configuring your network, select low bus subscriber addresses wherever possible. This ensures that master timeout times which may arise are kept as short as possible in the event of a malfunction.

Refer to the manufacturer's manual of the terminal concerned for details about how to alter the settings.

The malfunction is indicated at the two OZD Profi 12M ... is connected to the malfunctioning fiber link by the port LEDs switching to red and by activation of the signaling contacts. The segmentation is lifted automatically as soon as both modules recognize that the field bus network is functioning correctly with the help of test frames.

Please note that in the case of networks with several active bus subscribers, two logical token rings are formed in the event of an error. Every time the partial networks are switched together, network malfunctions may arise due to the double tokens or frame collisions.

#### **Note:**

If a module with two optical ports is used at the beginning or end of a line, the optical port which is not assigned must be switched to the operating mode "Line without fiber link monitoring", so that it does not signal a break in the fiber line.

Please note that optical ports which are not connected must always be fitted with protective caps to guard against extraneous light and dirt.

### 3.1.2 Line topology without optical fiber link monitoring

Use this operating mode if you connect a OZD Profi 12M ... with another optical fiber network component, which does not send a frame echo and does not expect or is not compatible with a frame echo in accordance with PROFIBUS guidelines (optical/electrical converter).

■ **Monitoring mechanisms:**

Send echo:	no
Monitor echo:	no
Suppress echo:	no
Monitor:	no
Segmentation:	no

Individual fiber links are not monitored in this operating mode.

### 3.2 Star topology

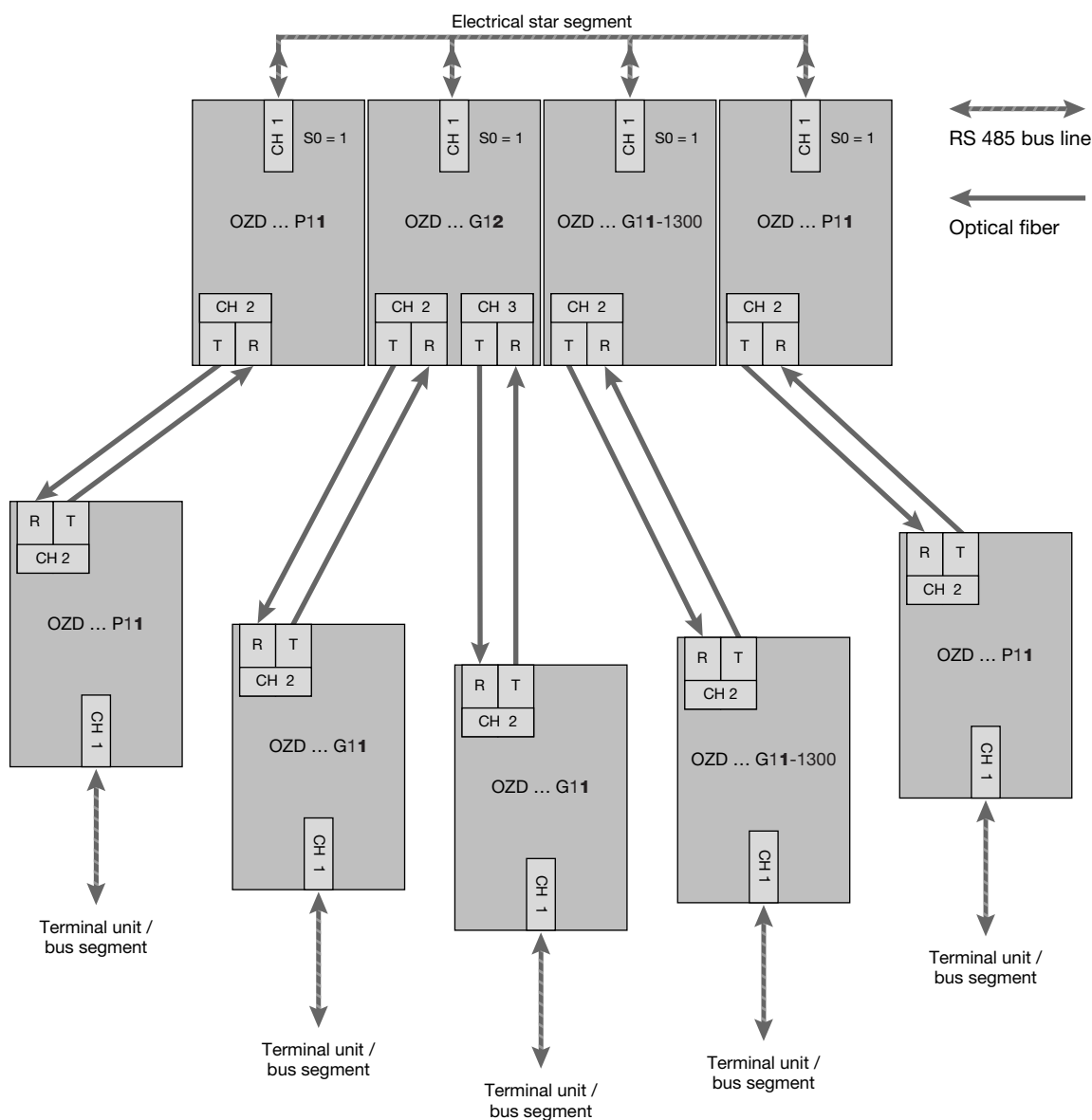

Fig. 3: Network structure in an optic star topology

Several modules are combined to form an active PROFI-BUS star coupler. Other modules are connected to this by dual-fiber optical fiber lines. The modules of the star coupler are connected to one another via the electrical port (electrical star segment). All OZD Profi types for different fiber types (plastic, PCF, glass) can be combined using the electrical star segment.

**Please note:**

- CH1 in mode "Monitor off" (S0 = 1) must be activated on all OZD Profi 12M ... which are connected to the electrical star segment. This deactivates the segmenting function of the RS 485 port on these OZD Profi 12M ..., providing a high degree of availability of the electrical star segment.

- Ensure that the electrical star segment is wired carefully. Keep it as small as possible to avoid interference injection into the electrical star segment, and from here into the entire network. This can be achieved by laying out the OZD Profi 12M ... in the electrical star segment directly next to each other on a hat rail.
- Switch on the terminating resistors in the bus port connectors (see 4.5.4, "Connecting the electric RS 485 bus lines", p. 24) at both ends of the electrical star segment.
- Do not connect a bus subscriber to the electrical star segment wherever possible.

Modules with one or two optical ports can be used to create an active PROFIBUS star coupler. Modules with one optical port are sufficient for connecting a terminal or an RS 485 bus segment to the active star coupler.

If the link monitoring on the optical ports is activated, the fiber optic links are monitored by the respectively connected OZD Profi 12M ....

**Note:**

Optical ports which are not assigned (for instance, because they are reserved for a future system extension) indicate a fiber break if the link monitoring is activated. You can prevent this error report from being issued by activating the operating mode "Line without fiber link monitoring" at the non-assigned ports.

Please note that optical ports which are not connected must always be fitted with protective caps to guard against extraneous light and dirt.

### 3.3 Redundant optical ring

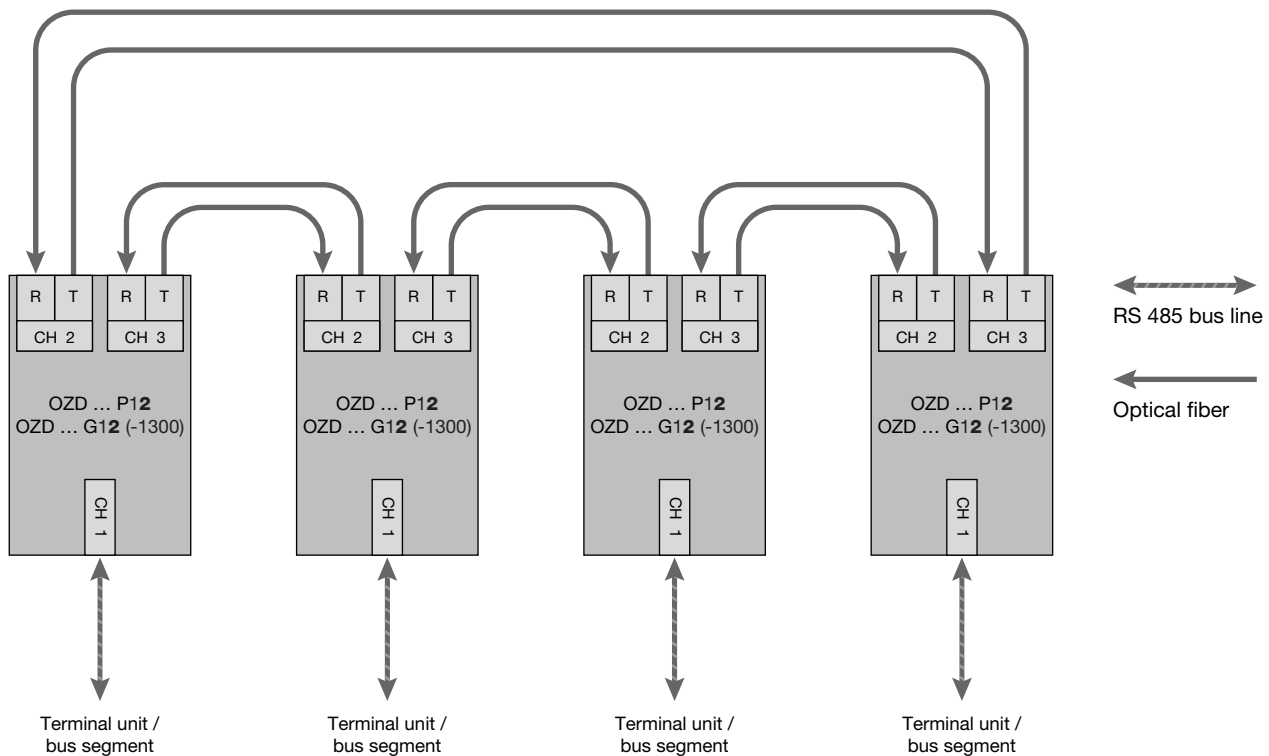

Fig. 4: Network structure in a redundant optical ring topology

This network topology represents a special form of line topology. A high degree of network operating safety is achieved by "closing" the optical line. A redundant optical ring can only be realized with modules with two optical ports of the same type.

■ **Monitoring mechanisms:**

Send echo:	yes
Monitor echo:	yes
Suppress echo:	yes
Segmentation:	yes

An interruption of one or both optical fibers between two modules is detected by the OZD Profi 12M ... and the ring is transformed into an optical line.

If one module fails only those terminals connected to this module or the RS 485 segment are uncoupled from the ring. The remainder of the network itself continues to function as a line. The error is indicated by the LEDs on the two OZD Profi 12M ... connected to the malfunctioning optical fiber and their signaling contacts.

The segmentation is lifted automatically as soon as both modules recognize that the segmented field bus network is functioning correctly with the help of test frames. The line forms itself into a ring.

**Please note:**

The following ambient conditions must be fulfilled to ensure that the network configuration functions correctly:

- The operating mode "Redundant optical ring" must be set at both optical ports of all the OZD Profi 12M ....
- All modules in a ring must be connected to one another by fiber lines. The ring may not include an RS 485 bus line.
- The parameter  $\text{MIN } T_{\text{SDR}}$  described in the PROFIBUS standard EN 50170 must be set to a value  $\geq 11$  on all terminals. This is usually the case, but the setting should be checked if communication malfunctions continuously arise.
- When configuring your network, select low bus subscriber addresses wherever possible. This ensures that master timeout times which may arise are kept as short as possible in the event of a malfunction.

- If a redundancy case occurs (e.g. a line break), there is a switching time during which data cannot be correctly transmitted. In order to ensure a smooth transition, it is recommended that the frame repeat setting (Retry) on the PROFIBUS master be set to at least 3.

After the error has been corrected, no frames should be present in the network when the optical line is transformed back into an optical ring to ensure that the process is completed smoothly.

This condition can arise when a master selects a device whose address has been configured, but which does not physically exist.

The master tries to address this device cyclically and waits for a reply only until the configured slot time has been exceeded ("GAP request"). The OZD Profi 12M ... recognizes this condition and closes the optical line to an optical ring in the middle of this request sequence.

This results in two configuration requirements for the redundant optical ring:

- The value of the parameter **HSA** (Highest Station Address) must be set at all terminals so that between the bus address 0 and the value HSA at least one address in the network has **not** been assigned to a bus subscriber, i.e. so that there is at least one address gap. This address gap can also be created by simply setting the value of the parameter HSA so that it is at least one greater than the highest number of subscriber bus addresses present in the network.

**Attention:** If this requirement is not or no longer fulfilled, the optical line will no longer be closed into a redundant optical ring after segmentation. The error report (LED and signaling contact) of the two affected OZD Profi 12M ... is not cancelled even after the error has been corrected.

- The **slot time** must be set to approximately twice the value required in a non-redundant network. Further information can be found in Chapter 6 "Configuration", p. 31.

Refer to the manufacturer's documentation provided with the terminal or configuration software for details about how to adjust the settings.

## 4 Setting Up

### 4.1 Safety notice

- ⚠ Only use the OZD Profi 12M ... as described in this "Description and Operating Instructions". Pay particular attention to all the warnings and safety instructions.
- ⚠ Only operate the modules with a safety extra-low voltage in accordance with IEC 950/EN 60 950/ VDE 0805 with a maximum rating of +32 VDC (typically +24 VDC).  
The power source must comply with NEC, Class 2, regulations as stipulated by UL/CSA.
- ⚠ Pay attention to the electrical limit values when connecting the power supply to the signaling contacts:  
max. voltage 60 VDC, 42 VAC.  
The connected power supply must also be safety extra-low voltage in accordance with IEC 950/ EN 60 950/ VDE 0805 and comply with NEC, Class 2, regulations as stipulated by UL/CSA.
- ⚠ **DANGER:** Never connect the OZD Profi 12M ... to the main power supply.
- ⚠ Only install the device in a location where the climatic and mechanical limit values given in the Technical Data can be complied with.
- ⚠ **WARNING:** Do not look directly into the aperture of the optical transmitting diode or the optical fiber. The light beam which is emitted could endanger your eyesight.
- ⚠ **WARNING:** All OZD Profi 12M ... are approved for use in Zone 2 explosive hazardous areas as defined by EEx nC [L] IIC T5. If used in those areas, the modules must be installed in a housing (switch cabinet) with protection class IP 54 as per IEC 529.

**OZD Profi 12M P11**  
**OZD Profi 12M P12**  
**OZD Profi 12M G11-1300**  
**OZD Profi 12M G12-1300**  
**OZD Profi 12M G12-1300 EEC**

The optical radiated power of the components used in this device does not represent a potential health hazard of any description under normal, foreseeable conditions, and it complies with Class 1 in accordance with IEC 60825-1:1994+A1:1997 resp. the Degree of Endangerment 1 in accordance with IEC 60825-2:1993.

**OZD Profi 12M G11**  
**OZD Profi 12M G12**  
**OZD Profi 12M G12-EEC**

Non-visible LED radiation.  
 Do not look into the beam, not even with optical instruments. LED class 1M.  
 Classification according  
 IEC 60825-1:1993+A1:1997+A2:2000.

## 4.2 Notes on CE marking

**CE** The PROFIBUS-Repeater OZD Profi 12M ... complies with the specifications of the following "European Directive" as well as with the harmonized European Standards (EN) quoted therein:

89/336/EEC Council Directive on the Approximation of the Laws of Member States relating to Electro-magnetic Compatibility (amended by Directives 91/263/EEC; 92/31/EEC und 93/68/EEC)

Compliance with the EMC limit values required by this legislation (see Technical Data) presupposes observance of the "Description and Operating Instructions" and in particular the installation specifications indicated in Sections 4.3 - 4.5.

- ▶ Ensure adequate grounding of the PROFIBUS-Repeaters OZD Profi 12M ..., by providing a low-impedance, low-inductance connection between the top-hat rail or base plate and the local ground.
- ▶ Make exclusive use of shielded and twisted two-wire leads as RS 485 bus line.

In accordance with the above EU Directive, the EU Conformity Declarations are kept at the disposal of the appropriate authorities by:

Hirschmann Automation and Control GmbH  
Abteilung AM  
Stuttgarter Strasse 45 -51  
72654 Neckartenzlingen  
Germany

## 4.3 General information about setting up

Select the network topology which is most suitable for your requirements. The modules can then be put into operation in the following steps:

- ▶ Check and adjust (if necessary) the DIL switches. Note: The DIL switches may only be operated in an ambient temperature of between 0°C and +60°C. This also applies to the OZD Profi 12M G12-EEC.
- ▶ Mount the modules
- ▶ Connect the power supply and the signaling contacts
- ▶ Connect the electric RS 485 bus line with pre-mounted bus connector
- ▶ Connect the optical bus lines

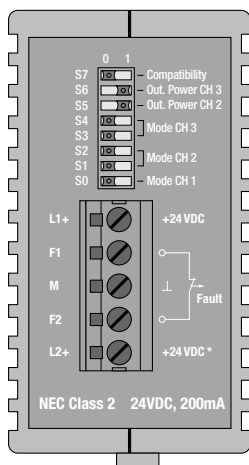

Fig. 5: Top view of the Module OZD Profi 12M – location of the DIL switches and terminal block for the operating power supply/signaling contacts. The illustration shows the factory settings of the DIL switches (switches S0, S1, S2, S3, S4 and S7 in Position "0", switches S5 and S6 in Position "1").



## 4.4 Setting compatibility, operating mode and transmitting power

### Please note:

The OZD Profi 12M ... must be switched off when changing the operating mode.  
You can switch off the OZD Profi 12M ... by, e.g., unplugging the 5-pin terminal block.

### 4.4.1 Setting the compatibility

The DIL switch S7 is used to switch the functional compatibility to devices of the preceding generation OZD Profi P3a, ... P4a, ... G3a, ... G4a, ... G3a-1300 and ... G4a-1300 either off or on. Default setting at S7 is Position 0 (compatibility is switched off).



**DIL switch S7 (compatibility) in Position 0:**  
**compatibility to**  
OZD Profi P3a, OZD Profi P4a,  
OZD Profi G3a, OZD Profi G4a,  
OZD Profi G3a-1300 and  
OZD Profi G4a-1300  
**switched off**



**DIL switch S7 (compatibility) in Position 1:**  
**compatibility to**  
OZD Profi P3a, OZD Profi P4a,  
OZD Profi G3a, OZD Profi G4a,  
OZD Profi G3a-1300 and  
OZD Profi G4a-1300  
**switched on**

The **functional compatibility** to OZD Profi modules of the preceding generation OZD Profi P3a, ... P4a, ... G3a, ... G4a, ... G3a-1300 and ... G4a-1300 is **switched on** with the **DIL switch S7=1**.

This operating mode is required when operating this module together with new devices.

Only turn switch S7 to Position 1 if the OZD Profi 12M ... is being used as a spare or expansion device in existing networks in conjunction with OZD Profi of the preceding generation, and a direct optical connection is to be made.

The following illustrations show the switch assignment of the OZD Profi 12M ... at S7=1 for

OZD Profi 12M P11,  
OZD Profi 12M P12:

S7 = 1 Compatibility Mode ON		
S0 Reserved		
S1	Mode	Monitor
0	Line/Ring	On
1	Line	Off
S2	Redundancy	
0	Off	
1	On	
S3,S4 Reserved		
S5	Output Power CH3	
0	Standard	
1	High	
S6	Output Power CH4	
0	Standard	
1	High	

OZD Profi 12M P11:  
S6 reserved

as a spare device for  
OZD Profi P3a  
and  
OZD Profi P4a

OZD Profi 12M ...  
G11, G12,  
G11-1300, G12-1300:

S7 = 1 Compatibility Mode ON		
S0 Reserved		
S1	Mode	Monitor
0	Line/Ring	On
1	Line	Off
S2	Redundancy	
0	Off	
1	On	
S3	Distance	
0	Extended	
1	Standard	
S4,S5,S6 Reserved		

OZD Profi 12M G11,  
OZD Profi 12M G11-1300:  
S2 reserved

as a spare device for  
OZD Profi G3a,  
OZD Profi G4a,  
OZD Profi G3a-1300  
and  
OZD Profi G4a-1300

### 4.4.2 Setting the operating mode

**Attention! The following details only apply for the S7 default position (S7 = 0)!**

The DIL switch **S0** is used to set the operating mode of the electrical port **CH1**.

The DIL switches **S1 and S2** are used to set the operating mode of the optical port **CH2**.

The DIL switches **S3 and S4** are used to set the operating mode of the optical port **CH3**.

S3 and S4 do not have a function on OZD Profi 12M ... with only one optical interface.

#### 4.4.2.1 Setting the operating mode of the electrical port (CH1)

**Operating mode "Electrical Port with segment monitoring"**

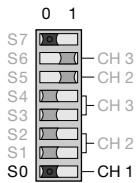

CH1 is activated in this operating mode if S0 is in Position 0.

**Operating mode "Electrical Port without segment monitoring"**

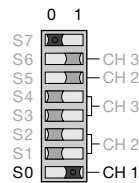

CH1 is activated in this operating mode if S0 is in Position 1. Please note that this operating mode should only be set in the star segment of the star topology.

#### 4.4.2.2 Setting the operating mode of the optical ports (CH2, CH3)

The operating mode can be set individually for each optical port. Combinations of the operating modes "Line with optical fiber link monitoring" and "Line without optical fiber link monitoring" are also possible.

Note that the operating mode of the two optical ports which are connected by the fiber line must always have the same settings!

The operating mode "Redundant optical ring" must always be set at both of the optical ports.

**Operating mode "Line with optical fiber link monitoring and segmentation"**

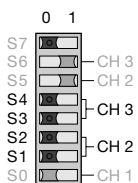

CH3 is activated in this operating mode if S3 and S4 are in Position 0.  
CH2 is activated in this operating mode if S1 and S2 are in Position 0.

**Operating mode "Line without optical fiber link monitoring"**

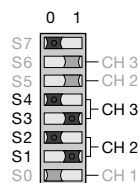

CH3 is activated in this operating mode if S3 is in Position 1 and S4 is in Position 0.  
CH2 is activated in this operating mode if S1 is in Position 1 and S2 is in Position 0.

### Operating mode "Redundant optical ring"

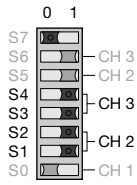

CH3 is activated in this operating mode if S3 and S4 are in Position 1.  
CH2 is activated in this operating mode if S1 and S2 are in Position 1.

Note: This operating mode must always be set at both of the optical ports of a module.

### 4.4.3 Reducing the optical transmitting power on the OZD Profi 12M P11 and OZD Profi 12M P12

**Attention! The following details only apply for the S7 default position (S7 = 0)!**

The OZD Profi 12M P11 and OZD Profi 12M P12 have a high level of optical transmitting power. Optical overloading may result if these modules are connected with non-OZD Profi devices using plastic optical fiber cables, particularly if short cable lengths are used. In this case the optical transmitting power can be reduced.

The DIL switch **S5** is used to set the transmitting power of **CH2**.

The DIL switch **S6** is used to set the transmitting power of **CH3**.

S6 does not have a function on the OZD Profi 12M P11.

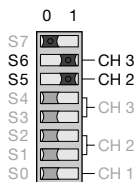

Leave S6 in Position 1 (default) if the optical fiber link to CH3 functions correctly in this position.  
Leave S5 in Position 1 (default) if the optical fiber link to CH2 functions correctly in this position.

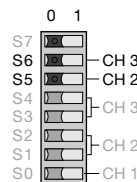

Switch S6 to Position 0 (reduced) if overloading is detected at a non-OZD Profi device when using plastic optical fiber cables to CH3.  
Switch S5 to Position 0 (reduced) if overloading is detected at a non-OZD Profi device when using plastic optical fiber cables to CH2.

#### Note:

The DIL switches S5 and S6 on the OZD Profi 12M ... for glass optical fiber cables do not have a function (the optical transmitting power cannot be reduced).

**The transmitting power default setting (S5 or S6 in Position 1) must be set when using PCF fibers.**

## 4.5 Installation

### 4.5.1 Installation guidelines

#### Electromagnetic compatibility (EMC)

Electromagnetic compatibility (EMC) covers all aspects regarding the effects of radiated and received electrical, magnetic, and electromagnetic emissions. In order to prevent interference in electrical systems, these effects must be reduced to a minimum.

The structural design and correct connection of bus lines as well as the interference suppression of switched inductances play a major role in limiting interference.

#### Interference suppression of switched inductances

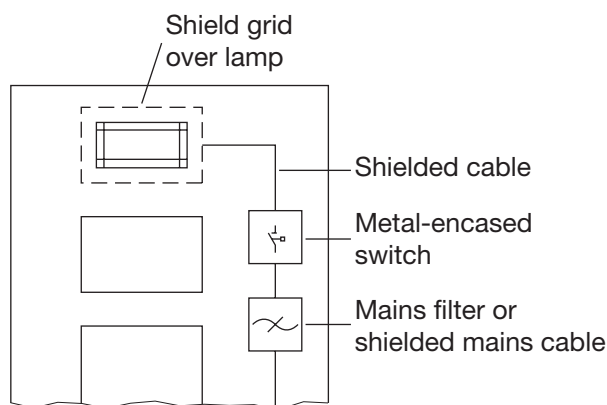

Fig. 6: Interference suppression of fluorescent lamps in cabinet

- Suppressing switched inductances with fuses: Switching inductances, e.g. in relays and fans, generates interference voltages which are many times higher than the switched operating voltage. These interference voltages can affect electronic devices. The interference voltages of inductances must be limited at their source of emission by means of fuses (by connecting diodes or RC elements). Only use interference suppressors which are intended for the used relays and fans.
- Cabinet lighting: Use filament lamps (e.g. LINSTRA lamps) for the cabinet lighting. Do not use fluorescent lamps because they generate interference fields. If the use of fluorescent lamps cannot be avoided, the interference suppression measures shown in Fig. 6 must be implemented.

#### Arrangement of devices and cables

- Reducing interference by providing adequate space: A simple yet effective way of reducing interference is to separate devices and cables causing interference from those affected by interference. Inductive and capacitive interference injection decreases by the square of the distance between the elements concerned. This means that doubling the distance reduces the interference by a factor of 4. If the arrangement of the various elements in a building or in the switch cabinet is taken into consideration at the planning stage, the cost of the necessary interference suppression measures is generally very low.
- Please note: Between an OZD Profi 12M ... and a power switching element (e.g. contactor, relay, temperature regulator, switch, etc.) a minimum separation of 15 cm is to be maintained. This minimum separation is to be measured between the outer edges of the components and in all directions around an OZD Profi 12M .... The power supply wires (+24 V DC and  $\perp$ ) for the OZD Profi 12M ... must not be laid in the same cable duct as cables for load circuits. The wires (+24V DC and  $\perp$ ) should be twisted together.

- Standard recommendations for the arrangement of devices and cables:  
EN 50174-2 contains recommendations for arranging devices and cables which are aimed at reducing mutual interference to a minimum.
- Using bus line shields:  
It is important to observe the following when shielding bus lines:
  - Use only fully shielded lines. The shields of these lines must be of sufficient thickness to satisfy the legal requirements for interference radiated and interference received.
  - Always attach the shields at both ends of the bus lines. The legal requirements vis-à-vis interference radiated and interference received for your system will only be satisfied if shields are connected at both ends (CE symbol).

- Attach the shield for the bus line at the connector plug housing or at the cable clamps provided.
- In the case of steady-state operation, it is advisable to strip the shielded line entirely and connect it with the shielding bus/protective conductor rail.

**Note:**

If differences in potential occur between the grounding points, an inadmissibly high compensating current could flow across the shielding connected at both ends. Never eliminate this problem by removing the shielding from the bus line!

The following solution is permissible:

Lay an additional equipotential bonding cable parallel to the bus line. This additional cable will carry the shield current.

**Shield connections**

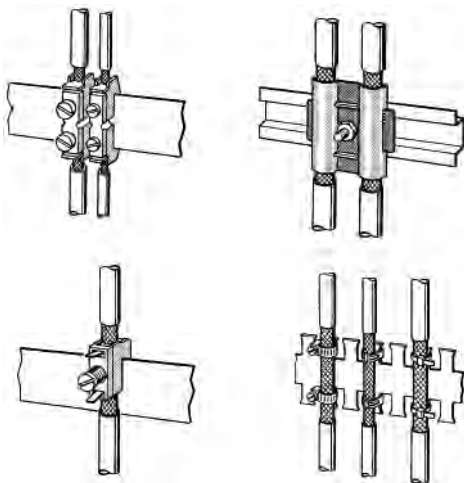

Fig. 7: Securing shielded lines using cable clamps and tube clips (schematic diagram)

Always observe the following points when installing bus line shielding:

- Secure the shield braid using metal cable clamps.
- The clamps must fully enclose the shield and make good contact (see Fig. 7).
- Only connect the lines via the copper braid shield, and not via the aluminum foil shield. One side of the foil shield is attached to a plastic film to increase its tearing strength, and is therefore non-conductive!
- The shields of all cables which are routed into a cabinet from the outside must be clamped at the point of entry inside the cabinet and connected to the cabinet ground with a large contact surface area.
- When removing the cable jackets, it is important to ensure that the braid shield of the cables is not damaged. Tin-plated or galvanically stabilized surfaces are ideal for optimum contacting between grounding elements. With zinc-plated surfaces, suitable threaded connections must be provided for the required contacts. Painted surfaces at the contact points are unsuitable.
- Shield clamps/contact points should not be used as strain relief devices. Contact with the shield bus could otherwise deteriorate or break completely.

### 4.5.2 Connecting the optical lines

- ▶ Connect the individual modules using a dual-fiber optical fiber line with BFOC/2.5 connectors.
- ▶ Ensure
  - that the end faces of the optical plugs are free of contamination.
  - that respectively one optical input  $\ominus$  and one optical output  $\ominus$  are connected to one another (crossover connection).
 The BFOC port sockets which belong to one other are marked on the bottom of the front plate.

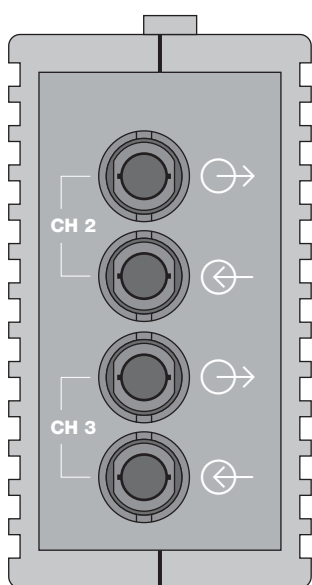

Fig. 8: View of the bottom of the module with the optical ports 2 and 3 (device with two optical ports).

### 4.5.3 Mounting the modules

The OZD Profi 12M ... modules can either be mounted on a 35 mm hat rail in accordance with DIN EN 50022 or directly on to a flat surface.

- ▶ Install the device in a location where the climatic and mechanical limit values defined in the Technical Data can be complied with.
- ▶ Ensure that there is sufficient room to connect the bus and power supply cabling.
- that the optical plugs on the BFOC socket are securely attached (bayonet fastener must be slotted in).
- that, with single-mode optical fiber, the BFOC plug spike is fully pushed into the optical fiber cable sockets. If necessary, make sure that the optical fibers are contacted correctly by gripping the reinforcing sleeve and pushing the connector into the socket.
- ▶ Ensure that there is sufficient strain relief on the optical fiber line, and pay attention to the minimum bend radius.
- ▶ Seal BFOC sockets which have not been assigned using the supplied protective caps (note: an optical port which has not been assigned should be switched to the operating mode "Line without optical fiber link monitoring" to avoid a break in the fiber line from being signaled). Extraneous ambient light can cause interference in the network, especially under very bright conditions. Optical components can be rendered useless if dust infiltrates them.
- ▶ Please note the maximum length of the optical fiber line and the possible fiber types which are shown in Table 1, p. 6 and in the Technical Data, p. 33.
- ▶ After installing the optical network, check the quality of the link using the measuring sockets. The measured values must be within the permissible range, as shown in Appendix 8.7 "Measuring sockets", Diagram 1, p.37.
- ▶ Connect the optical fiber line before mounting the module. This is easier than connecting it after the module has been installed.
- ▶ Only mount the module on a low-impedance and low-induction grounded hat rail or base plate. No other grounding measures are required.

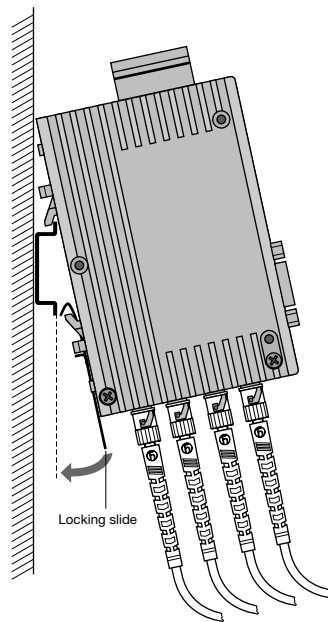

Fig. 9: Mounting a module on a standard hat rail

### Mounting on a hat rail

- ▶ Hang the top snap-in hooks of the module into the hat rail and press the underside onto the rail (as shown in Fig. 7) until it audibly clicks in.
- ▶ To remove the module, pull down on the locking slide.

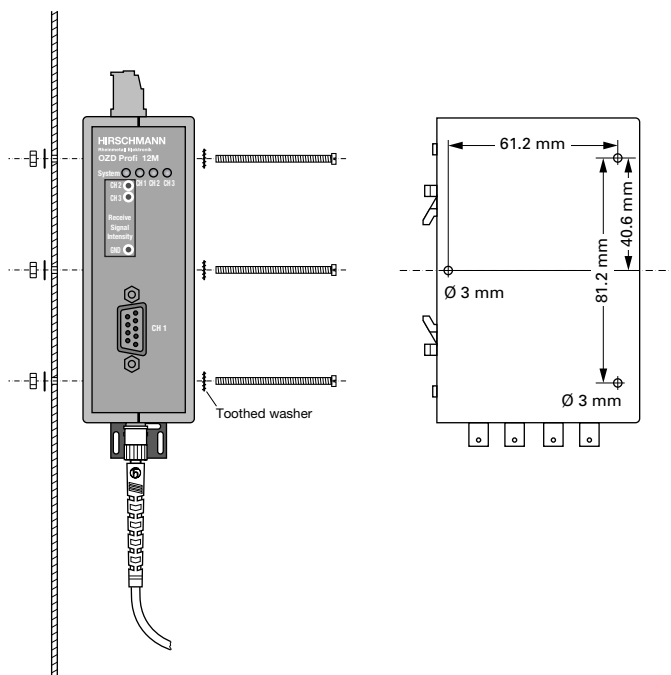

Fig. 10: Mounting a module on a mounting plate

### Mounting on a mounting plate

The modules have three through-holes. This allow it to be mounted on any flat surface, e.g. on the mounting plate of a switch cabinet.

- ▶ Drill three holes in the mounting plate corresponding to the drilling template in Fig. 8.
- ▶ Secure the modules with machine bolts (e.g. M 3 x 40).
- ▶ Ensure that there is a reliable electrical connection between the module housing and the mounting plate. Place toothed washers under the bolt heads to pierce the varnish.

#### 4.5.4 Connecting the electric RS 485 bus lines

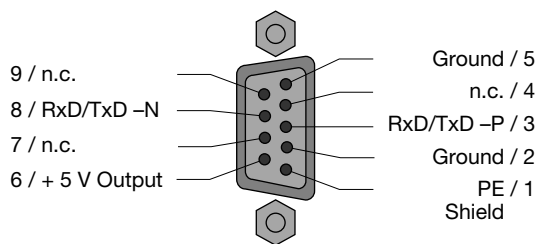

Fig. 11: Electrical port – assignment of Sub-D sockets

The modules are fitted with an RS 485 electrical port. This is a 9-pin Sub-D socket with a screw lock (inside thread UNC 4-40).

The pin assignment complies with the PROFIBUS standard. At Pin 6 there is a short circuit-proof 5 V output for supplying external pull-up/pull-down resistors.

As opposed to the 24V power supply, the RS 485 bus lines RxD/TxD-N and RxD/TxD-P are indirect-coupled (functional separation) within SELV restrictions.

The RS 485 interface is electrically connected to the housing.

- ▶ Only use shielded and twisted-pair wiring as a RS 485 bus line.
- ▶ Use a PROFIBUS bus connector plug to connect the RS 485 bus segment.

##### Notes:

- If the module is at the beginning or end of a bus segment, this connector must have an activated bus terminal resistor combination.
- Ensure that the bus segment connected to the RS 485 interface is terminated at both ends.
- Only use a connecting cable which is terminated at both ends to connect a single device.

- ▶ All PROFIBUS bus connector plugs in a network must be securely screwed onto the RS 485 interfaces.
- ▶ Attaching or removing the bus connector plugs, inadequately attached bus connector plugs or loose bus wires within the plug can lead to malfunctions in the optical and electrical networks.
- ▶ Attach or remove the RS 485 bus connector plug quickly and without twisting them.

- ▶ Remove the RS 485 bus line from the OZD Profi if a device is not connected to the other end, or there is an OZD Profi which has been disconnected from the power supply. The open line otherwise acts as an antenna and can cause interference.
- ▶ When connecting a RS 485 bus line to the OZD Profi 12M ... in an active network, keep to the following sequence in order to avoid interference:
  1. Place the RS 485 bus connector plug onto the device which is to be connected (e.g. to a programming device) and screw it on tightly.
  2. Attach the RS 485 bus connector plug to the OZD Profi 12M ... quickly and without twisting the connector, and screw it on tightly.
 Proceed in the reverse order when removing a device from the network.



##### Warning!

Do not connect any bus lines which have been partially or totally laid outside of buildings. Otherwise lightning strikes in the vicinity of the cable could destroy the module. Use optical fiber lines for bus connections which lead out of a building!!



### 4.5.5 Connecting the power supply

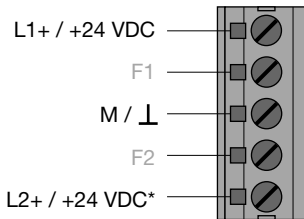

Fig. 12: Operating voltage supply – assignment of 5-pin terminal block

The terminal block can be removed from the device to connect the lines.

- ▶ The module should only be supplied with a regulated **safety extra-low voltage** in accordance with IEC 950/EN 60 950/VDE 0805 with a maximum of +32 VDC (typical +24 VDC). The power source must comply with the regulations of the NEC, Class 2 in accordance with UL/CSA approval.

It can be fed in using the 5-pin terminal block on the top of the module.

- ▶ To increase operational safety, the module can be redundantly supplied via the terminals L2+ / +24 VDC\* and M / ⊥.

In the event of a failure of the regular power supply, the module switches automatically to the redundant power supply. Load distribution between the individual alternative supply sources does not take place.

The signaling contact does not signal the failure of a single 24 V infeed. Both of the infeeds and the signaling contact must be connected to an input module for monitoring to take place.

Clips on the terminal block ensure that it is securely attached to the device, and simultaneously provide polarity reversal protection.

### 4.5.6 Connecting the signaling contact lines

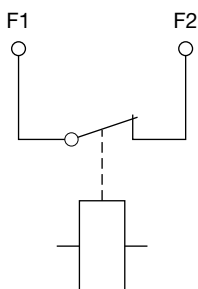

Fig. 13: Signaling contact - relay with unconnected contacts; the contact is open if a fault occurs

The terminal block can be removed from the device to connect the lines.

A relay with unconnected contacts as signaling contacts is fitted to the 5-pin terminal block on the top of the module. This signals faults and interference in the network and modules. The contact is open if a fault occurs. This also signals a total loss of power at the module.

Refer to Chapter 5.1 "LED indicators" p. 27 for more details about malfunctions which are signaled by the signaling contact.

Signaling contact limit values:

- maximum switching voltage 60 VDC; 42 VAC
- maximum switching current 1.0 A

The voltage connected to the relay must be regulated **safety extra-low voltage** in accordance with IEC 950/EN 60 950/ VDE 0805 and must comply with the regulations of the NEC, Class 2 in accordance with UL/CSA approval.

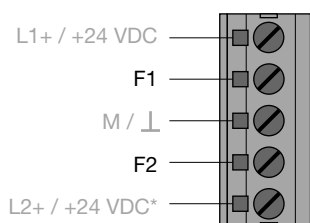

Fig. 14: Signaling contact – pin assignment 5-pin terminal block

- ▶ Pin assignment, 5-pin terminal block: terminals F1 and F2.
- ▶ Always ensure that the pins are correctly assigned at the 5-pin terminal block. Make sure that the connecting leads of the signaling contacts are adequately insulated, particularly if you are working with voltages greater than 32 V. Incorrect assignment can lead to destruction of the module.

### 4.5.7 Defining the receiving level of the optical ports

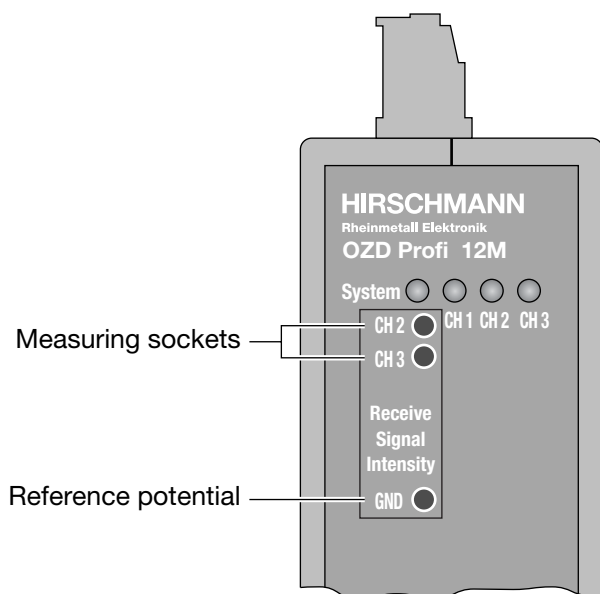

Fig. 15: Location of the measuring sockets

The receiving level of the two optical Ports CH2 and CH 3 can be measured using a conventional voltmeter connected to the measuring sockets. The voltmeter can be connected and disconnected while the module is in operation without any interference using 2 mm laboratory test plugs.

The OZD Profi 12M ... is protected against short circuits at the measuring sockets, although data transmission may be briefly disrupted.\*

With this

- the incoming optical performance can be documented, e.g. for later measurements (ageing, damage)
- a good/poor check can be carried out (limit value).

Further information can be found in Appendix 8.7 "Measuring sockets" p.37.

\* Only an ungrounded, high-resistance voltmeter may be used to take measurements.

The reference potential socket may not be connected to the OZD Profi 12M ... housing.

## 5 LED Indicators and Troubleshooting

### 5.1 LED Indicators

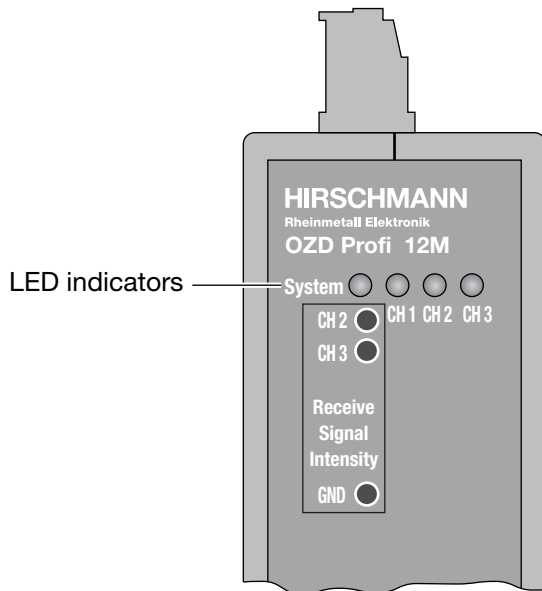

Fig. 16: LED indicators on the front plate

LED Indicator	Possible causes	Signaling contact
<b>System</b> <ul style="list-style-type: none"> <li>■ lights green</li> <li>■ not lit</li> <li>■ flashes red</li> <li>■ flashes red/green</li> </ul>	<ul style="list-style-type: none"> <li>– The transmission rate has been recognized and the power supply is in order</li> <li>– Power supply has failed (total failure*)</li> <li>– Power supply connected incorrectly</li> <li>– Module defective</li> </ul> <p>Transmission rate has not yet been recognized</p> <ul style="list-style-type: none"> <li>– No transmitting bus subscriber present</li> <li>– No connection to a partner module sending frames</li> <li>– Send and receive optical fibers have been transposed</li> <li>– Transmission rate does not correspond to the PROFIBUS standard</li> <li>– Only one active bus subscriber is connected, which is only sending tokens to itself. The indicator must switch over after a second bus subscriber has been activated (token frames on their own are not enough to set the transfer rate).</li> <li>– The connected RS 485 segment is only terminated at one end.</li> </ul> <p>Transmission rate recognized but</p> <ul style="list-style-type: none"> <li>– the network slot time could not be determined (network parameter HSA is set too low, no transmitting bus subscriber present)</li> <li>– one optical port is set to "Redundant optical ring" mode, but not the second (this operating mode must always be set at both optical ports)</li> <li>– the slot time of the network configuration is too short</li> </ul>	<ul style="list-style-type: none"> <li>  no signal</li> <li>  signal</li> <li>  no signal</li> <li>  no signal</li> </ul>

\* failure of both power supply sources with redundant infeed

LED Indicator	Possible causes	Signaling contact	
<b>CH1 electric</b>	<ul style="list-style-type: none"> <li>■ lights yellow</li> <li>■ not lit</li> </ul>	<p>Signals are being received on the RS 485 bus line</p> <ul style="list-style-type: none"> <li>– Bus subscriber is not connected</li> <li>– Connected bus subscriber is not switched on</li> <li>– One or both conductors in the RS 485 bus line is broken</li> </ul>	<p>no signal</p> <p>no signal</p>
	<ul style="list-style-type: none"> <li>■ flashes/lights red</li> </ul>	<p>Sporadic interference signals because</p> <ul style="list-style-type: none"> <li>– the RS 485 bus line being insufficiently shielded</li> <li>– an open RS 485 bus line, i.e. it is only connected to the module at one end</li> <li>– the RS 485 segment is not terminated or only terminated at one end</li> <li>– an RS 485 bus terminal or terminal connector has been plugged in/ pulled out</li> </ul> <p>Permanent interference because</p> <ul style="list-style-type: none"> <li>– conductors A and B in the RS 485 bus line have been transposed</li> <li>– of an RS 485 bus line short circuit</li> <li>– the send time has been exceeded caused by a bus subscriber in a bus segment connected to Port 1</li> <li>– module and another bus subscriber connected via Port 1 are both sending at the same time (e.g. because an address has been assigned twice, the setting of the slot time is too low, or during lifting of the segmentation in the optical line, see Chap. 3.1.1)</li> <li>– RS 485 driver of the module is defective (e.g. after lightning strike)</li> </ul>	<p>signal</p> <p>no signal</p>
<b>CH2, CH3 optical</b>	<ul style="list-style-type: none"> <li>■ lights yellow</li> </ul>	<p>PROFIBUS frames are being received at the optical port</p>	<p>no signal</p>
	<ul style="list-style-type: none"> <li>■ not lit</li> </ul>	<p><b>Operating mode "Line with optical fiber link monitoring" and "Redundant optical ring"</b></p> <p>Transmission rate has not yet been recognized – LED "System" flashes red</p> <ul style="list-style-type: none"> <li>– No transmitting bus subscriber present</li> <li>– Send and receive optical fibers have been transposed</li> <li>– No partner module connected or partner module is not switched on</li> <li>– Connected partner module is defective</li> </ul> <p>Transmission rate has been recognized - LED "System" flashes green</p> <ul style="list-style-type: none"> <li>– If the operating mode "Redundant optical ring" has been set, the optical port works as a stand-by port. There is no malfunction in the OZD Profi or the optical fiber.</li> <li>– If one of the operating modes "Line with optical fiber link monitoring ..." has been set, no PROFIBUS frames are received at the optical port. There is no malfunction in the OZD Profi or the optical fiber.</li> </ul>	<p>no signal</p>
	<ul style="list-style-type: none"> <li>■ flashes yellow</li> <li>■ lights red</li> </ul>	<p>Transmission rate has been recognized – LED "System" lights green or flashes red/green</p> <ul style="list-style-type: none"> <li>– No transmitting bus subscriber present (optical fiber connection is OK)</li> <li>– Send and receive optical fibers have been transposed</li> <li>– No partner module connected or partner module is not switched on</li> <li>– Connected partner module is defective</li> <li>– Send time of connected partner module has been exceeded</li> <li>– An optical fiber line is broken</li> <li>– Optical fiber link to partner module is too long</li> <li>– Loose connection in an optical fiber connector</li> <li>– Optical fiber in the optical fiber connector is loose</li> <li>– When using a redundant optical ring: if a fault in the optical fiber has been corrected but the port LEDs on both of the OZD Profi concerned still light red, check whether parameter HSA has been set as described the in Chap. 3.3.</li> </ul>	<p>no signal</p> <p>signal</p>
	<ul style="list-style-type: none"> <li>■ flashes red/yellow</li> </ul>	<ul style="list-style-type: none"> <li>– Fault occurs periodically (see above)</li> <li>– Loose connection in an optical fiber connector</li> <li>– Optical fiber in the optical fiber connector is loose</li> <li>– Only one active bus subscriber is connected, which only sends tokens to itself. A fault should not be signaled as soon as a second subscriber is activated.</li> </ul>	<p>signal</p>
<ul style="list-style-type: none"> <li>■ lights yellow</li> <li>■ not lit</li> </ul>	<p><b>Operating mode "Line without optical fiber link monitoring"</b></p> <p>Signals are received at the optical port.</p> <ul style="list-style-type: none"> <li>– No transmitting bus subscriber present</li> <li>– Send and receive optical fibers have been transposed</li> <li>– No partner module connected or partner module is not switched on</li> <li>– Connected partner module is defective</li> </ul>	<p>no signal</p> <p>no signal</p>	

Table 2: What the LED indicators and signaling contacts mean

## 5.2 Troubleshooting

This chapter helps you to localize faults after they have been indicated (by LEDs or signal contacts). Please also refer to the description of the LED indicators in 5.1, p. 27.

### Fault indicated on the system LED

See description of the LED indicators in 5.1, p. 27.

### Fault indicated on CH1

Check the following:

- ▶ the DIL switch S0 is in Position 1 if the OZD Profi connected to the electrical star segment of a star topology (see Chap. 3.2 "Star topology", p. 12).
- ▶ the fault is still displayed after removal of the RS485 connector.  
Still displayed: Device is defective\*.  
Replace the OZD Profi.  
No longer displayed: The fault lies in the RS485 bus segment.  
Check
  - all RS485 connectors as described in 4.5.4 "Connecting the electrical RS 485 bus lines", p. 24
  - the structure and shielding of the RS485 bus segment
  - the RS485 bus segment using a PROFIBUS bus monitor
  - the configuration of all bus subscribers.

\* This is not the case if the monomaster of a PROFIBUS network is connected to the RS485 bus segment which is to be examined. Replace the OZD Profi concerned with another OZD Profi from the network, and then carry out the test described above.

If the OZD Profi still malfunctions when connected elsewhere, the device is defective. Replace the OZD Profi.

If the OZD Profi does not malfunction elsewhere, the fault lies in the RS485 bus segment. Carry out the measures described above.

### Fault indicated on CH2 / CH3

1. Check the following:
  - ▶ optically only modules of the same type are connected together (see 3, "Network topologies", p. 9)
  - ▶ the optical fiber has been approved for the module type being used, and that it does not exceed the permitted length (see Table 1, p. 6)
  - ▶ the optical ports, which are connected via optical fibers, have been set to the same operating mode (see 4.4, "Setting compatibility, operating mode and transmitting power", p. 17)
  - ▶ the settings given in 4.5.2, "Connecting the optical lines" (p. 22) have been observed when connecting and laying the optical bus lines.
2. Define the optical receiving level (see 4.5.7 "Defining the receiving level of the optical ports", p. 26 and 8.7 "Measuring sockets", p. 37):
  - Level is in the range "Function is not guaranteed".
    - ▶ Check the optical fiber absorption using an optical level measuring device.
    - too high: replace the optical fiber
    - in valid range: one of the two OZD Profi of the disturbed optical fiber segments is defective. First replace the other OZD Profi of the disturbed optical fiber segments (i.e. the OZD Profi, which supplies the send signal for the measurement described above). If the fault still persists, replace the other OZD Profi instead.
  - Level is in the range "Optical system reserves reduced" or "Normal mode".
    - ▶ As described above, check the optical receiving level of the other OZD Profi in the disturbed optical fiber segment at the appropriate port.

- The levels at **both** OZD Profi of the disturbed optical fiber segments are in the range "Optical system reserves reduced" or "Normal mode": one of the two OZD Profi in the disturbed optical fiber segments is defective.
  - ▶ First replace one of the OZD Profi in the disturbed optical fiber segment. If the fault still persists, replace the other OZD Profi instead.

## 6 Configuration

During configuration, the PROFIBUS network parameter "Slot time" must be adapted to the network coverage, network topology and the data rate due to frame delays

caused by lines and network components, as well as by monitoring mechanisms in the network components.

### 6.1 Configuration of redundant optical rings

The following configuration conditions must be fulfilled in the redundant optical ring (for details see Chap. 3.3 "Redundant optical ring", p.13):

- (1) Configuration of a non-existent bus subscriber
- (2) Increasing the retry value to at least 3
- (3) Checking and adjusting the slot time

Use the user-specific profile of the configuration tool to set the parameters under (2) and (3).

Calculate the slot time with the following equation:

$$\text{Slot time} = a + (b \cdot \text{Length}_{\text{OF}}) + (c \cdot \text{Number}_{\text{OZD}})$$

- "Slot time" is the monitoring period in bit times
- "Length<sub>OF</sub>" is the sum of all the optical fiber lines (segment lengths) in the network.  
The length must be given in km!
- "Number<sub>OZD</sub>" is the number of OZD Profi 12M ... in the network.

The factors a, b and c are dependent on the transmission rate and are listed in the tables below.

Data rate	a	b	c
12 MBit/s <sup>1)</sup>	1651	240	28
6 MBit/s <sup>1)</sup>	951	120	24
3 MBit/s <sup>1)</sup>	551	60	24
1.5 MBit/s	351	30	24
500 kBit/s	251	10	24
187.5 kBit/s	171	3.75	24
93.75 kBit/s	171	1.875	24
45.45 kBit/s	851	0.909	24
19.2 kBit/s	171	0.384	24
9.6 kBit/s	171	0.192	24

Table 3a: Constants for calculating the slot time at DP standard (redundant optical ring)

Data rate	a	b	c
12 MBit/s <sup>1)</sup>	1651	240	28
6 MBit/s <sup>1)</sup>	951	120	24
3 MBit/s <sup>1)</sup>	551	60	24
1.5 MBit/s	2011	30	24
500 kBit/s	771	10	24
187.5 kBit/s	771	3.75	24
93.75 kBit/s	451	1.875	24
45.45 kBit/s	851	0.909	24
19.2 kBit/s	181	0.384	24
9.6 kBit/s	171	0.192	24

Table 3b: Constants for calculating the slot time at DP/FMS ("universal") and DP with S595U (redundant optical ring)

<sup>1)</sup> see p. 32

The calculation of the slot time only takes into consideration the optical network and the connection of bus subscribers to the OZD Profi via an RS 485 bus segment with a respective length of max. 20 m. Longer RS 485 bus segments must be allowed for by adding them to the  $Length_{OF}$ .

**Note:**

When the slot time is configured with a too small value the OZD Profi 12M ... will, through it's fault function and fault indications, indicate such. The System-LED will blink red/green.

<sup>1)</sup> Using the OZD Profi 12M G11-1300 (EEC) and ... G12-1300 (EEC) at data rates of 12 MBit/s, 6 MBit/s, 3 MBit/s and 1.5 MBit/s the minimum slot times according to the following table must be met.

Data rate	Minimum slot time
12 MBit/s	3800 $t_{Bit}$
6 MBit/s	2000 $t_{Bit}$
3 MBit/s	1000 $t_{Bit}$
1.5 MBit/s	530 $t_{Bit}$

*Table 4: Minimum slot time on OZD Profi 12M G11-1300 (EEC) and OZD Profi 12M G12-1300 (EEC)*

Use the values from Table 4 if the calculated slot time is smaller than the minimum slot time indicated in the table.



## 7 Technical Data

<b>OZD Profi 12M ...</b>	<b>P11 P12</b>	<b>G11 G12 G12-EEC</b>	<b>G11-1300 G12-1300 G12-1300 EEC</b>
<b>Voltage/power supply</b>			
Operating voltage	18 V to 32 VDC, typ. 24 VDC, (redundant inputs uncoupled), safety extra-low voltage, indirect-coupled		
Current consumption	max. 200 mA		
Output voltage/current for terminal resistors (Pin 6 Sub-D socket)	5 V + 5%, – 10%/90 mA; short circuit-proof		
Signaling contact			
Maximum switch voltage	60 VDC; 42 VAC (safety extra-low voltage)		
Maximum switch current	1.0 A		
<b>Signal transmission</b>			
Transmission rate	9.6; 19.2; 45.45; 93.75; 187.5; 500 kBit/s 1.5; 3; 6; 12 Mbit/s		
Setting transmission rate	automatic		
Bit error rate	$< 10^{-9}$		
Signal processing time (any input/output)	$\leq 6.5 t_{\text{Bit}}$		
<b>Retimer</b>			
Input Port 1 to 3			
Signal distortion	$\pm 30 \%$		
Bit length	$\pm 0.12 \%$		
Output Port 1 to 3			
Mean bit length	$\pm 0.01 \%$		
<b>Safety</b>			
VDE regulation	VDE 0805 = EN 60950 und IEC 60950		
UL/CSA approval	UL 1950/CSA 950		
FM approval	CLASS I: DIV 2 GROUP A; B; C und D; T5		
Ex approval	Ex nC [L] IIC T5; T <sub>A</sub> : 0 °C ... 60 °C		
<b>Electrical port</b>			
Input/output signal	RS 485 level		
Input dielectric strength	– 10 V to + 15 V		
PIN assignment, port 1	in accordance with EN 50170 Part 1		
<b>Optical ports</b>			
Wavelength	660 nm	860 nm	1310 nm
Launchable optical power			
– in glass fiber <b>E 10/125</b>	–	–	–19 dBm
– in glass fiber <b>G 50/125</b>	–	–15 dBm	–17 dBm
– in glass fiber <b>G 62.5/125</b>	–	–13 dBm	–17 dBm
– in PCF fiber <b>S 200/230</b>			
transmitting power "Reduced"	–	–	–
transmitting power "Default"	–17 dBm	–10 dBm	–
– in plastic fiber <b>S 980/1000</b>			
transmitting power "Reduced"	–10 dBm	–	–
transmitting power "Default"	–5 dBm	–	–
Receiver sensitivity	– 25 dBm	– 28 dBm	– 29 dBm
Receiver overload limit	– 3 dBm	– 3 dBm	– 3 dBm

<b>OZD Profi 12M ...</b>	<b>P11 P12</b>	<b>G11 G12 G12-EEC</b>	<b>G11-1300 G12-1300 G12-1300 EEC</b>
Transmission distance			
– with glass fiber <b>E 10/125</b> (0.5 dB/km)	–	–	0 - 15 000 m <sup>2)</sup>
– with glass fiber <b>G 50/125</b> (860 nm: 3.0 dB/km; 1310 nm: 1.0 dB/km)	–	0 - 3 000 m <sup>2)</sup>	0 - 10 000 m
– with glass fiber <b>G 62.5/125</b> (860 nm: 3.5 dB/km; 1310 nm: 1.0 dB/km)	–	0 - 3 000 m <sup>2)</sup>	0 - 10 000 m
– with PCF fiber <b>S 200/230</b> Transmitting power "Reduced"	–	–	–
Transmitting power "Default" (660 nm: 10.0 dB/km; 860 nm: 8.0 dB/km)	0 - 400 m <sup>2)</sup>	0 - 1000 m <sup>2)</sup>	–
– with plastic fiber <b>S 980/1000</b> Transmitting power "Reduced"	0 - 50 m	–	–
Transmitting power "Default" (0.2 dB/m)	0 - 80 m	–	–
Connector	BFOC/2.5		
<b>Electromagnetic compatibility (EMC)</b>			
Interference emissions	Limit class B (EN 55022)		
Interference immunity against static charges	At shielded socket and housing parts: ±8 kV contact discharge (EN 61000-4-2)		
Immunity against high-frequency interference	– 10 V/m at 80% amplitude modulation with 1 kHz, – 80 MHz - 1 GHz (EN 61000-4-3) – 10 V/m at 50% on-period at 900 MHz (ENV 50204) – 10 V/m at 80% amplitude modulation with 1 kHz, – 10 kHz - 80 MHz		
Immunity against line-conducted disturbance (Burst)	On power supply lines and shielded RS 485 bus lines: ±2 kV (EN 61000-4-4)		
Immunity against line-conducted disturbance (Surge)	– On power supply lines: ±1 kV symmetrical – On shielded RS 485 bus lines: ±2 kV asymmetrical (EN 61000-4-5)		
<b>Climatic ambient conditions</b>			
Ambient temperature (IEC 68-2-1, IEC 68-2-2)	0 °C to +60 °C –20 °C to +60 °C at OZD ... G12-EEC <sup>1)</sup> (IEC 68-2-1, IEC 68-2-2)		
Storage temperature	–40 °C to +70 °C (IEC 68-2-14)		
Relative humidity (IEC 68-2-30)	<95 %, non-condensing 100 %, condensing at OZD ... G12-EEC <sup>1)</sup> (IEC 68-2-30)		
<b>Mechanical ambient conditions</b>			
Vibration (during operation)	10 to 58 Hz, 0.075 mm displacement; 58 to 150 Hz, 10 m/s <sup>2</sup> (1 g) acceleration (IEC 68-2-6)		
Vibration (during transport)	5 to 9 Hz, 3.5 mm displacement; 9 to 500 Hz, 10 m/s <sup>2</sup> (1 g) acceleration		
Protection class	IP 40		
Dimensions (W x H x D)	40 x 111 x 73.5 mm		
Housing material	Die-cast zinc		
Weight	approx. 500 g		

1) The OZD Profi 12M G12 can also be supplied in a special design for more severe environmental conditions. This variant is designated the OZD Profi 12M G12-EEC.

The DIL switches on the OZD Profi 12M G12-EEC may also only be operated at ambient temperatures between 0°C and + 60°C.

2) The specified distance allowed between two OZD Profi must not be exceeded regardless of the optical power budget.

The module does not contain any silicon.

## 8 Appendix

### 8.1 FCC conformity

**Note:** This equipment has been tested and found to comply with the limits for a **Class B** digital device, pursuant to part 15 of the FCC Rules. These limits are designed to provide reasonable protection against harmful interference in a residential installation. This equipment generates, uses and can radiate radio frequency energy and, if not installed and used in accordance with the instructions, may cause harmful interference to radio communications. However, there is no guarantee that interference will not occur in a particular installation. If this equipment does cause harmful inter-

ference to radio or television reception, which can be determined by turning the equipment off and on, the user is encouraged to try to correct the interference by one or more of the following measures:

- Reorient or relocate the receiving antenna.
- Increase the separation between the equipment and receiver.
- Connect the equipment into an outlet on a circuit different from that to which the receiver is connected.
- Consult the dealer or an experienced radio/TV technician for help.

### 8.2 FM approval

FM 3611



INDUSTRIAL CONTROL EQUIPMENT  
FOR USE IN  
HAZARDOUS LOCATIONS  
CLASS I: DIV. 2  
GROUP A; B; C AND D

T5: T<sub>A</sub>: 0 °C ... 60 °C

### 8.3 Ex approval



II 3 G  
EEx nC [L] IIC T5

KEMA 00 ATEX 1141 X

### 8.4 UL/CSA approval



UL 1950/CSA 950

File Nr. E 168 643

## 8.5 C-Tick

### Australia / New Zealand



N13320

This product meets the requirements of the AS/NZS 3548 standard.

## 8.6 Literature notes

- Wrobel, Christoph (Herausgeber):  
„Optische Übertragungstechnik in industrieller Praxis“,  
Hüthig Buch Verlag GmbH, Heidelberg 1994
- G. Mahlke, P Gössig:  
„Lichtwellenleiterkabel: Grundlagen, Kabeltechnik“  
3. Auflage, Berlin 1992
- Technical directive:  
„Optische Übertragungstechnik für Profibus“,  
Publisher Profibus-Nutzerorganisation e. V.,  
Karlsruhe
- EN 50170-1-2 1996:  
„General Purpose Field Communication System“,  
Volume 2 „Physical Layer Spezification and Service  
Definition“
- DIN 19245:  
„Messen, Steuern, Regeln; PROFIBUS Teil 1;  
Process Field Bus; Übertragungstechnik, ...“  
„Messen, Steuern, Regeln; PROFIBUS Teil 3;  
Process Field Bus; Dezentrale Peripherie (DP)“
- EIA Standard RS-485 (April 1983):  
„Standard for electrical characteristics of generators“

## 8.7 List of abbreviations

BFOC	Bajonet Fiber Optic Connector	LED	Light Emitting Diode
DIN	Deutsche Industrie Norm (German Industrial Standard)	PCF	Polymer Cladded Fiber (equal to HCS™)
EEC	Extended Environmental Conditions	PNO	PROFIBUS Nutzer Organisation (PROFIBUS User Organization)
EIA	Electronic Industries Association	SELV	Secure Electrical Low Voltage
EN	Europäische Norm (European Standard)	UL	Underwriter Laboratories
EMC	Electromagnetic Compatibility	VDE	Verein Deutscher Elektroingenieure (Association of German Electrical Engineers)
HCS™	Hard Polymer Cladded Silica Fiber (registered trademark of Ensign-Bickford)		
IEC	International Electrotechnical Commission		

## 8.8 Measuring sockets

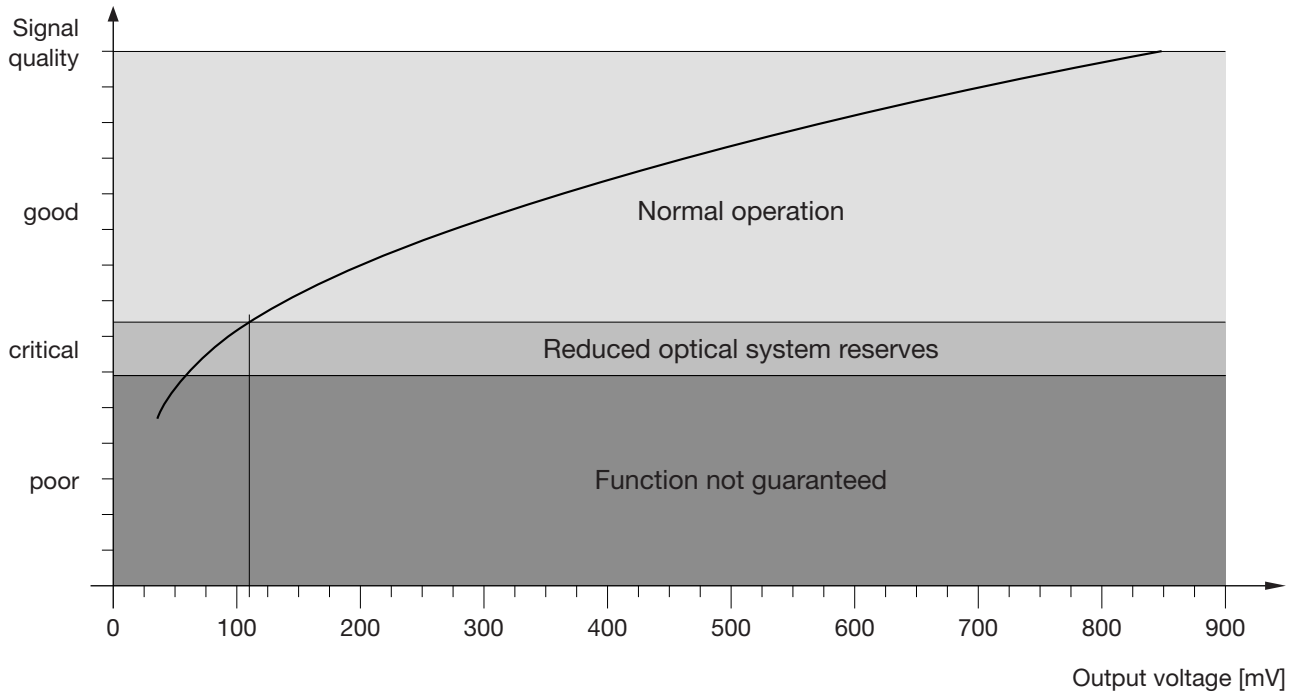

Diagram 1: Assignment of measured output voltage to signal quality.

### Notes:

In order to attain a valid reading, it is necessary for the partner OZD Profi at the other end of the optical fiber to send regular PROFIBUS frames. This can be seen on the LED display of the partner OZD Profi (see 5, "LED Indicators and Troubleshooting", p. 27).

The output voltage at the measuring sockets is subject to many influencing factors, such as:

- the strength of the transmitting power of the partner OZD Profi
- the ambient temperature of the optical sender and receiver
- attenuation of the transmitting link
- the transfer rates being used

The measuring sockets are therefore not intended as a substitute for a calibrated level measuring device with a calibrated light source.

The readings taken should only serve to classify the optical signal being received in the 3 classes

- good (normal operation)
- critical (reduced optical system reserves)
- poor (function not guaranteed)

Measurements must be taken with a conventional ungrounded and high-resistance voltmeter. A connection to the OZD Profi 12M ... housing is not permitted either from the measuring sockets or the reference potential.

## 9 Application Support

### **Contact address for technical support**

Hirschmann Automation and Control GmbH  
Stuttgarter Strasse 45 - 51  
72654 Neckartenzlingen  
Germany/Allemagne

Tel.: ++49 / 1805/ 14-1538

Fax: ++49 / 7127/ 14-1551

E-Mail: [ans-support@hirschmann.de](mailto:ans-support@hirschmann.de)

Internet: <http://www.hirschmann.com>



**HIRSCHMANN**

A Belden Company

Hirschmann Automation and Control GmbH  
Stuttgarter Strasse 45 - 51  
72654 Neckartenzlingen  
Germany/Allemagne

Tel.: +49 / 1805/ 14-1538

Fax: +49 / 7127/ 14-1551

E-Mail: [hac-support@hirschmann.de](mailto:hac-support@hirschmann.de)

Internet: <http://www.hirschmann.com>