

Temperature measuring transducer - MACX MCR-EX-T-UI-UP



2865654

<https://www.phoenixcontact.com/pc/products/2865654>

Please be informed that the data shown in this PDF document is generated from our Online Catalog. Please find the complete data in the user documentation. Our General Terms of Use for Downloads are valid.



Freely programmable Ex-i temperature transducer with analog output and 1 limit value relay, standard configuration, resistance thermometer in 2-, 3-, or 4-conductor technology, thermocouples, electrical isolation, wide-range power supply, screw connection, SIL, PL.

Your advantages

- Input for resistance thermometers, thermocouples, resistance-type sensors, potentiometers, and mV sources, [Ex ia] IIC
- Programming during operation with Ex measuring circuit connected and also voltage-free using IFS-USB-PROG-ADAPTER programming adapter
- Cold junction compensation with separate plug
- Configuration via software (FDT/DTM) or IFS-OP-UNIT operator interface and display unit
- Installation in zone 2, protection type "n" (EN 60079-15) permitted
- Up to SIL 2 in accordance with EN 61508
- Status indicator for supply voltage, cable, sensor, and module errors
- Plug-in screw or spring-cage connection technology (Push-in technology)
- Wide-range power supply of 19.2 ... 253 V AC/DC
- Measure differential temperatures
- Inverse output signal ranges as an option
- Relay switching output
- Freely programmable input and output

Commercial Data

Item number	2865654
Packing unit	1 pc
Minimum order quantity	1 pc
Product Key	CK3121
Catalog Page	Page 150 (C-5-2019)
GTIN	4046356296670
Weight per Piece (including packing)	264.1 g
Weight per Piece (excluding packing)	264.1 g
Customs tariff number	85437090
Country of origin	DE

Temperature measuring transducer - MACX MCR-EX-T-UI-UP



2865654

<https://www.phoenixcontact.com/pc/products/2865654>

Technical Data

Notes

Utilization restriction

EMC note	EMC: class A product, see manufacturer's declaration in the download area
----------	---

Product properties

Product type	Temperature transmitter
Type	Ex i signal conditioners with SIL and PL Functional Safety
Configuration	DIP switches
	Software

Insulation characteristics

Overvoltage category	II
Pollution degree	2

Electrical properties

Electrical isolation	4-way isolation
Step response (0–99%)	≤ 1.75 s (SIL on)
	1.3 s (SIL off)
Maximum temperature coefficient	0.01 %/K
Maximum transmission error	0.1 % (E.g., at Pt 100, 300 K min. span)

Electrical isolation Input/output/power supply

Test voltage	2.5 kV AC (50 Hz, 60 s)
--------------	-------------------------

Electrical isolation Input/output

Electrical isolation	375 V (Peak value in accordance with IEC/EN 60079-11)
----------------------	---

Electrical isolation Input/power supply

Electrical isolation	375 V (Peak value in accordance with IEC/EN 60079-11)
----------------------	---

Electrical isolation Input/switching output

Electrical isolation	375 V (Peak value in accordance with IEC/EN 60079-11)
----------------------	---

Electrical isolation Output/supply

Rated insulation voltage	300 V _{rms}
Insulation	Safe isolation in accordance with IEC/EN 61010-1

Supply

Nominal supply voltage range	24 V AC/DC ... 230 V AC/DC (50/60 Hz)
Supply voltage range	19.2 V AC/DC ... 253 V AC/DC (24 V AC/DC ... 230 V AC/DC (-20 % ... +10 %, 50/60 Hz))
Typical current consumption	< 50 mA (24 V DC)
Power consumption	< 1.5 W

Temperature measuring transducer - MACX MCR-EX-T-UI-UP



2865654

<https://www.phoenixcontact.com/pc/products/2865654>

Input data

Signal:

Number of inputs	1
Input signal	Temperature
	Resistor
	Voltage

Measurement

Sensor types (RTD) that can be used	Pt, Ni, Cu sensors: 2, 3, 4-wire
Sensor types that can be used (TC)	B, E, J, K, N, R, S, T, L, U, CA, DA, A1G, A2G, A3G, MG, LG
Temperature measuring range	-250 °C ... 2500 °C (Range depending on the sensor type)
Linear resistance measuring range	0 Ω ... 50 kΩ
Potentiometer resistance range	0 Ω ... 50 kΩ
Linear mV signal range	-1000 mV ... 1000 mV

Output data

Switching: Relay

Configurable/programmable	Yes
Contact type	1 changeover contact
Contact material	AgSnO ₂ , hard gold-plated
Maximum switching voltage	30 V AC (30 V DC)
Maximum inrush current	0.5 A (30 V AC)
	1 A (30 V DC)

Signal: Current

Number of outputs	1
Configurable/programmable	Yes
Max. voltage output signal	± 11 V
Current output signal	4 mA ... 20 mA (in the case of SIL; further free configuration without SIL)
Max. current output signal	22 mA
Load/output load voltage output	≥ 10 kΩ
Load/output load current output	≤ 600 Ω (20 mA)
Behavior in the event of a sensor error	according to NE 43 or freely configurable

Connection data

Connection method	Screw connection
Stripping length	7 mm
Screw thread	M3
Conductor cross section solid	0.2 mm ² ... 2.5 mm ²
Conductor cross section flexible	0.2 mm ² ... 2.5 mm ²
Conductor cross section AWG	24 ... 14
Tightening torque	0.5 Nm ... 0.6 Nm

Temperature measuring transducer - MACX MCR-EX-T-UI-UP



2865654

<https://www.phoenixcontact.com/pc/products/2865654>

Ex data

Safety data

Max. internal inductance L_i	negligible
Max. internal capacitance C_i	44 nF
Max. output voltage U_o	6 V DC
Max. output current I_o	7 mA (RTD in 2-conductor technology)
	13 mA (RTD in 3-conductor technology)
	16 mA (RTD in 4-conductor technology)
	13 mA (TC with internal cold junction compensation)
	10 mA (TC with external cold junction compensation)
	5 mA (mV)
	13 mA (Potentiometer)
Max. output power P_o	11 mW (RTD in 2-conductor technology)
	20 mW (RTD in 3-conductor technology)
	24 mW (RTD in 4-conductor technology)
	20 mW (TC with internal cold junction compensation)
	15 mW (TC with external cold junction compensation)
	7.5 mW (mV)
	20 mW (Potentiometer)
IIC (mixed circuit): Max. external inductivity L_o / Max. external capacitance C_o	100 mH / 600 nF
IIB/IIA/IIIC (mixed circuit): Max. external inductivity L_o / Max. external capacitance C_o	100 mH / 1 μ F

LED signaling

Status display	Green LED (supply voltage, PWR)
	Red LED, flashing (line, sensor error, ERR)
	Red LED (module error, ERR)
	Yellow LED (switching output)

Dimensions

Width	17.5 mm
Height	112.5 mm
Depth	113.7 mm
Depth NS 35/7,5	114.5 mm (Snapped onto DIN rail NS 35/7,5 in accordance with EN 60715)

Material specifications

Flammability rating according to UL 94	V0 (Housing)
Housing material	PA 6.6-FR

Environmental and real-life conditions

Ambient conditions

Temperature measuring transducer - MACX MCR-EX-T-UI-UP



2865654

<https://www.phoenixcontact.com/pc/products/2865654>

Degree of protection	IP20 (not assessed by UL)
Ambient temperature (operation)	-20 °C ... 65 °C
Ambient temperature (storage/transport)	-40 °C ... 85 °C
Permissible humidity (operation)	typ. 5 % ... 95 % (non-condensing)
Shock	15g, according to IEC 60068-2-27
Vibration (operation)	5g, accordance to IEC 60068-2-6

Approval data

CE

Certificate	CE-compliant
-------------	--------------

ATEX

Identification	<input type="checkbox"/> II (1) G [Ex ia Ga] IIC
	<input type="checkbox"/> II (1) D [Ex ia Da] IIIC
	<input type="checkbox"/> II 3 G Ex ec ic nC [ia Ga] IIC T4 Gc
	<input type="checkbox"/> I (M1) [Ex ia Ma] I
Certificate	IBExU 10 ATEX 1044

IECEX

Identification	[Ex ia Ga] IIC
	[Ex ia Da] IIIC
	Ex ec ic nC [ia Ga] IIC T4 Gc
	[Ex ia Ma] I
Certificate	IECEX IBE 10.0004 X

UL, USA / Canada

Identification	UL 508 Listed
Certificate	<input type="checkbox"/> , C.D.-No 83104549

KC-s

Identification	[Ex ia] IIC/IIB
Certificate	17-KA4BO-0411X

Shipbuilding approval

Certificate	DNV GL TAA000020C
-------------	-------------------

Safety Integrity Level (SIL, IEC 61508)

Identification	2
Certificate	SEBS-A.150520/17TB

Performance Level (ISO 13849)

Identification	d
----------------	---

EAC Ex

Identification	<input type="checkbox"/> [Ex ia Ga] IIC
	<input type="checkbox"/> [Ex ia Da] IIIC
Certificate	RU C-DE.AB72.B.00093/19

Temperature measuring transducer - MACX MCR-EX-T-UI-UP



2865654

<https://www.phoenixcontact.com/pc/products/2865654>

INMETRO

Identification	[Ex ia Ga] IIC
	[Ex ia Da] IIIC
	Ex nA nC ic IIC T4 Gc
Certificate	DNV 18.0143 X

DNV GL data

Temperature	B
Humidity	B
Vibration	A
EMC	A
Enclosure	Required protection according to the Rules shall be provided upon installation on board

EMC data

Electromagnetic compatibility	Conformance with EMC directive
Noise emission	EN 61000-6-4
Noise immunity	EN 61000-6-2
Note	When being exposed to interference, there may be minimal deviations.

Electromagnetic HF field

Designation	Electromagnetic RF field
Standards/regulations	EN 61000-4-3
Typical deviation from the measuring range final value	2 %

Fast transients (burst)

Designation	Fast transients (burst)
Standards/regulations	EN 61000-4-4
Typical deviation from the measuring range final value	2 %

Conducted interference

Designation	Conducted interferences
Standards/regulations	EN 61000-4-6
Typical deviation from the measuring range final value	2 %

Standards and regulations

Electrical isolation	4-way isolation
----------------------	-----------------

Mounting

Mounting type	DIN rail mounting
---------------	-------------------

Temperature measuring transducer - MACX MCR-EX-T-UI-UP

2865654

<https://www.phoenixcontact.com/pc/products/2865654>

Drawings

Block diagram

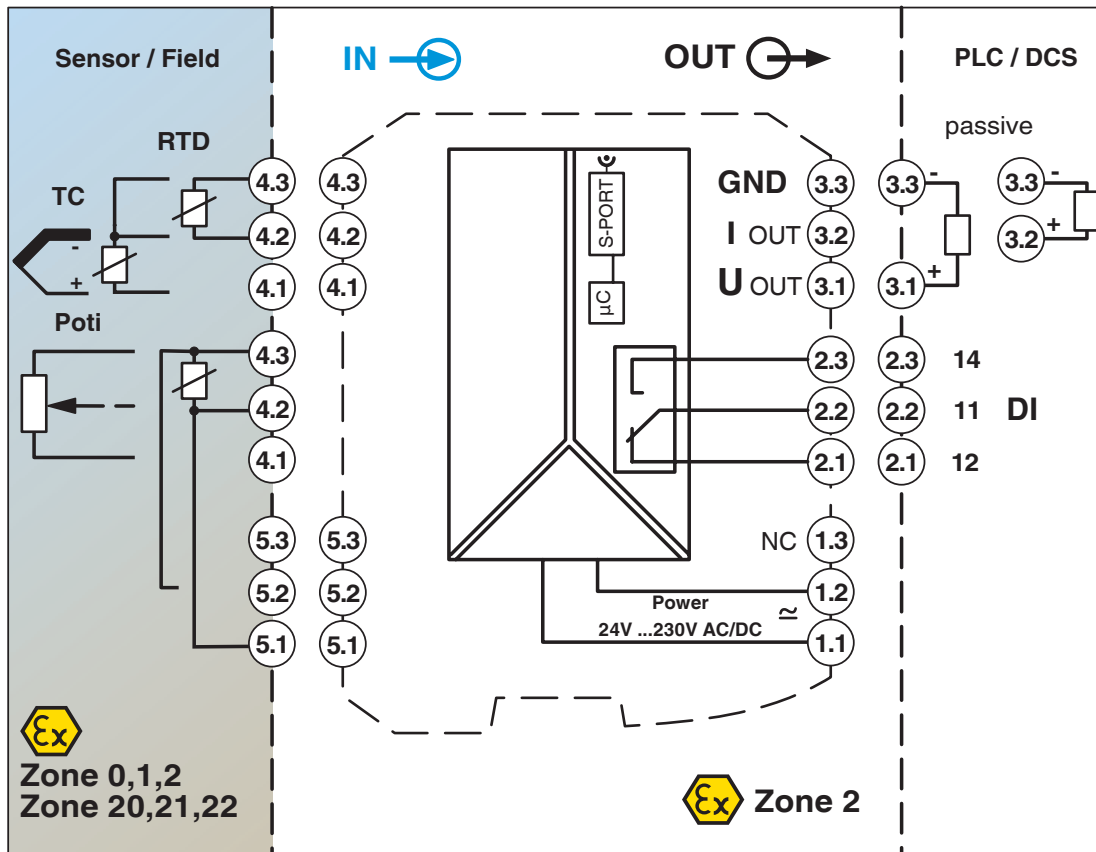

Temperature measuring transducer - MACX MCR-EX-T-UI-UP



2865654

<https://www.phoenixcontact.com/pc/products/2865654>

Approvals



DNV GL

Approval ID: TAA000020C



UL Listed

Approval ID: FILE E 238705



cUL Listed

Approval ID: FILE E 238705



Functional Safety

Approval ID: SEBS-A.150520/17 V1

Functional Safety

Approval ID: 09/11-04 R013 V1R0

Functional Safety

Approval ID: 100134C P0019 C001



EAC Ex

Approval ID: RU C-DE.AB72.B.00093



IECEx

Approval ID: IECEx IBE 10.0004X



cUL Listed

Approval ID: FILE E 199827



UL Listed

Approval ID: FILE E 199827



ATEX

Approval ID: IBExU 10 ATEX 1044

INMETRO

Approval ID: DNV 18.0143 X

Temperature measuring transducer - MACX MCR-EX-T-UI-UP



2865654

<https://www.phoenixcontact.com/pc/products/2865654>

KC-s

Approval ID: 17-KA4BO-0411X

cULus Listed

cULus Listed

Temperature measuring transducer - MACX MCR-EX-T-UI-UP



2865654

<https://www.phoenixcontact.com/pc/products/2865654>

Classifications

ECLASS

ECLASS-9.0	27210129
ECLASS-10.0.1	27210129
ECLASS-11.0	27210129

ETIM

ETIM 8.0	EC002919
----------	----------

UNSPSC

UNSPSC 21.0	41112100
-------------	----------

Temperature measuring transducer - MACX MCR-EX-T-UI-UP



2865654

<https://www.phoenixcontact.com/pc/products/2865654>

Environmental Product Compliance

REACH SVHC	Lead 7439-92-1
China RoHS	Environmentally Friendly Use Period = 50 years
	For information on hazardous substances, refer to the manufacturer's declaration available under "Downloads"

Temperature measuring transducer - MACX MCR-EX-T-UI-UP

2865654

<https://www.phoenixcontact.com/pc/products/2865654>

Accessories

Power and error message module

Power and error message module - MACX MCR-PTB - 2865625

<https://www.phoenixcontact.com/pc/products/2865625>



Power and fault signaling module with screw connection, including corresponding ME 17,5 TBUS 1,5/ 5-ST-3,81 GY DIN rail connector

Power and error message module

Power and error message module - MACX MCR-PTB-SP - 2924184

<https://www.phoenixcontact.com/pc/products/2924184>



Power and fault signaling module with Push-in connection, including corresponding ME 17,5 TBUS 1,5/ 5-ST-3,81 GY DIN rail connector

Temperature measuring transducer - MACX MCR-EX-T-UI-UP



2865654

<https://www.phoenixcontact.com/pc/products/2865654>

Power supply unit

Power supply unit - QUINT4-SYS-PS/1AC/24DC/2.5/SC - 2904614

<https://www.phoenixcontact.com/pc/products/2904614>



Primary-switched power supply unit, QUINT POWER, Screw connection, DIN rail mounting, input: 1-phase, output: 24 V DC / 2.5 A

Programming adapter

Programming adapter - IFS-USB-PROG-ADAPTER - 2811271

<https://www.phoenixcontact.com/pc/products/2811271>



Programming adapter with USB interface, for programming with software. The USB driver is included in the software solutions for the products to be programmed, such as measuring transducers or motor managers.

Temperature measuring transducer - MACX MCR-EX-T-UI-UP

2865654

<https://www.phoenixcontact.com/pc/products/2865654>

Plug

Plug - MACX MCR-EX-I20 - 2905679

<https://www.phoenixcontact.com/pc/products/2905679>

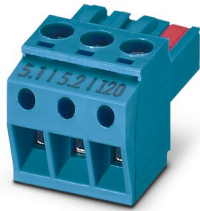

Connection terminal block for current signals +20 mA ...-20 mA for safe switching of limit values, in combination with MACX...EX-T-UI... temperature transducers.

Plug

Plug - MACX MCR-EX-CJC - 2925002

<https://www.phoenixcontact.com/pc/products/2925002>



Plug for cold junction compensation for thermocouples, for safe switching of limit values, in combination with MACX ...EX-T-UI... temperature transducers.

Temperature measuring transducer - MACX MCR-EX-T-UI-UP

2865654

<https://www.phoenixcontact.com/pc/products/2865654>

Adapter

Adapter - IFS-BT-PROG-ADAPTER - 2905872

<https://www.phoenixcontact.com/pc/products/2905872>

Bluetooth adapter with micro USB and S-PORT interface for wireless communication with the MINI Analog, MINI Analog Pro, MACX Analog, INTERFACE system gateways, and PLC logic device series.



Insulating sleeve

Insulating sleeve - MPS-IH WH - 0201663

<https://www.phoenixcontact.com/pc/products/0201663>

Insulating sleeve, color: white



Temperature measuring transducer - MACX MCR-EX-T-UI-UP

2865654

<https://www.phoenixcontact.com/pc/products/2865654>

Insulating sleeve

Insulating sleeve - MPS-IH RD - 0201676

<https://www.phoenixcontact.com/pc/products/0201676>

Insulating sleeve, color: red



Insulating sleeve

Insulating sleeve - MPS-IH BU - 0201689

<https://www.phoenixcontact.com/pc/products/0201689>

Insulating sleeve, color: blue

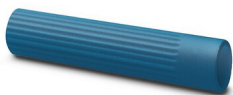

Temperature measuring transducer - MACX MCR-EX-T-UI-UP

2865654

<https://www.phoenixcontact.com/pc/products/2865654>

Insulating sleeve

Insulating sleeve - MPS-IH YE - 0201692

<https://www.phoenixcontact.com/pc/products/0201692>

Insulating sleeve, color: yellow



Insulating sleeve

Insulating sleeve - MPS-IH GN - 0201702

<https://www.phoenixcontact.com/pc/products/0201702>

Insulating sleeve, color: green



Temperature measuring transducer - MACX MCR-EX-T-UI-UP

2865654

<https://www.phoenixcontact.com/pc/products/2865654>

Insulating sleeve

Insulating sleeve - MPS-IH GY - 0201728

<https://www.phoenixcontact.com/pc/products/0201728>

Insulating sleeve, color: gray



Insulating sleeve

Insulating sleeve - MPS-IH BK - 0201731

<https://www.phoenixcontact.com/pc/products/0201731>

Insulating sleeve, color: black



Temperature measuring transducer - MACX MCR-EX-T-UI-UP



2865654

<https://www.phoenixcontact.com/pc/products/2865654>

Test plugs

Test plugs - MPS-MT - 0201744

<https://www.phoenixcontact.com/pc/products/0201744>



Test plugs, with solder connection up to 1 mm² conductor cross section, color: gray

Plastic label

Plastic label - UC-EMLP (11X9) - 0819291

<https://www.phoenixcontact.com/pc/products/0819291>



Plastic label, Sheet, white, unlabeled, can be labeled with: BLUEMARK ID COLOR, BLUEMARK ID, BLUEMARK CLED, PLOTMARK, CMS-P1-PLOTTER, mounting type: adhesive, lettering field size: 11 x 9 mm, Number of individual labels: 10

Temperature measuring transducer - MACX MCR-EX-T-UI-UP

2865654

<https://www.phoenixcontact.com/pc/products/2865654>

Plastic label

Plastic label - UC-EMLP (11X9) YE - 0822602

<https://www.phoenixcontact.com/pc/products/0822602>

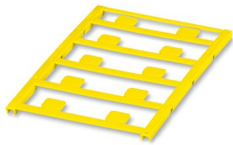

Plastic label, Sheet, yellow, unlabeled, can be labeled with: BLUEMARK ID COLOR, BLUEMARK ID, BLUEMARK CLED, PLOTMARK, CMS-P1-PLOTTER, mounting type: adhesive, lettering field size: 11 x 9 mm, Number of individual labels: 10

Plastic label

Plastic label - UC-EMLP (11X9) CUS - 0824547

<https://www.phoenixcontact.com/pc/products/0824547>



Plastic label, can be ordered: by sheet, white, labeled according to customer specifications, mounting type: adhesive, lettering field size: 11 x 9 mm

Temperature measuring transducer - MACX MCR-EX-T-UI-UP

2865654

<https://www.phoenixcontact.com/pc/products/2865654>

Plastic label

Plastic label - UC-EMLP (11X9) YE CUS - 0824548

<https://www.phoenixcontact.com/pc/products/0824548>

Plastic label, can be ordered: by sheet, yellow, labeled according to customer specifications, mounting type: adhesive, lettering field size: 11 x 9 mm

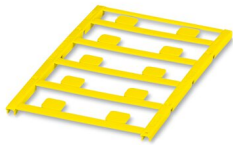

Plastic label

Plastic label - UC-EMLP (11X9) SR - 0828094

<https://www.phoenixcontact.com/pc/products/0828094>

Plastic label, Sheet, silver, unlabeled, can be labeled with: BLUEMARK ID COLOR, BLUEMARK ID, BLUEMARK CLED, PLOTMARK, CMS-P1-PLOTTER, mounting type: adhesive, lettering field size: 11 x 9 mm, Number of individual labels: 10



Temperature measuring transducer - MACX MCR-EX-T-UI-UP

2865654

<https://www.phoenixcontact.com/pc/products/2865654>

Plastic label

Plastic label - UC-EMLP (11X9) SR CUS - 0828098

<https://www.phoenixcontact.com/pc/products/0828098>



Plastic label, can be ordered: by sheet, silver, labeled according to customer specifications, mounting type: adhesive, lettering field size: 11 x 9 mm, Number of individual labels: 10

Plastic label

Plastic label - US-EMLP (11X9) - 0828789

<https://www.phoenixcontact.com/pc/products/0828789>



Plastic label, Card, white, unlabeled, can be labeled with: BLUEMARK ID COLOR, BLUEMARK ID, THERMOMARK PRIME, THERMOMARK CARD 2.0, THERMOMARK CARD, mounting type: adhesive, lettering field size: 11 x 9 mm, Number of individual labels: 135

Temperature measuring transducer - MACX MCR-EX-T-UI-UP

2865654

<https://www.phoenixcontact.com/pc/products/2865654>

Plastic label

Plastic label - US-EMLP (11X9) YE - 0828871

<https://www.phoenixcontact.com/pc/products/0828871>



Plastic label, Card, yellow, unlabeled, can be labeled with: BLUEMARK ID COLOR, BLUEMARK ID, THERMOMARK PRIME, THERMOMARK CARD 2.0, THERMOMARK CARD, mounting type: adhesive, lettering field size: 11 x 9 mm, Number of individual labels: 135

Plastic label

Plastic label - US-EMLP (11X9) SR - 0828872

<https://www.phoenixcontact.com/pc/products/0828872>



Plastic label, Card, silver, unlabeled, can be labeled with: BLUEMARK ID COLOR, BLUEMARK ID, THERMOMARK PRIME, THERMOMARK CARD 2.0, THERMOMARK CARD, mounting type: adhesive, lettering field size: 11 x 9 mm, Number of individual labels: 135

Temperature measuring transducer - MACX MCR-EX-T-UI-UP



2865654

<https://www.phoenixcontact.com/pc/products/2865654>

Device marker

Device marker - LS-EMLP (11X9) WH - 0831678

<https://www.phoenixcontact.com/pc/products/0831678>

Device marker, Sheet, white, unlabeled, can be labeled with: TOPMARK NEO, TOPMARK LASER, mounting type: adhesive, lettering field size: 11 x 9 mm, Number of individual labels: 255



Device marker

Device marker - LS-EMLP (11X9) SR - 0831705

<https://www.phoenixcontact.com/pc/products/0831705>

Device marker, Sheet, silver, unlabeled, can be labeled with: TOPMARK NEO, TOPMARK LASER, mounting type: adhesive, lettering field size: 11 x 9 mm, Number of individual labels: 255

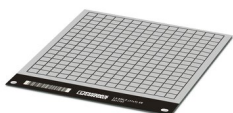

Temperature measuring transducer - MACX MCR-EX-T-UI-UP



2865654

<https://www.phoenixcontact.com/pc/products/2865654>

Device marker

Device marker - LS-EMLP (11X9) YE - 0831732

<https://www.phoenixcontact.com/pc/products/0831732>

Device marker, Sheet, yellow, unlabeled, can be labeled with: TOPMARK NEO, TOPMARK LASER, mounting type: adhesive, lettering field size: 11 x 9 mm, Number of individual labels: 255

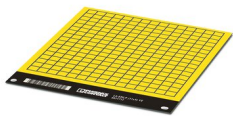

Phoenix Contact 2022 © - all rights reserved

<https://www.phoenixcontact.com>

PHOENIX CONTACT GmbH & Co. KG

Flachsmarktstraße 8

D-32825 Blomberg

+49 (0) 5235-3 00

info@phoenixcontact.com