



LIGHTING FOREVER

4 PIN SOP RANDOM-PHASE TRIAC PHOTOCOUPLER

ELM302X Series
ELM305X Series

Features:

- EL302X V_{DRM} of 400V, EL305X V_{DRM} of 600V
- High isolation voltage between input and output ($V_{iso}=3750$ V rms)
- Compact dual-in-line package
- Pb free and RoHS compliant.
- cUL approved (No. E214129)
- VDE approved (No. 40028116))
- SEMKO approved
- NEMKO approved
- DEMKO approved
- FIMKO approved



Schematic

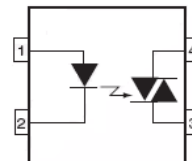

Description

The ELM302X series and ELM305X series are optically isolated triac driver devices. These devices contain a GaAs infrared emitting diode and a light activated silicon bilateral switch, which functions like a triac.

They are designed for interfacing between electronic controls and power triacs to control resistive and inductive loads for 115 to 240 VAC operations.

Applications

- Solenoid/valve controls
- Lamp ballasts
- Static AC power switch
- Interfacing microprocessors to 115 to 240Vac peripherals
- Incandescent lamp dimmers
- Temperature controls
- Motor controls

Pin Configuration

1. Anode
2. Cathode
3. Terminal
4. Terminal



LIGHTING FOREVER

4 PIN SOP RANDOM-PHASE TRIAC PHOTOCOUPLER

ELM302X Series ELM305X Series

Absolute Maximum Ratings (T_a=25°C)

Parameter		Symbol	Rating	Unit
Input	Forward current	I _F	60	mA
	Reverse voltage	V _R	6	V
	Power dissipation	P _D	100	mW
Output	Off-state Output Terminal Voltage	V _{DRM}	302X 400	V
			305X 600	
	On state RMS current	I _{T(RMS)}	70	mA(RMS)
	Peak Repetitive Surge Current	I _{TSM}	1	A
	Power dissipation	P _D	300	mW
Total power dissipation		P _{TOT}	200	mW
Isolation voltage ^{*1}		V _{iso}	3750	V rms
Operating temperature		T _{opr}	-40~+110	°C
Storage temperature		T _{stg}	-55~+150	°C
Soldering temperature ^{*2}		T _{sol}	260	°C

Notes

*1 AC for 1 minute, R.H.= 40 ~ 60% R.H. In this test, pins 1, 2 & 3 are shorted together, and pins 4, 5 & 6 are shorted together.

*2 For 10 seconds.



LIGHTING FOREVER

4 PIN SOP RANDOM-PHASE TRIAC PHOTOCOUPLER

ELM302X Series
ELM305X Series

Electrical Characteristics (T_a=25°C unless specified otherwise)

Input

Parameter	Symbol	Min.	Typ.*	Max.	Unit	Condition
Forward voltage	V _F	-	1.2	1.5	V	I _F = 10mA
Reverse Leakage current	I _R	-	-	10	μA	V _R = 6V

Output

Parameter	Symbol	Min.	Typ.*	Max.	Unit	Condition
Peak Blocking Current	I _{DRM}	-	-	100	nA	V _{DRM} = Rated V _{DRM} I _F = 0mA
Peak On-state Voltage	V _{TM}	-	-	2.5	V	I _{TM} =100mA peak
Critical Rate of Rise off-state Voltage	ELM302X	-	10	-	V/μs	I _F =0mA, Figure 8
	ELM305X	1000	-	-		

Transfer Characteristics

Parameter	Symbol	Min.	Typ.*	Max.	Unit	Condition
LED Trigger Current	3022 3052	-	-	10	mA	Main terminal Voltage=3V
	3023 3053	-	-	5		
	3024 3054	-	-	3		
Holding Current	I _H	-	3	5	mA	
Turn-on time	T _{on}	-	-	100	μS	V _D =6V, R _L =100ohm, I _F =20mA

* Typical values at T_a = 25°C



LIGHTING FOREVER

4 PIN SOP RANDOM-PHASE TRIAC PHOTOCOUPLER

ELM302X Series ELM305X Series

Typical Performance Curves

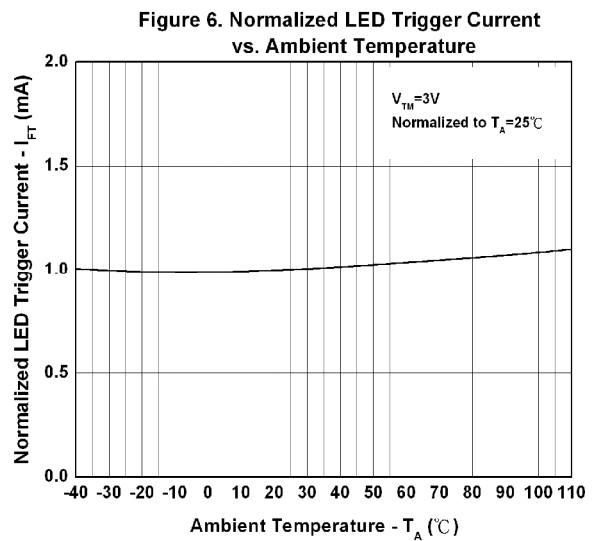
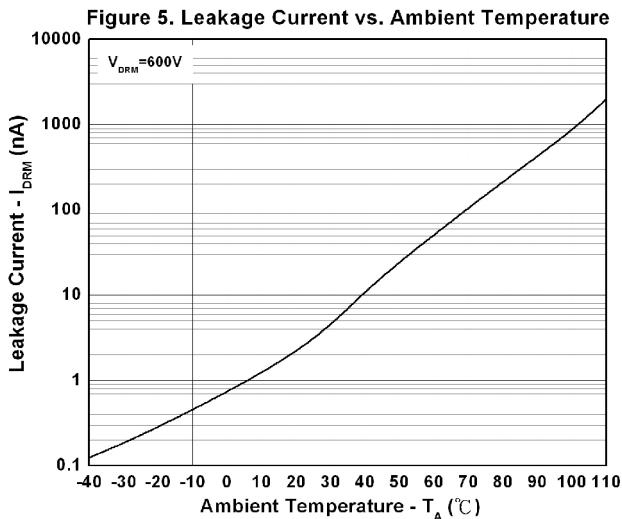
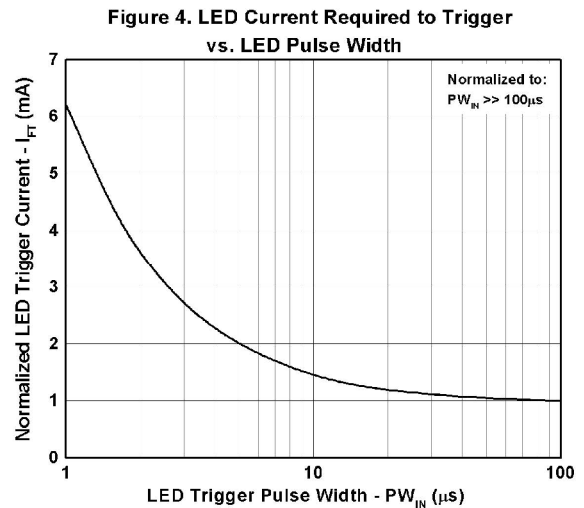
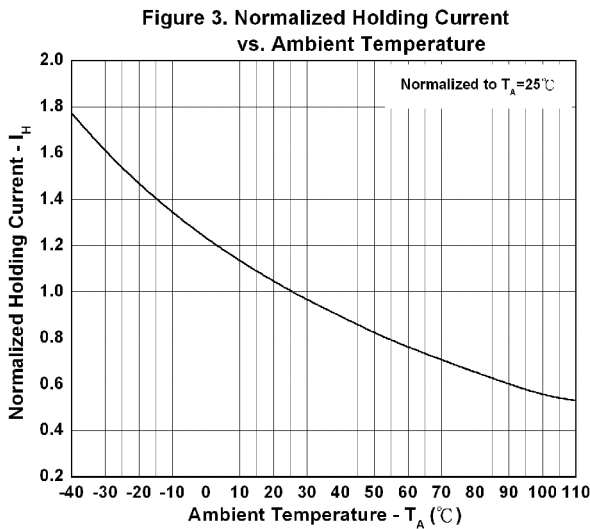
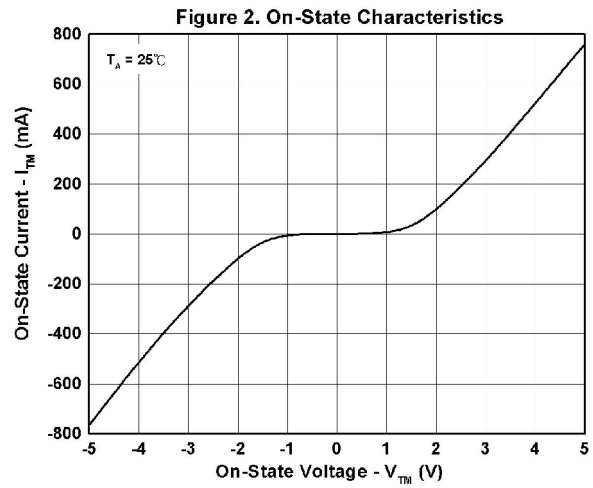
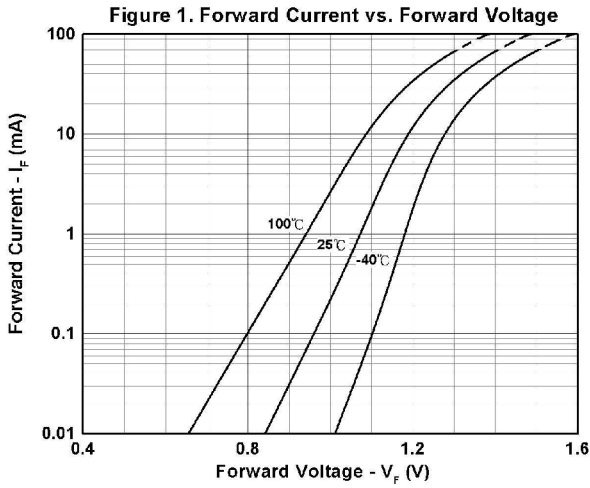

4 PIN SOP RANDOM-PHASE TRIAC PHOTOCOUPLER

ELM302X Series
ELM305X Series

Figure 7. Off-State Output Terminal Voltage vs. Ambient Temperature

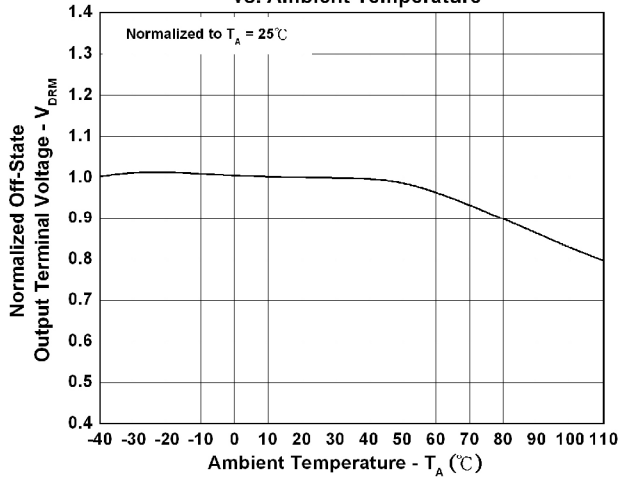
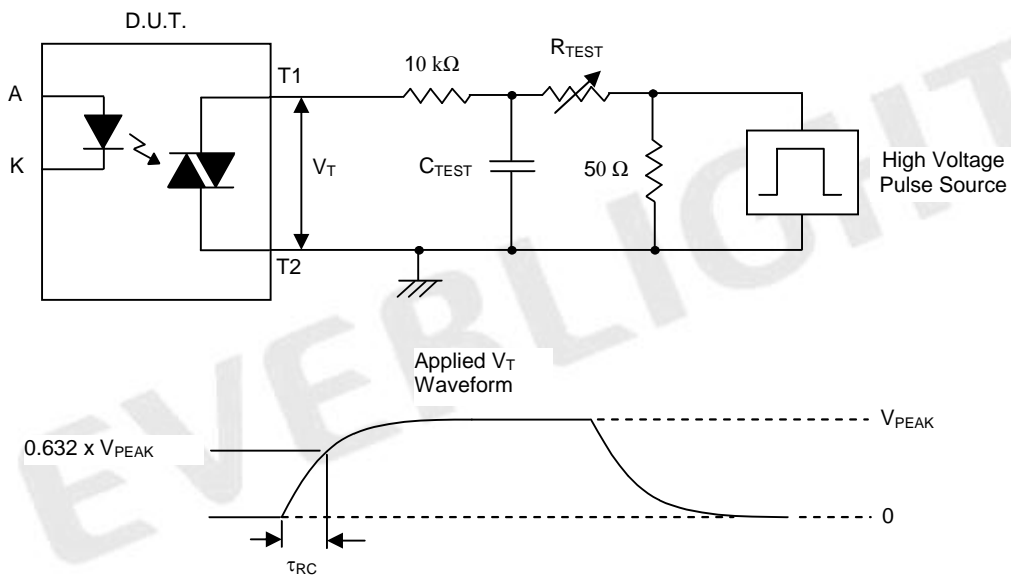

Figure 8. Static dv/dt Test Circuit & Waveform



Measurement Method

The high voltage pulse is set to the required V_{PEAK} value and applied to the D.U.T. output side through the RC circuit above. LED current is not applied. The waveform V_T is monitored using a x100 scope probe. By varying R_{TEST} , the dv/dt (slope) is increased, until the D.U.T. is observed to trigger (waveform collapses). The dv/dt is then decreased until the D.U.T. stops triggering. At this point, τ_{RC} is recorded and the dv/dt calculated.

$$dv/dt = \frac{0.632 \times V_{PEAK}}{\tau_{RC}}$$



LIGHTING FOREVER

4 PIN SOP RANDOM-PHASE TRIAC PHOTOCOUPLER

ELM302X Series ELM305X Series

For example, $V_{PEAK} = 400V$ for EL302X series. The dv/dt value is calculated as follows:

$$dv/dt = \frac{0.63 \times 400}{\tau_{RC}} = \frac{252}{\tau_{RC}}$$

Order Information

Part Number

ELM302X(Z)-V

or

ELM305X(Z)-V

Note

X = Part No. (2 for $I_{FT}=10mA$, 3 for $I_{FT}=5mA$, 4 for $I_{FT}=3mA$)

Z = Tape and reel option (TA, TB or none).

V = VDE safety (optional)

Option	Description	Packing quantity
None	Standard	100 units per tube
None	Standard + VDE safety optional	100 units per tube
(TA)	TA tape & reel option	3000 units per reel
(TB)	TB tape & reel option	3000 units per reel
(TA)-V	TA tape & reel option + VDE safety optional	3000 units per reel
(TB)-V	TB tape & reel option + VDE safety optional	3000 units per reel

**4 PIN SOP RANDOM-PHASE TRIAC
PHOTOCOUPLER**

**ELM302X Series
ELM305X Series**

**Package Drawings
(Dimensions in mm)**

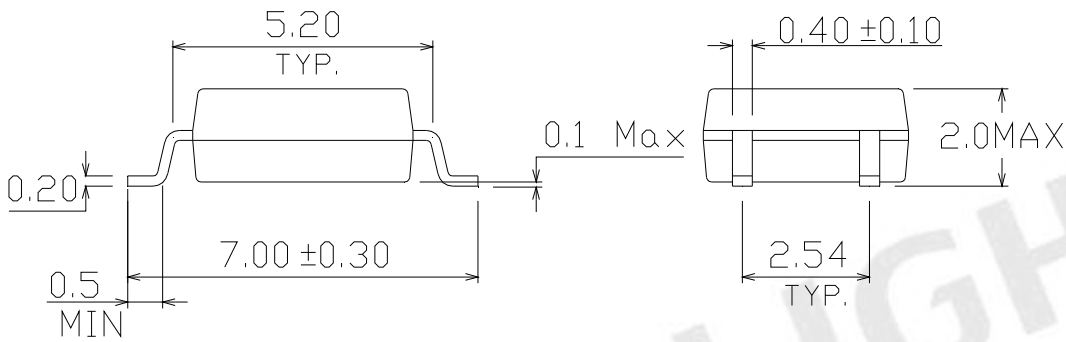
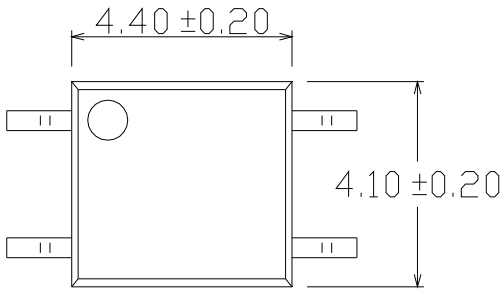

Recommended pad layout for surface mount leadform

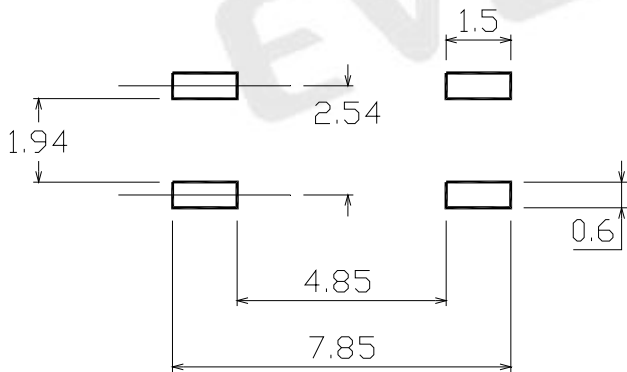



LIGHTING FOREVER

4 PIN SOP RANDOM-PHASE TRIAC PHOTOCOUPLER

ELM302X Series
ELM305X Series

Device Marking



Notes

- EL denotes Everlight
- M3054 denotes Device Number
- Y denotes 1 digit Year code
- WW denotes 2 digit Week code
- V denotes VDE safety option (optional)

EVERLIGHT



LIGHTING FOREVER

4 PIN SOP RANDOM-PHASE TRIAC PHOTOCOUPLER

ELM302X Series
ELM305X Series

Tape & Reel Packing Specifications

Option TA

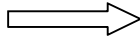
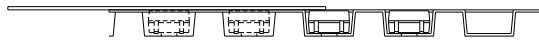
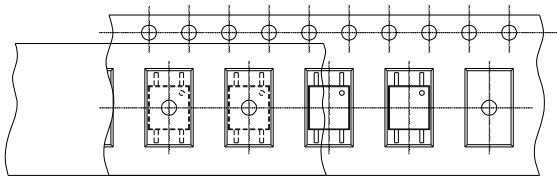

Direction of feed from reel

Option TB

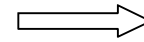
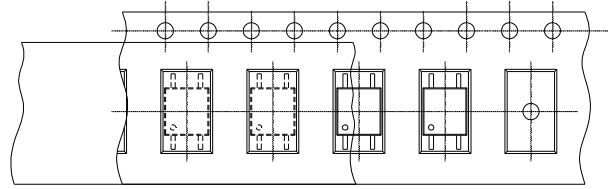

Direction of feed from reel

Tape dimensions

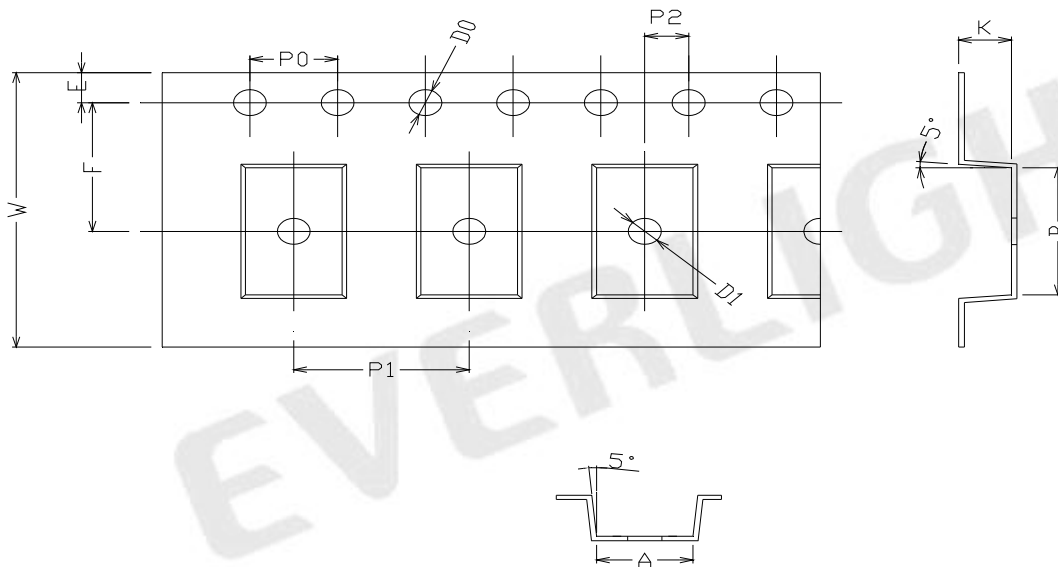

Dimension No.	A	B	Do	D1	E	F
Dimension (mm)	4.4 ± 0.1	7.4 ± 0.1	1.5 + 0.1/-0	1.5 ± 0.1	1.75 ± 0.1	7.5 ± 0.1
Dimension No.	Po	P1	P2	t	W	K
Dimension (mm)	4.0 ± 0.15	8.0 ± 0.1	2.0 ± 0.1	0.25 ± 0.03	16.0 ± 0.2	2.4 ± 0.1



LIGHTING FOREVER

4 PIN SOP RANDOM-PHASE TRIAC PHOTOCOUPLER

ELM302X Series
ELM305X Series

Solder Reflow Temperature Profile

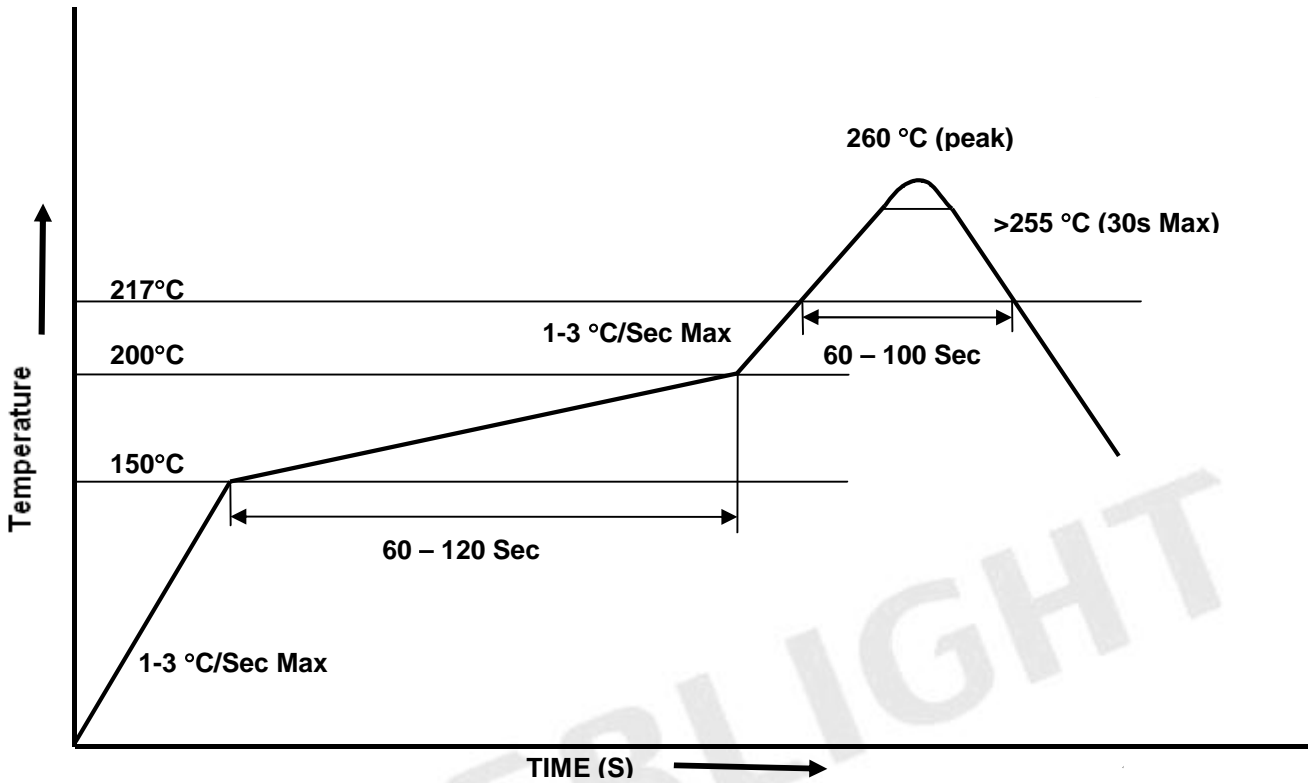



LIGHTING FOREVER

4 PIN SOP RANDOM-PHASE TRIAC PHOTOCOUPLER

ELM302X Series
ELM305X Series

DISCLAIMER

1. Above specification may be changed without notice. EVERLIGHT will reserve authority on material change for above specification.
2. When using this product, please observe the absolute maximum ratings and the instructions for use outlined in these specification sheets. EVERLIGHT assumes no responsibility for any damage resulting from use of the product which does not comply with the absolute maximum ratings and the instructions included in these specification sheets.
3. These specification sheets include materials protected under copyright of EVERLIGHT corporation. Please don't reproduce or cause anyone to reproduce them without EVERLIGHT's consent.

EVERLIGHT