

GC10MPS12-252

1200 V SiC MPST™ Diode



Silicon Carbide Schottky Diode

V_{RRM}	=	1200 V
I_F ($T_C = 135^\circ\text{C}$)	=	25 A
Q_C	=	40 nC

Features

- High Avalanche (UIS) Capability
- Enhanced Surge Current Capability
- Superior Figure of Merit Q_C/I_F
- Low Thermal Resistance
- 175 °C Maximum Operating Temperature
- Temperature Independent Switching Behavior
- Positive Temperature Coefficient of V_F
- Extremely Fast Switching Speeds

Package

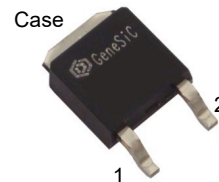

TO-252-2L

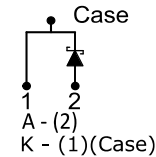

Advantages

- Low Standby Power Losses
- Improved Circuit Efficiency (Lower Overall Cost)
- Low Switching Losses
- Ease of Paralleling without Thermal Runaway
- Smaller Heat Sink Requirements
- Low Reverse Recovery Current
- Low Device Capacitance
- Low Reverse Leakage Current

Applications

- Boost Diode in Power Factor Correction (PFC)
- Switched Mode Power Supply (SMPS)
- Uninterruptible Power Supply (UPS)
- Motor Drives
- Freewheeling / Anti-parallel Diode in Inverters
- Solar Inverters
- LED and HID Lighting
- AC-DC Converters & Auxiliary Power Supplies

Absolute Maximum Ratings (At $T_C = 25^\circ\text{C}$ Unless Otherwise Stated)

Parameter	Symbol	Conditions	Values	Unit
Repetitive Peak Reverse Voltage	V_{RRM}		1200	V
Continuous Forward Current	I_F	$T_C = 25^\circ\text{C}, D = 1$	50	A
		$T_C = 135^\circ\text{C}, D = 1$	25	
		$T_C = 166^\circ\text{C}, D = 1$	10	
Non-Repetitive Peak Forward Surge Current, Half Sine Wave	$I_{F,SM}$	$T_C = 25^\circ\text{C}, t_P = 10\text{ ms}$	82	A
		$T_C = 150^\circ\text{C}, t_P = 10\text{ ms}$	66	
Repetitive Peak Forward Surge Current, Half Sine Wave	$I_{F,RM}$	$T_C = 25^\circ\text{C}, t_P = 10\text{ ms}$	50	A
		$T_C = 150^\circ\text{C}, t_P = 10\text{ ms}$	34	
Non-Repetitive Peak Forward Surge Current	$I_{F,max}$	$T_C = 25^\circ\text{C}, t_P = 10\text{ }\mu\text{s}$	780	A
i^2t Value	$\int i^2 dt$	$T_C = 25^\circ\text{C}, t_P = 10\text{ ms}$	33.7	A^2s
Non-Repetitive Avalanche Energy	E_{AS}	$L = 2.2\text{ mH}, I_{AS} = 10\text{ A}$	110	mJ
Diode Ruggedness	dV/dt	$V_R = 0 \sim 960\text{ V}$	100	V/ns
Power Dissipation	P_{tot}	$T_C = 25^\circ\text{C}$	341	W
Operating and Storage Temperature	T_j, T_{stg}		-55 to 175	$^\circ\text{C}$

GC10MPS12-252

1200 V SiC MPS™ Diode



Electrical Characteristics

Parameter	Symbol	Conditions	Values			Unit
			Min.	Typ.	Max.	
Diode Forward Voltage	V_F	$I_F = 10 \text{ A}, T_j = 25 \text{ }^\circ\text{C}$		1.5	1.8	V
		$I_F = 10 \text{ A}, T_j = 175 \text{ }^\circ\text{C}$		2	2.4	
Reverse Current	I_R	$V_R = 1200 \text{ V}, T_j = 25 \text{ }^\circ\text{C}$		1	10	μA
		$V_R = 1200 \text{ V}, T_j = 175 \text{ }^\circ\text{C}$		3	36	
Total Capacitive Charge	Q_C	$V_R = 400 \text{ V}$		27		nC
		$I_F \leq I_{F,MAX}$ $di_F/dt = 200 \text{ A}/\mu\text{s}$ $T_j = 175 \text{ }^\circ\text{C}$ $V_R = 800 \text{ V}$		40		
Switching Time	t_s	$V_R = 400 \text{ V}$		< 10		ns
		$V_R = 800 \text{ V}$				
Total Capacitance	C	$V_R = 1 \text{ V}, f = 1 \text{ MHz}, T_j = 25 \text{ }^\circ\text{C}$		660		pF
		$V_R = 800 \text{ V}, f = 1 \text{ MHz}, T_j = 25 \text{ }^\circ\text{C}$		50		

Thermal / Mechanical Characteristics

Thermal Resistance, Junction - Case	R_{thJC}		0.4	$^\circ\text{C}/\text{W}$
Weight	W_T		0.3	g

GC10MPS12-252

1200 V SiC MPS™ Diode

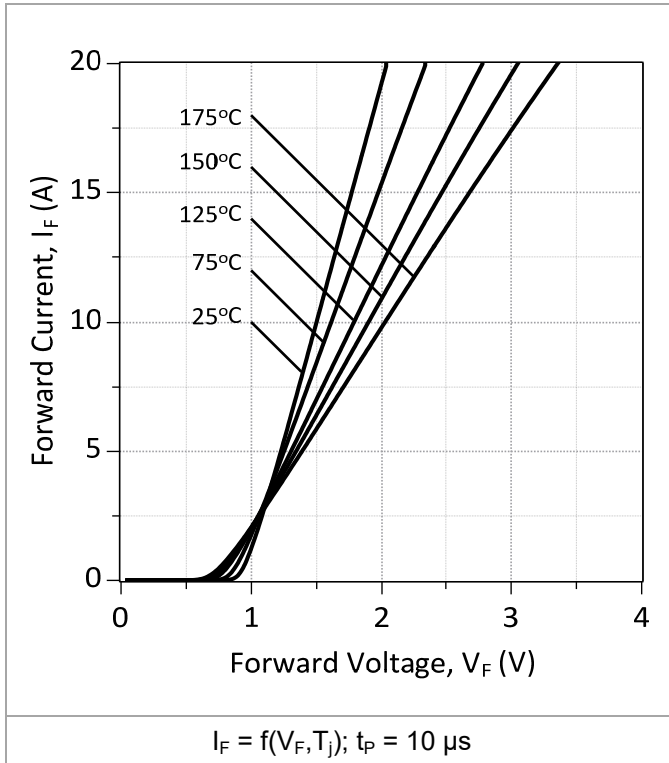

Figure 1: Typical Forward Characteristics

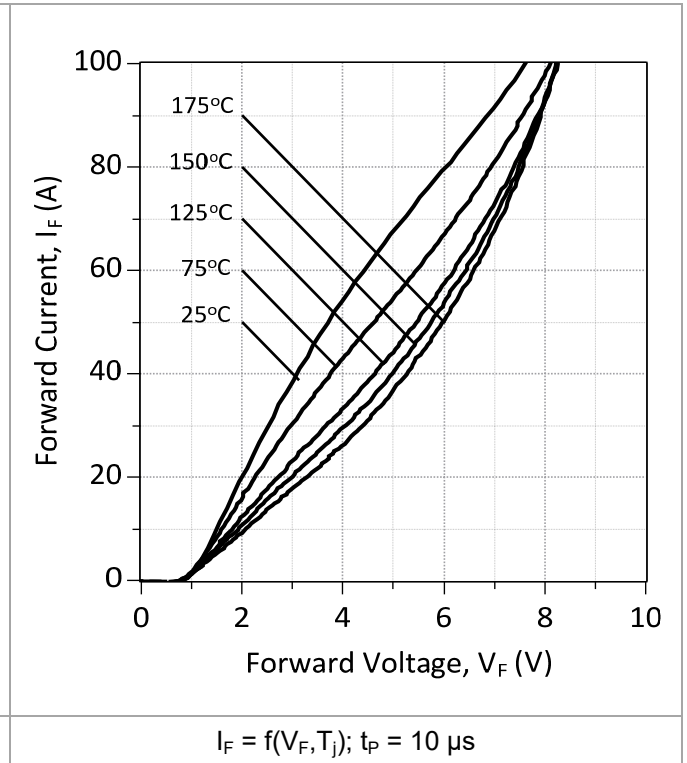

Figure 2: Typical High Current Forward Characteristics

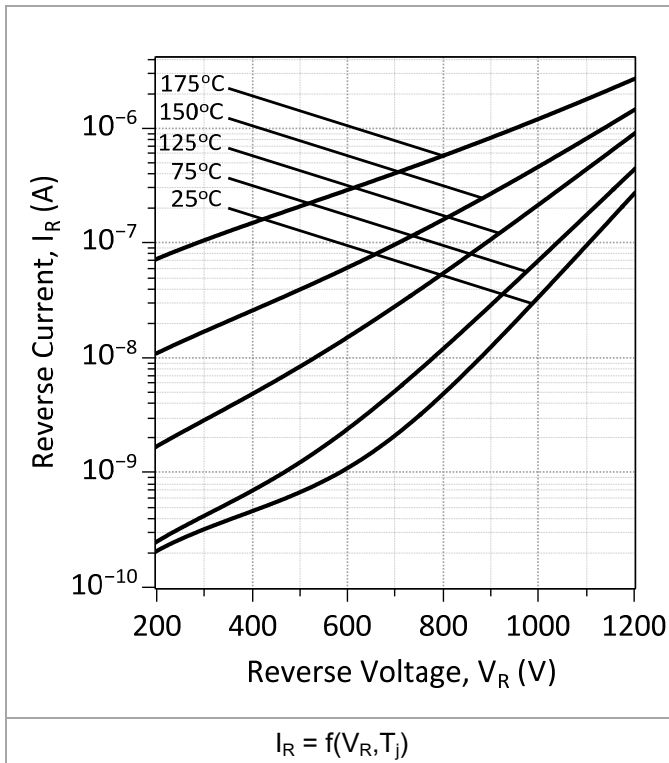

Figure 3: Typical Reverse Characteristics

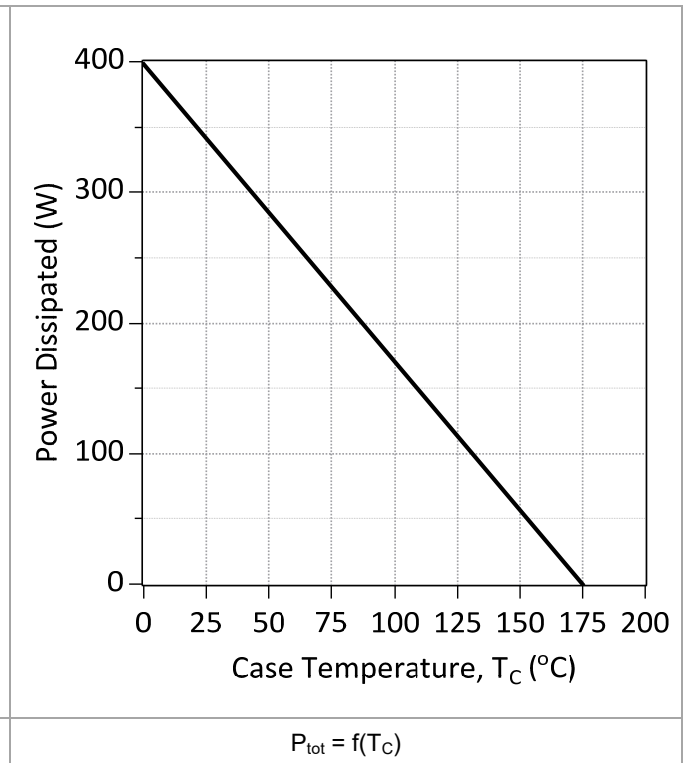

Figure 4: Power Derating Curve

GC10MPS12-252

1200 V SiC MPS™ Diode

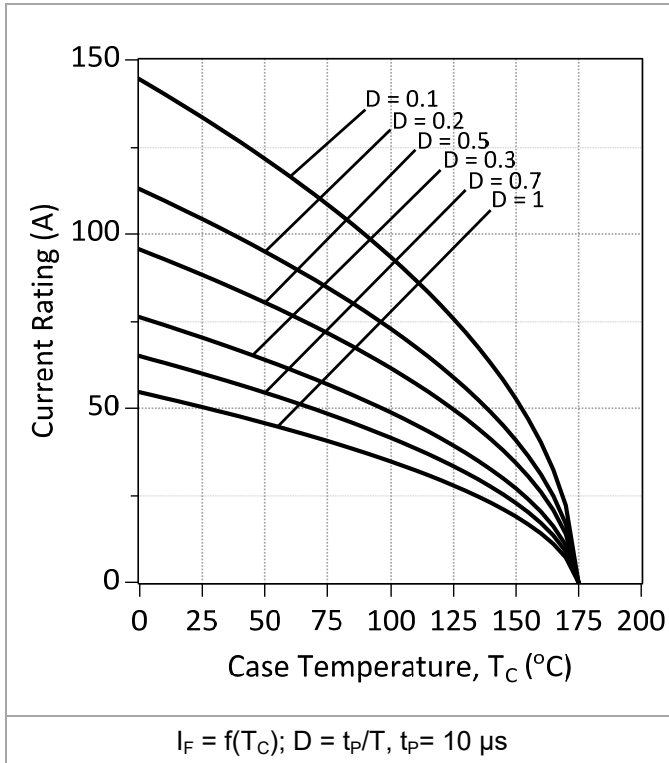

Figure 5: Current Derating Curves

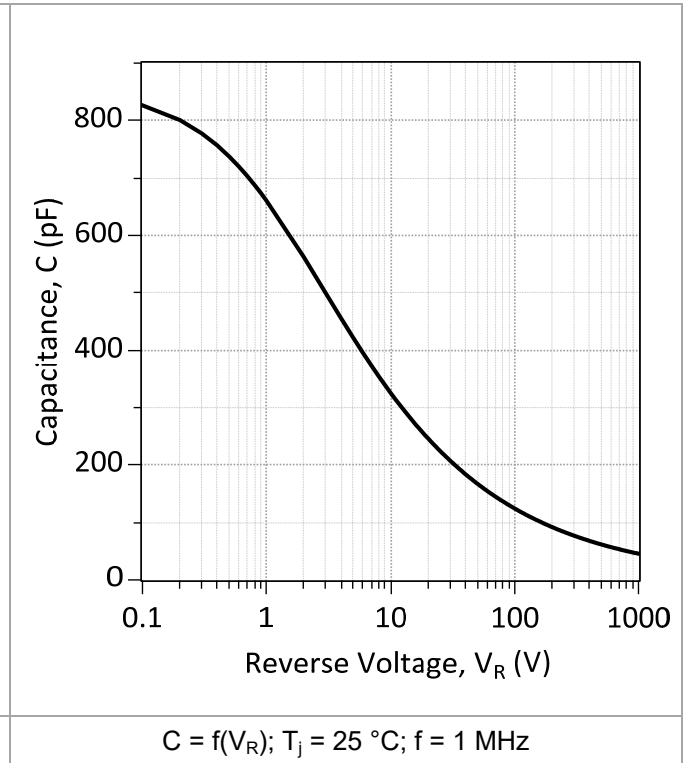

Figure 6: Typical Junction Capacitance vs Reverse Voltage Characteristics

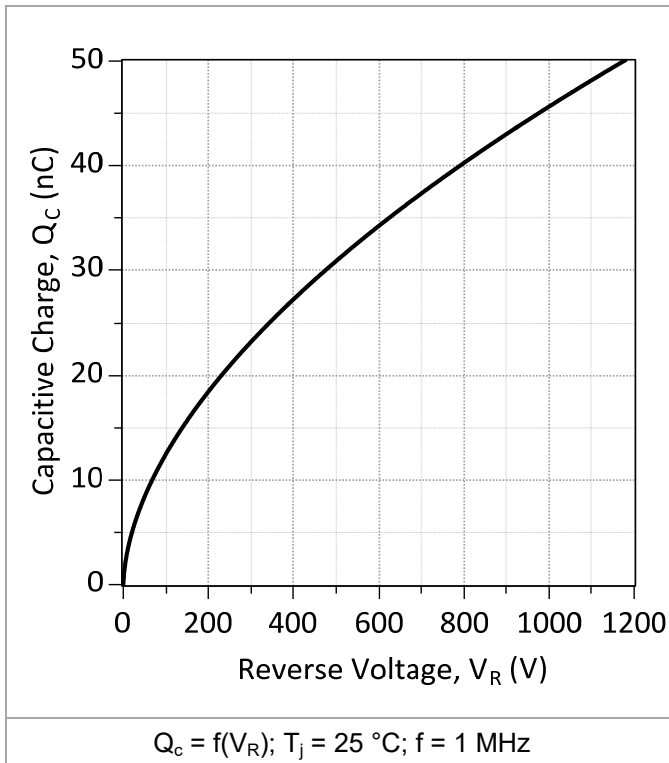

Figure 7: Typical Capacitive Charge vs Reverse Voltage Characteristics

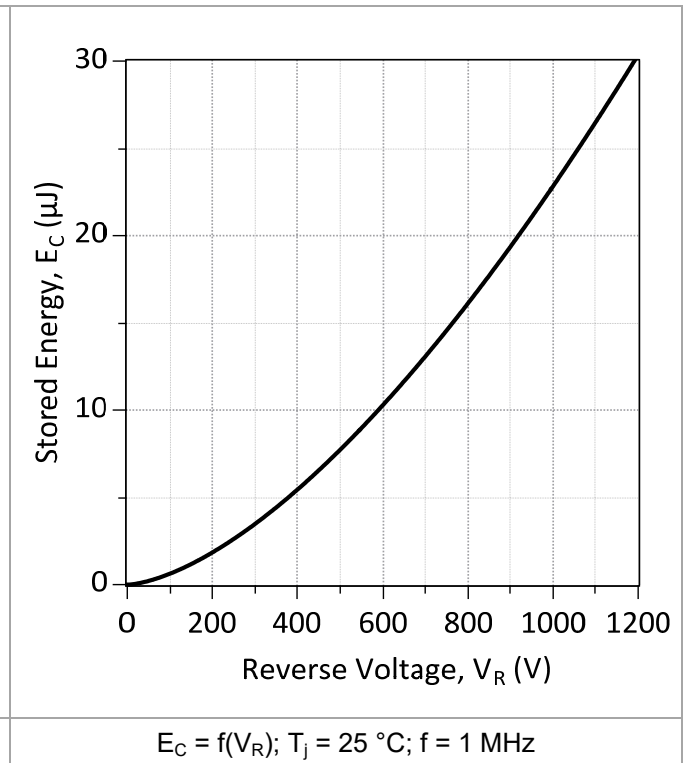

Figure 8: Typical Capacitive Energy vs Reverse Voltage Characteristics

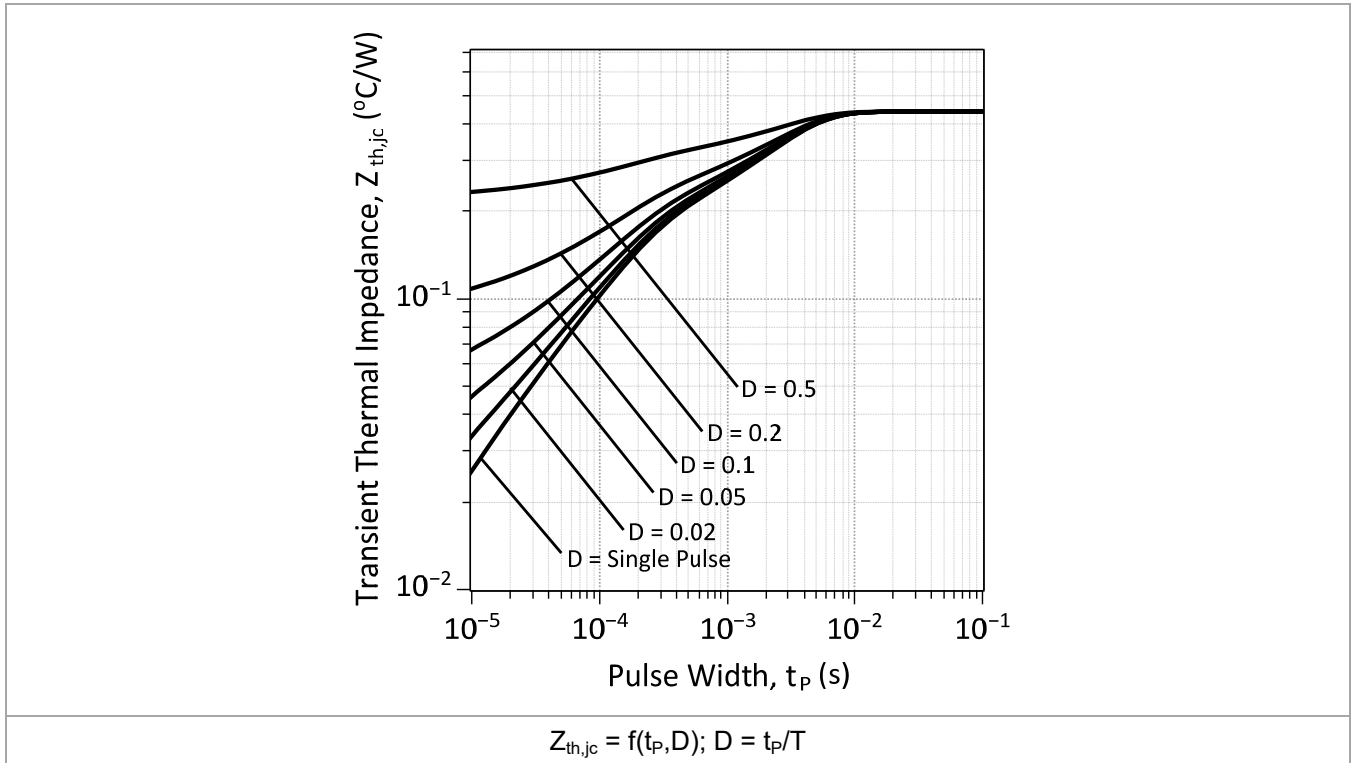

Figure 9: Transient Thermal Impedance

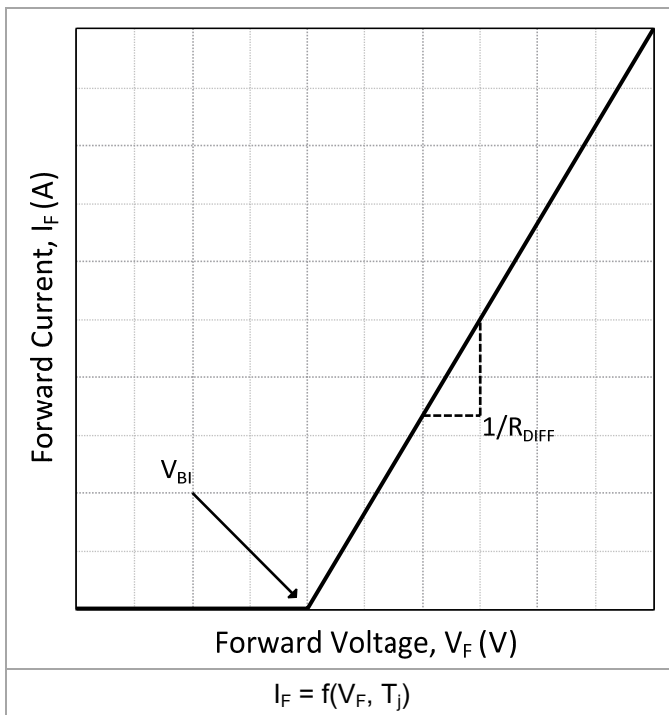

Figure 10: Forward Curve Model

$$I_F = (V_F - V_{Bi})/R_{DIFF} \text{ (A)}$$

Built-In Voltage (V_{Bi}):

$$V_{Bi}(T_j) = m \cdot T_j + n \text{ (V)}$$

$$m = -1.55e-03, n = 1.01$$

Differential Resistance (R_{DIFF}):

$$R_{DIFF}(T_j) = a \cdot T_j^2 + b \cdot T_j + c \text{ (}\Omega\text{);}$$

$$a = 1.26e-06, b = 2.11e-04, c = 0.0447$$

GC10MPS12-252

1200 V SiC MPS™ Diode



Package Dimensions

TO-252-2L

Package Outline

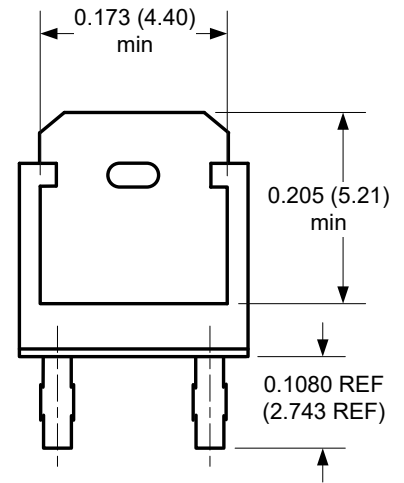
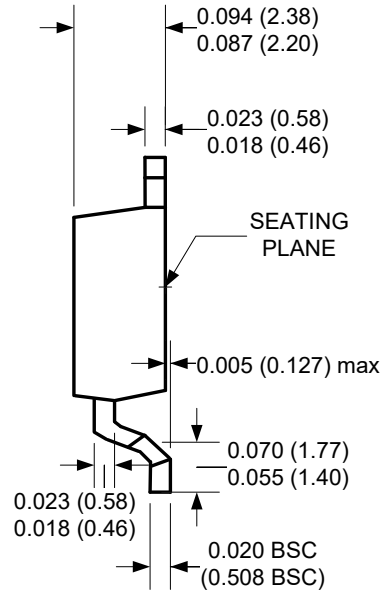
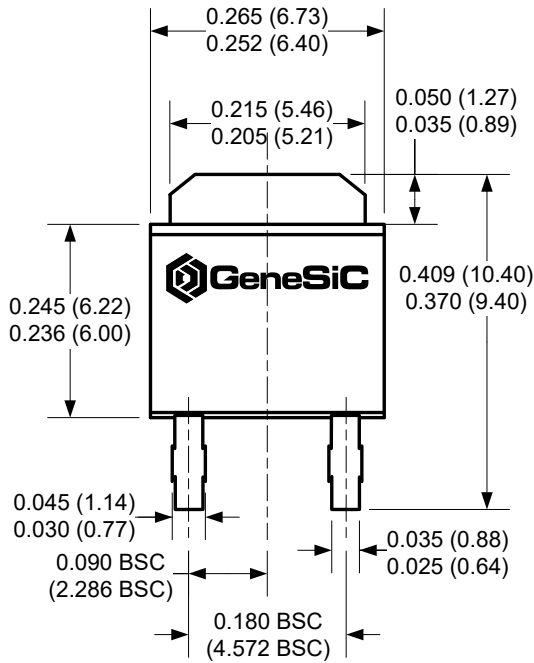

Recommended Solder Pad Layout

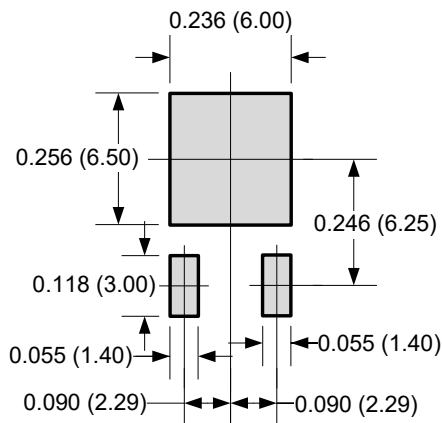

NOTE

1. CONTROLLED DIMENSION IS INCH. DIMENSION IN BRACKET IS MILLIMETER.
2. DIMENSIONS DO NOT INCLUDE END FLASH, MOLD FLASH, MATERIAL PROTRUSIONS

GC10MPS12-252

1200 V SiC MPS™ Diode



RoHS Compliance

The levels of RoHS restricted materials in this product are below the maximum concentration values (also referred to as the threshold limits) permitted for such substances, or are used in an exempted application, in accordance with EU Directive 2011/65/EC (RoHS2), as implemented January 2, 2013. RoHS Declarations for this product can be obtained from your GeneSiC representative.

REACH Compliance

REACH substances of high concern (SVHCs) information is available for this product. Since the European Chemical Agency (ECHA) has published notice of their intent to frequently revise the SVHC listing for the foreseeable future, please contact a GeneSiC representative to insure you get the most up-to-date REACH SVHC Declaration. REACH banned substance information (REACH Article 67) is also available upon request.

This product has not been designed or tested for use in, and is not intended for use in, applications implanted into the human body nor in applications in which failure of the product could lead to death, personal injury or property damage, including but not limited to equipment used in the operation of nuclear facilities, life-support machines, cardiac defibrillators or similar emergency medical equipment, aircraft navigation or communication or control systems, or air traffic control systems.

GeneSiC disclaims all and any warranty and liability arising out of use or application of any product. No license, express or implied to any intellectual property rights is granted by this document.

Related Links

- Soldering Document: <http://www.genesicsemi.com/quality/quality-manual/>
- Tin-whisker Report: <http://www.genesicsemi.com/quality/compliance/>
- Reliability Report: <http://www.genesicsemi.com/quality/reliability/>