

CSTCR6M00G55Z-R0

In Production Recommended RoHS REACH

Appearance & Shape

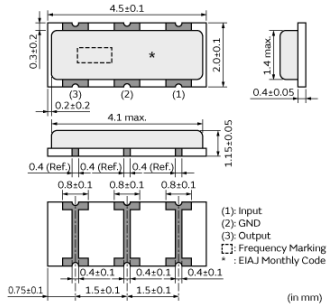

Features

MURATA's package technology expertise has enabled the development of the Chip CERALOCK(R) with built-in load capacitors. High-density mounting can be realized because of the small package and the elimination of the need for an external load capacitor.

Features

1. Oscillation circuits do not require external load capacitors.
2. Available in a wide frequency range.
3. Extremely small and have a low profile.
4. No adjustment is necessary for oscillation circuits.

Applications

Other Usage	Consumer/Industrial
-------------	---------------------

Packaging Information

Packaging	Specifications	Minimum Order Quantity
R0	180mm Embossed Tape	3000

Attention

1. This datasheet is downloaded from the website of Murata Manufacturing Co., Ltd. Therefore, its specifications are subject to change or our products in it may be discontinued without advance notice. Please check with our sales representatives or product engineers before ordering.
2. This datasheet has only typical specifications because there is no space for detailed specifications. Therefore, please review our product specifications or consult the approval sheet for product specifications before ordering.

CSTCR6M00G55Z-R0

Specifications

Shape	SMD
Frequency	6.000MHz
Frequency Tolerance	±0.50%
Operating Temperature Range	-40°C to 125°C
Frequency Shift by Temperature	±0.30%
Frequency Aging	±0.10%
Wash	Not available
Resonant Impedance	50Ω
Built-in Load Capacitance	39pF

Attention

- 1.This datasheet is downloaded from the website of Murata Manufacturing Co., Ltd. Therefore, it's specifications are subject to change or our products in it may be discontinued without advance notice. Please check with our sales representatives or product engineers before ordering.
- 2.This datasheet has only typical specifications because there is no space for detailed specifications. Therefore, please review our product specifications or consult the approval sheet for product specifications before ordering.