



EVQ4313-R-01A

45V, 3A, Low-I_Q, Synchronous Step-Down Converter with Frequency Spread Spectrum Evaluation Board, AEC-Q100 Qualified

DESCRIPTION

The EVQ4313-R-01A evaluation board is designed to demonstrate the capabilities of the MPQ4313, a synchronous, step-down switching regulator with a configurable frequency and an integrated, internal high-side MOSFET (HS-FET) and low-side MOSFET (LS-FET). It provides up to 3A of highly efficient output current (I_{OUT}), with current mode control for fast loop response.

The wide 3.3V to 45V input voltage (V_{IN}) range accommodates a variety of step-down applications in automotive input environments. A 1.7μA quiescent current (I_Q) in shutdown mode allows the device to be used in battery-powered applications. High power conversion

efficiency across a wide load range is achieved by scaling down the switching frequency (f_{SW}) under light-load conditions to reduce switching and gate driver losses.

Frequency foldback helps prevent inductor current (I_L) runaway during start-up. Thermal shutdown provides reliable, fault-tolerant operation. High-duty cycle and low-dropout mode are provided for automotive cold crank conditions.

The EVQ4313-R-01A is fully assembled and tested. The MPQ4313 is available in a QFN-20 (4mmx4mm) package with wettable flank, and is AEC-Q100 Grade 1 qualified.

PERFORMANCE SUMMARY

Specifications are at T_A = 25°C, unless otherwise noted.

Parameter	Condition	Value
Input voltage (V _{IN}) range		3.3V to 45V
Output voltage (V _{OUT})	V _{IN} = 3.3V to 45V, I _{OUT} = 0A to 3A	3.3V
Maximum output current (I _{OUT})	V _{IN} = 3.3V to 45V	3A
Typical efficiency	V _{IN} = 12V, V _{OUT} = 3.3V, I _{OUT} = 3A	94.2%
Switching frequency (f _{SW})		410kHz

EVQ4313-R-01A EVALUATION BOARD

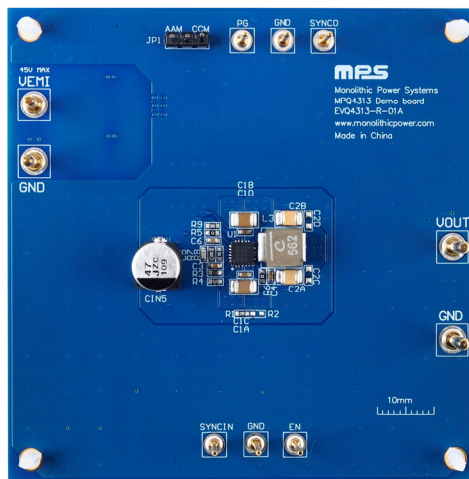

LxWxH (8.3cmx8.3cmx1.3cm)

Board Number	MPS IC Number
EVQ4313-R-01A	MPQ4313GRE-AEC1

QUICK START GUIDE

1. Preset the power supply (V_{IN}) between 3.3V and 45V, then turn off the power supply. Electronic loads represent a negative impedance to the regulator, setting a current too high can trigger hiccup mode.
2. If longer cables (>0.5m total) are used between the source and the evaluation board, install a damping capacitor at the input terminals, especially when $V_{IN} \geq 24V$.
3. Connect the power supply terminals to:
 - a. Positive (+): VEMI
 - b. Negative (-): GND
4. Connect the load terminals to:
 - a. Positive (+): VOUT
 - b. Negative (-): GND
5. After making the connections, turn on the power supply. The board should automatically start up.
6. To use the enable function, apply a digital input to the EN pin. Drive EN above 1V to turn on the regulator; drive EN below 0.85V to turn off the regulator.
7. The MPQ4313's switching frequency (f_{SW}) can be configured by R3, the FREQ pin's resistor (R_{FREQ}). R3 can be estimated based on the relationship between f_{SW} and R_{FREQ} (see Figure 1).

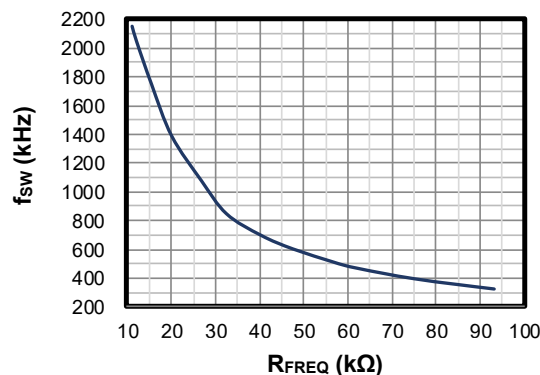

Figure 1: f_{SW} vs. R_{FREQ}

8. To use the sync function, apply a 350kHz to 1000kHz external clock to the SYNCIN pin to synchronize the internal clock's rising edge.
9. The output voltage (V_{OUT}) is set by the external resistor divider. If $R7 = 100k\Omega$, then $R8$ can be calculated using Equation (1):

$$R8 = \frac{R7}{\frac{V_{OUT}}{0.815V} - 1} \quad (1)$$

Table 1 shows the recommended $R7$ and $R8$ values for common output voltages.

Table 1: Resistor Selection for Output Voltages

V_{OUT} (V)	$R7$ (k Ω)	$R8$ (k Ω)
3.3	100 (1%)	32.4 (1%)
5	100 (1%)	19.1 (1%)

Figure 2 shows the measurement equipment set-up.

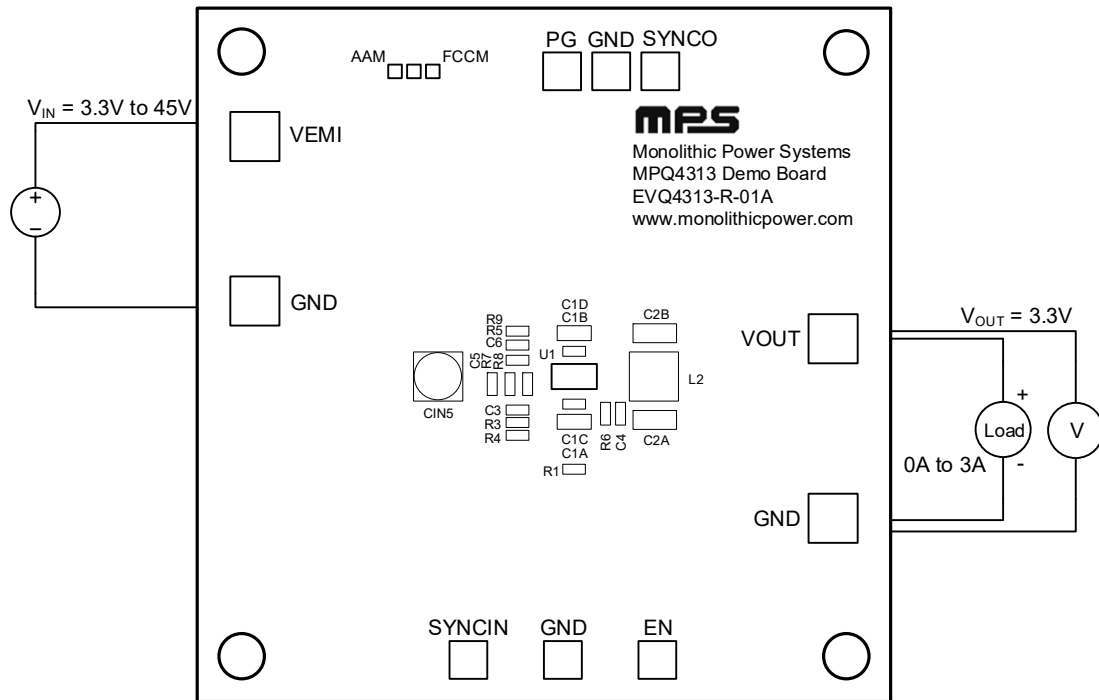

Figure 2: Measurement Equipment Set-Up

EVALUATION BOARD SCHEMATIC

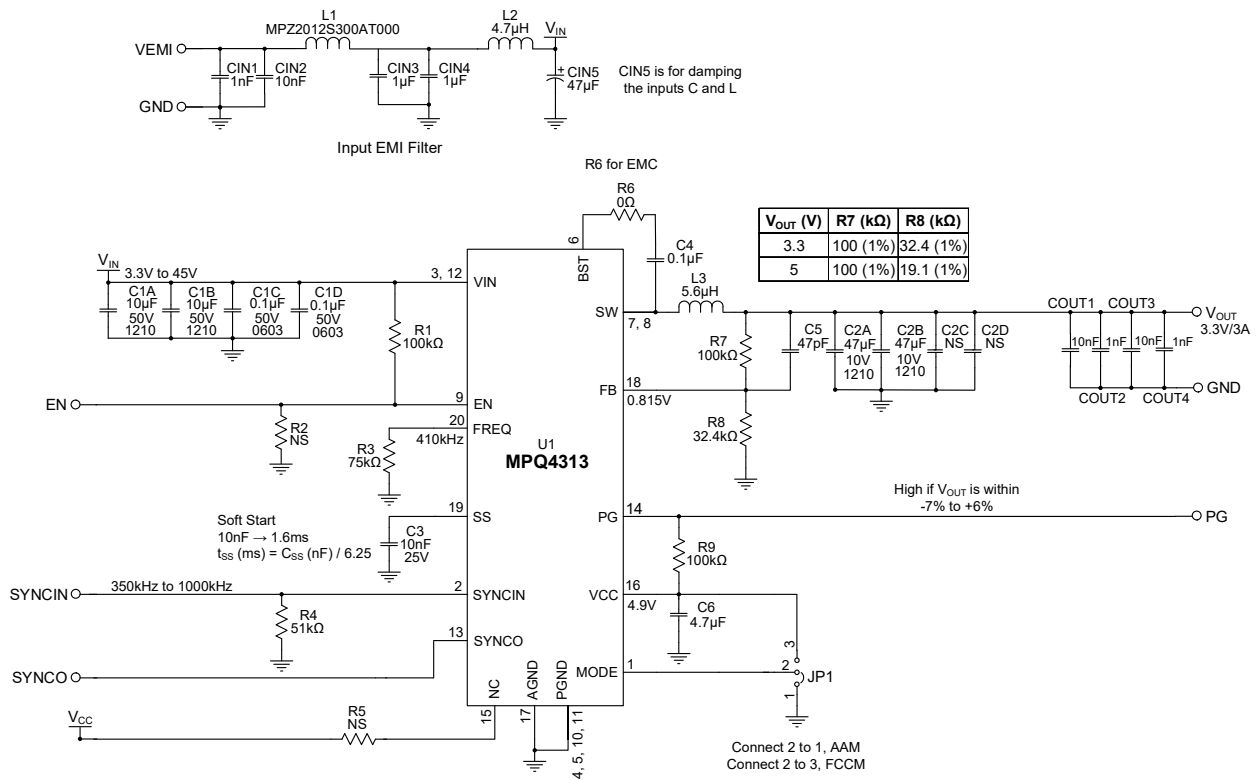
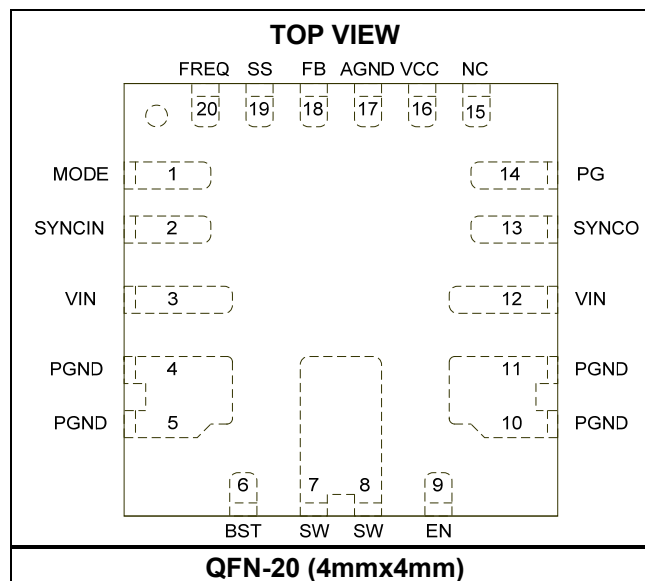

Figure 3: Evaluation Board Schematic

PACKAGE REFERENCE



EVQ4313-R-01A BILL OF MATERIALS

Qty	Ref	Value	Description	Package	Manufacturer	Manufacturer PN
3	CIN1, COUT2, COUT4	1nF	Ceramic capacitor, 50V, X7R	0603	Murata	GRM216R71H102KA01
3	CIN2, COUT1, COUT3	10nF	Ceramic capacitor, 50V, X7R	0603	Murata	GRM188R71H103KA01D
2	CIN3, CIN4	1 μ F	Ceramic capacitor, 50V, X7R	1206	TDK	C3216X7R1H105K
1	CIN5	47 μ F	Aluminum capacitor, 63V	SMD	Panasonic	EEHZA1J470P
2	C1A, C1B	10 μ F	Ceramic capacitor, 50V, X7R	1210	Murata	GRM32ER71H106KA12L
2	C1C, C1D	0.1 μ F	Ceramic capacitor, 50V, X7R	0603	Murata	GCJ188R71H104KA12D
2	C2A, C2B	47 μ F	Ceramic capacitor, 10V, X5R	1210	Murata	GRM32ER61A476KE20L
1	C3	10nF	Ceramic capacitor, 25V, X7R	0603	Murata	GRM188R71E103KA01D
1	C4	0.1 μ F	Ceramic capacitor, 50V, X7R	0603	Murata	GRM188R71H104KA93D
1	C5	47pF	Ceramic capacitor, 50V, C0G	0603	TDK	C1608C0G1H470J
1	C6	4.7 μ F	Ceramic capacitor, 10V, X5R	0603	Murata	GRM188R61A475KE15D
1	L1	30m Ω	Magnetic bead, 6A	0805	TDK	MPZ2012S300AT000
1	L2	4.7 μ H	Inductor, 31.5m Ω , 6A	SMD	Cyntec	VCMT063T-4R7MN5T
1	L3	5.6 μ H	Inductor, 14.5m Ω , 9.9A	SMD	Coilcraft	XAL6060-562MEC
3	R1, R7, R9	100k Ω	Film resistor, 1%	0603	Yageo	RC0603FR-07100KL
1	R3	75k Ω	Film resistor, 1%	0603	Yageo	RC0603FR-0775KL
1	R4	51k Ω	Film resistor, 1%	0603	Yageo	RC0603FR-0751KL
1	R6	0 Ω	Film resistor, 1%	0603	Yageo	RC0603FR-070RL
1	R8	32.4k Ω	Film resistor, 1%	0603	Yageo	RC0603FR-0732K4L
4	C2C, C2D, R2, R5	NS				
1	JP1	2.54mm	Test pin, 3-pin	DIP	Any	
4	VEMI, GND, VOUT, GND	2mm	Golden pin	DIP	Custom ⁽¹⁾	
7	SYNCIN, ICS, PG, SYNCO, EN, GND, GND	1mm	Golden pin	DIP	Custom ⁽¹⁾	
1	U1	MPQ4313	45V, 3A, step-down converter, AEC-Q100	QFN-20 (4mmx4mm)	MPS	MPQ4313GRE-AEC1

Note:

1) Contact an MPS FAE for more information regarding custom pins.

EVB TEST RESULTS

Performance curves and waveforms are tested on the evaluation board, $V_{IN} = 12V$, $V_{OUT} = 3.3V$, $C_{OUT} = 2 \times 47\mu F$, $L = 5.6\mu H$, $f_{sw} = 410kHz$, $T_A = 25^\circ C$, unless otherwise noted.

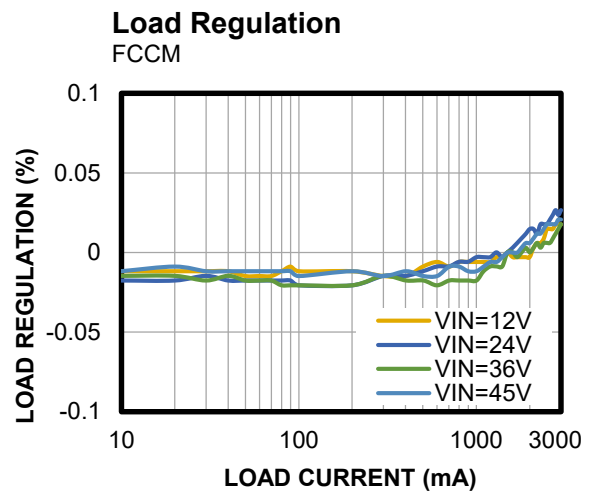
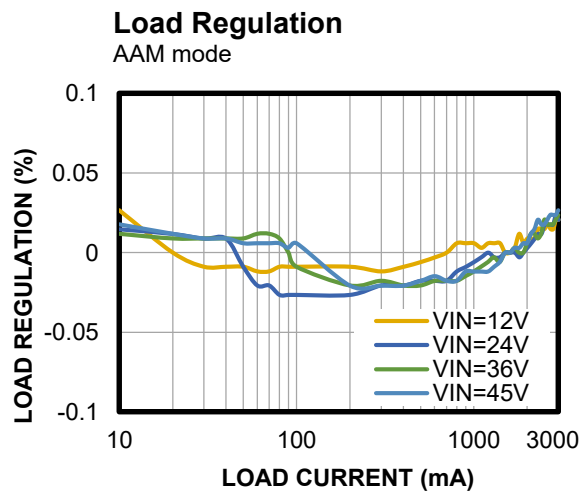
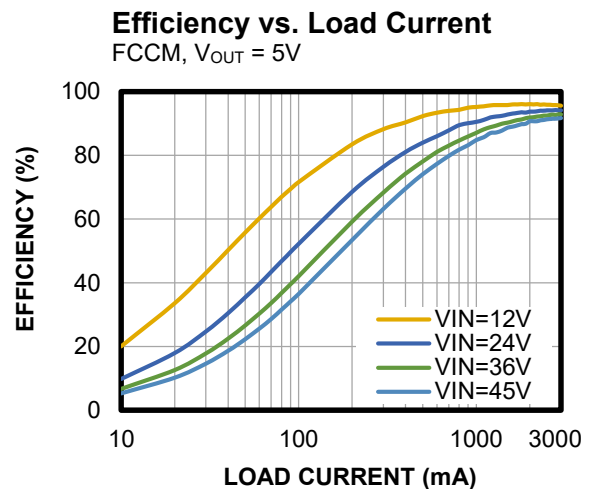
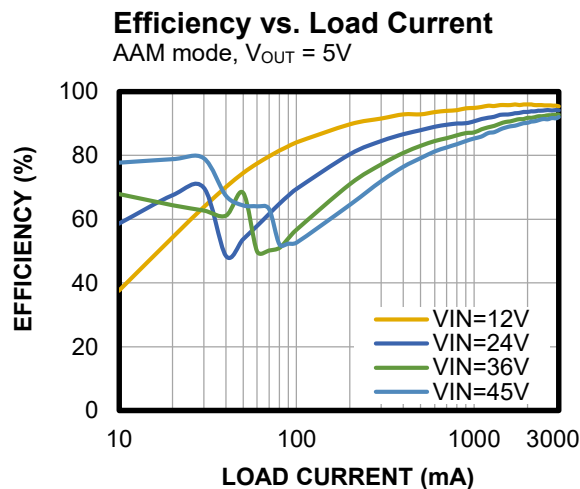
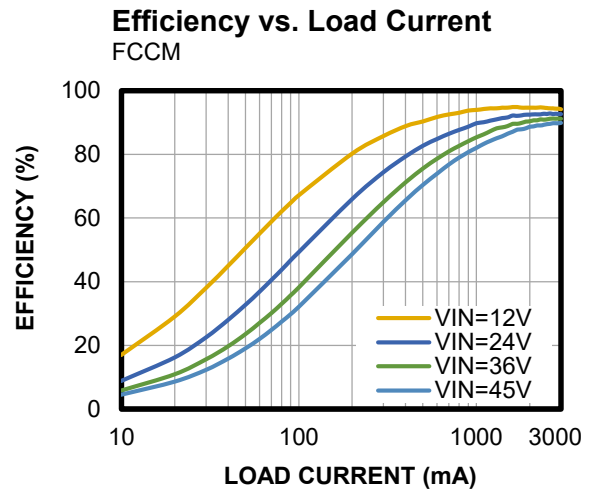
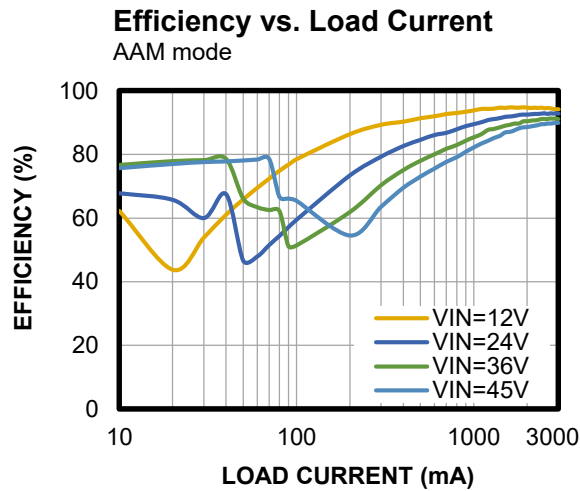

EVB TEST RESULTS (continued)

Performance curves and waveforms are tested on the evaluation board, $V_{IN} = 12V$, $V_{OUT} = 3.3V$, $C_{OUT} = 2 \times 47\mu F$, $L = 5.6\mu H$, $f_{SW} = 410kHz$, $T_A = 25^\circ C$, unless otherwise noted.

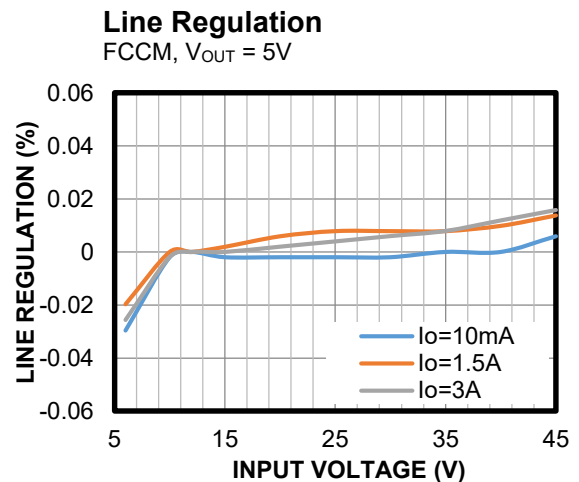
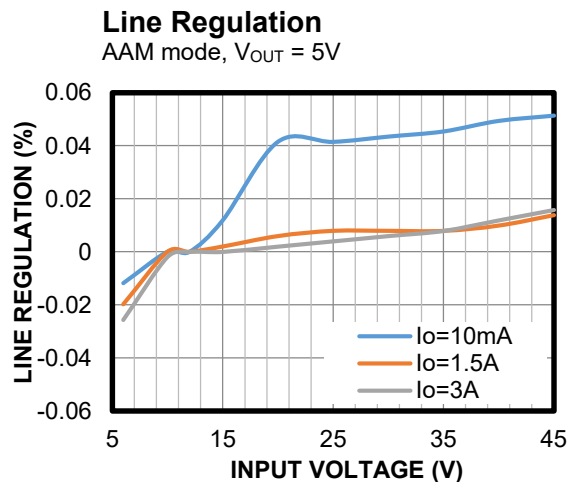
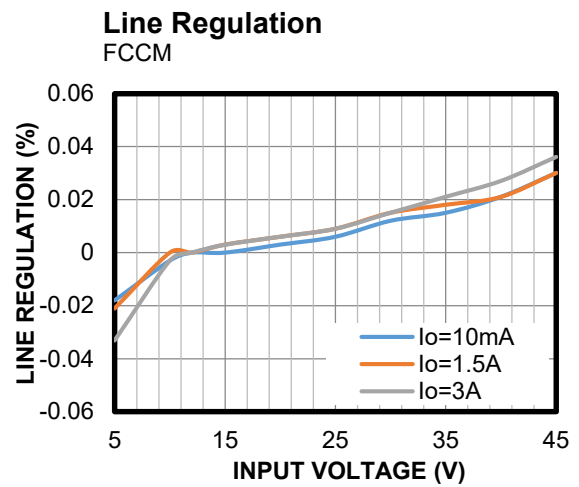
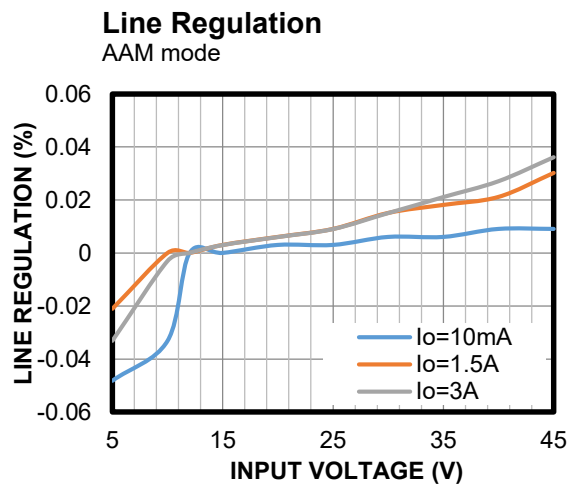
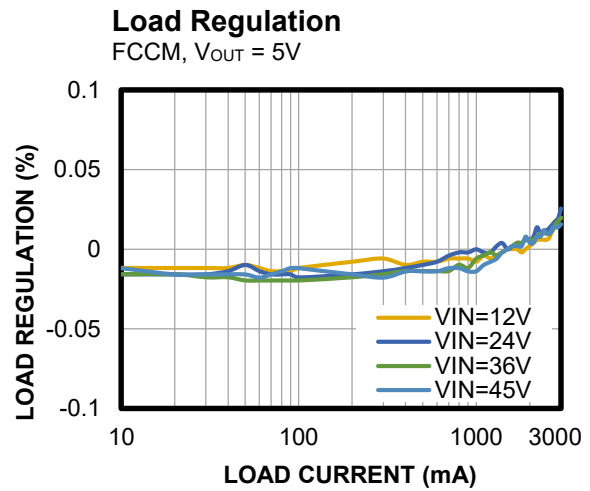
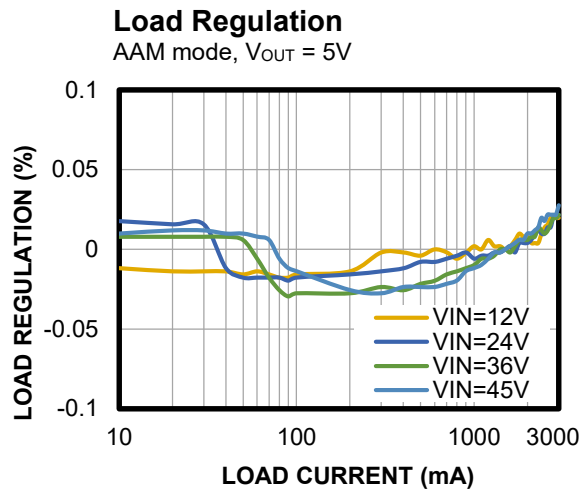

EVB TEST RESULTS *(continued)*

Performance curves and waveforms are tested on the evaluation board, $V_{IN} = 12V$, $V_{OUT} = 3.3V$, $C_{OUT} = 2 \times 47\mu F$, $L = 5.6\mu H$, $f_{SW} = 410kHz$, $T_A = 25^\circ C$, unless otherwise noted.

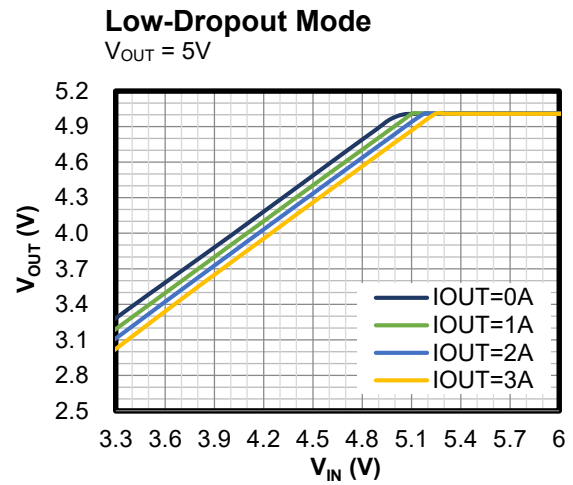
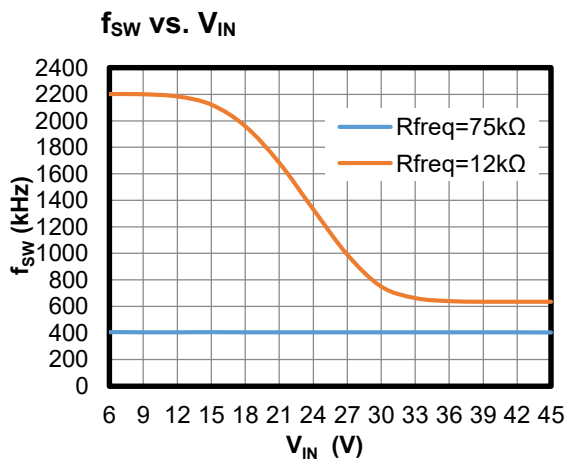
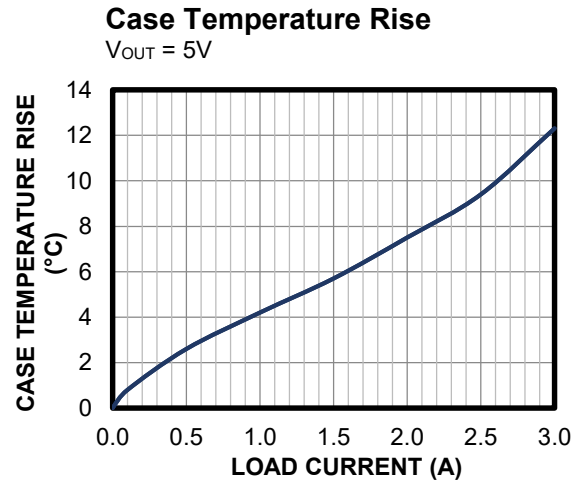
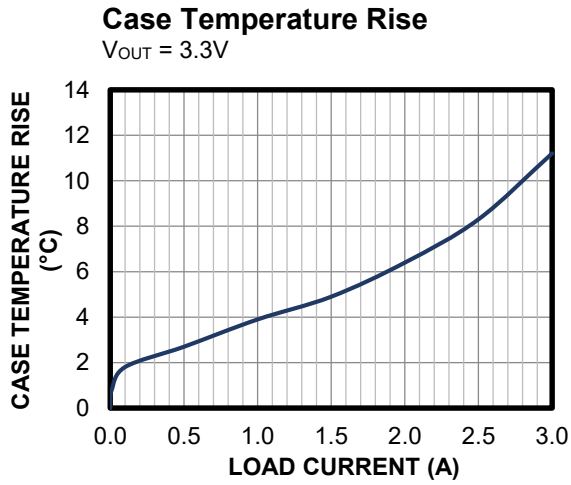

EVB TEST RESULTS (continued)

Performance curves and waveforms are tested on the evaluation board, $V_{IN} = 12V$, $V_{OUT} = 3.3V$, $C_{OUT} = 2 \times 47\mu F$, $L = 5.6\mu H$, $f_{SW} = 410kHz$, $T_A = 25^\circ C$, unless otherwise noted.

CISPR25 Class 5 Peak Conducted Emissions

150kHz to 108MHz

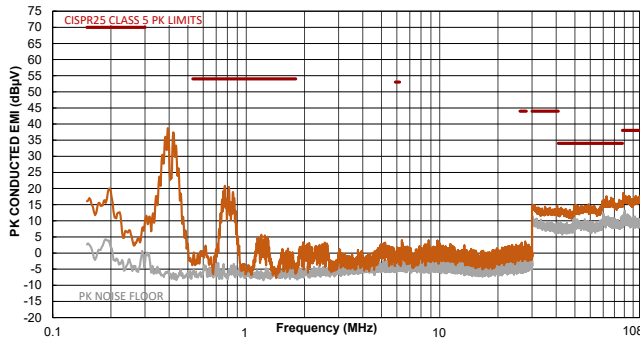

CISPR25 Class 5 Average Conducted Emissions

150kHz to 108MHz

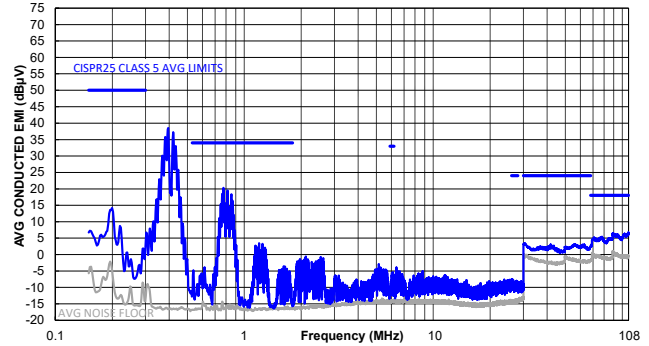

CISPR25 Class 5 Peak Radiated Emissions

150kHz to 30MHz

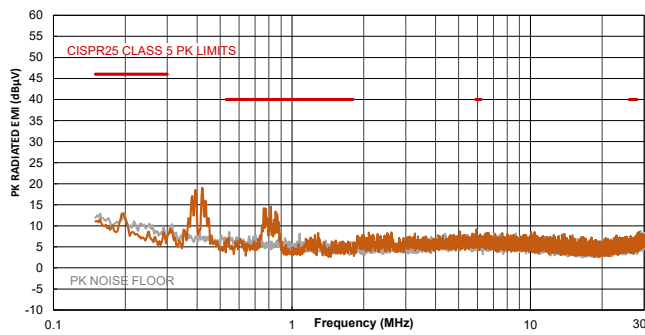

CISPR25 Class 5 Average Radiated Emissions

150kHz to 30MHz

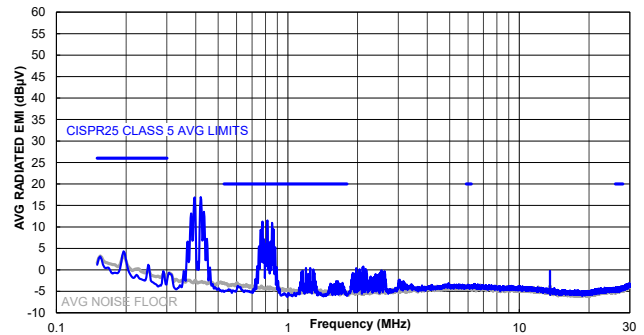

CISPR25 Class 5 Peak Radiated Emissions

Horizontal, 30MHz to 1GHz

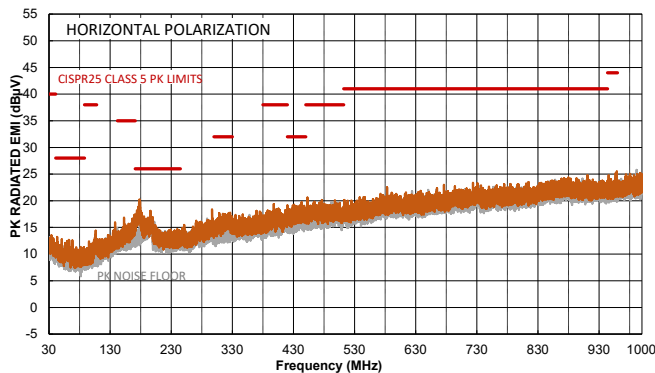

CISPR25 Class 5 Average Radiated Emissions

Horizontal, 30MHz to 1GHz

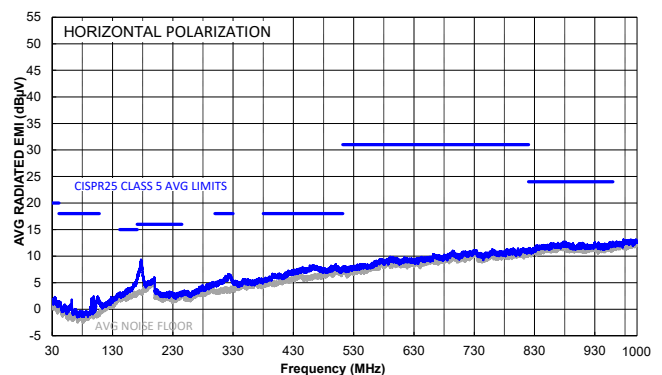

EVB TEST RESULTS *(continued)*

Performance curves and waveforms are tested on the evaluation board, $V_{IN} = 12V$, $V_{OUT} = 3.3V$, $C_{OUT} = 2 \times 47\mu F$, $L = 5.6\mu H$, $f_{SW} = 410kHz$, $T_A = 25^\circ C$, unless otherwise noted.

CISPR25 Class 5 Peak Radiated Emissions

Vertical, 30MHz to 1GHz

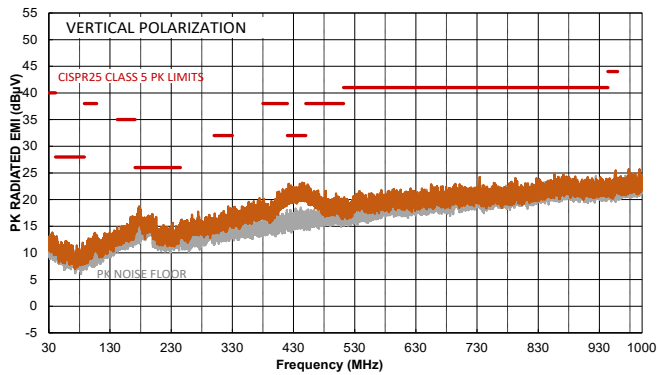

CISPR25 Class 5 Average Radiated Emissions

Vertical, 30MHz to 1GHz

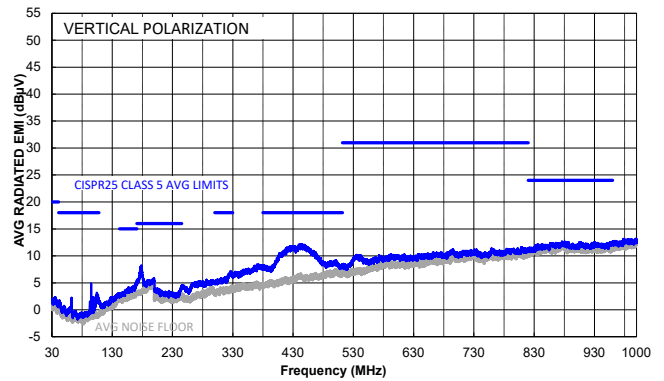

EVB TEST RESULTS (continued)

Performance curves and waveforms are tested on the evaluation board, $V_{IN} = 12V$, $V_{OUT} = 3.3V$, $C_{OUT} = 2 \times 47\mu F$, $L = 5.6\mu H$, $f_{sw} = 410kHz$, $T_A = 25^\circ C$, unless otherwise noted.

Steady State

$I_{OUT} = 0A$, AAM mode

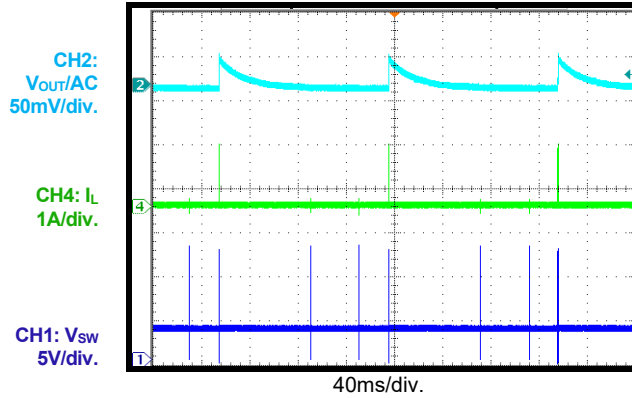

Steady State

$I_{OUT} = 0A$, FCCM

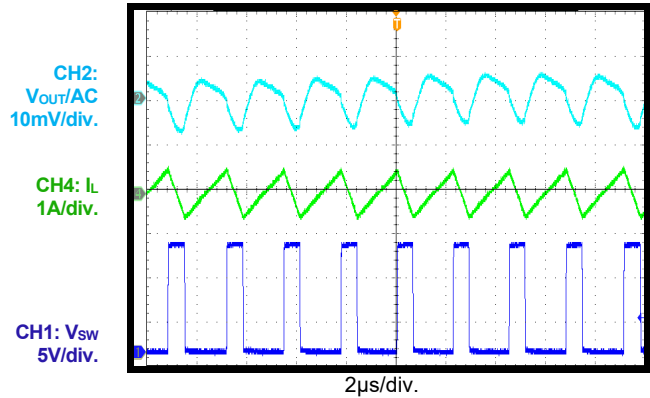

Steady State

$I_{OUT} = 3A$

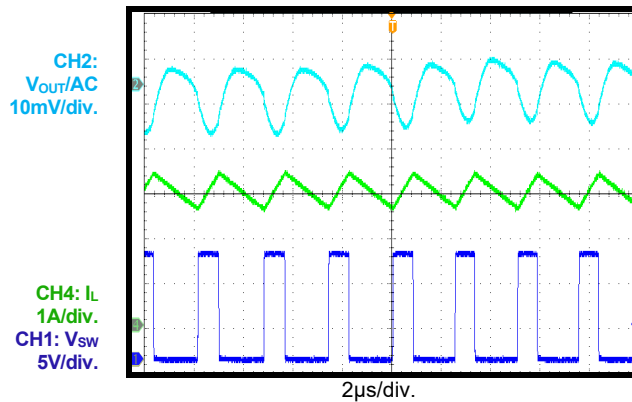

Start-Up through VIN

$I_{OUT} = 0A$, AAM mode

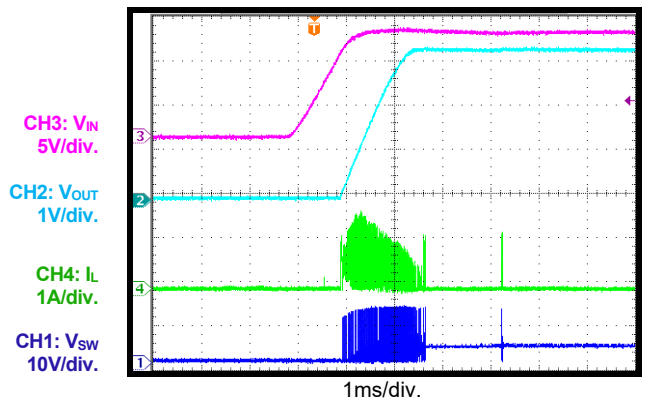

Start-Up through VIN

$I_{OUT} = 0A$, FCCM

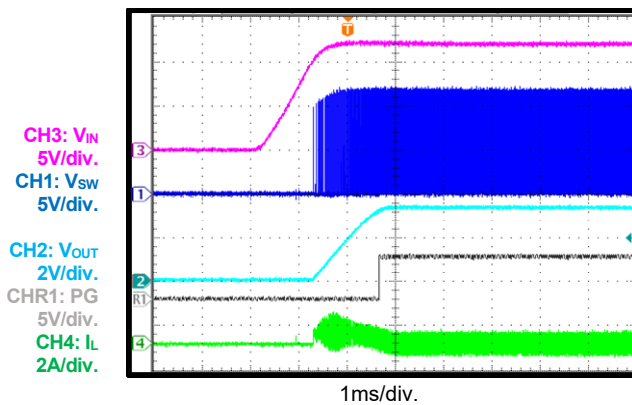

Start-Up through VIN

$I_{OUT} = 3A$

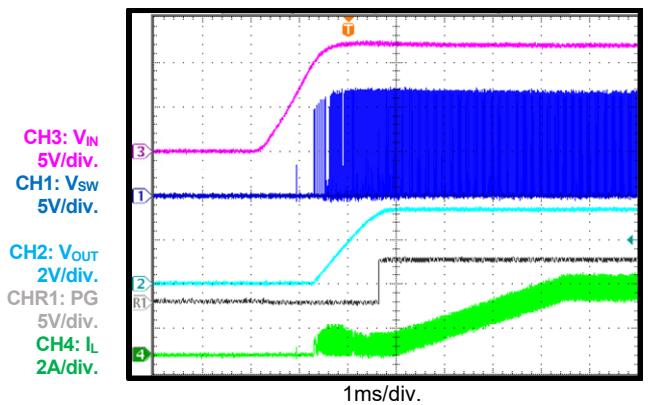

EVB TEST RESULTS (continued)

Performance curves and waveforms are tested on the evaluation board, $V_{IN} = 12V$, $V_{OUT} = 3.3V$, $C_{OUT} = 2 \times 47\mu F$, $L = 5.6\mu H$, $f_{SW} = 410kHz$, $T_A = 25^\circ C$, unless otherwise noted.

Shutdown through VIN

$I_{OUT} = 0A$, AAM mode

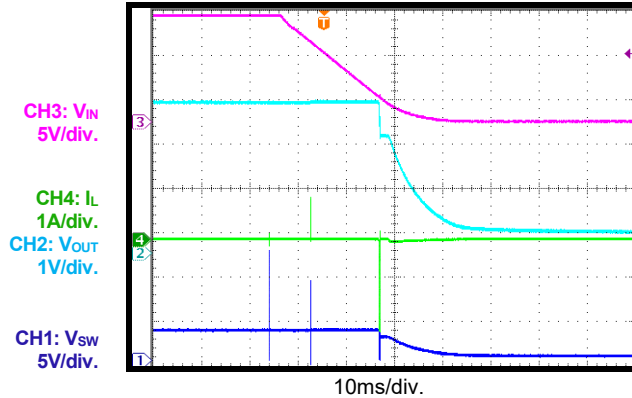

Shutdown through VIN

$I_{OUT} = 0A$, FCCM

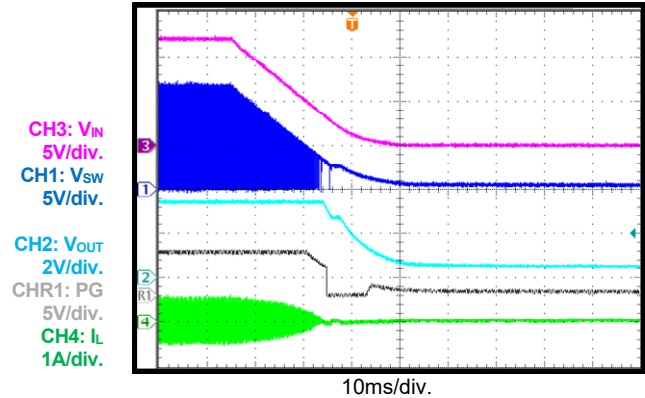

Shutdown through VIN

$I_{OUT} = 3A$

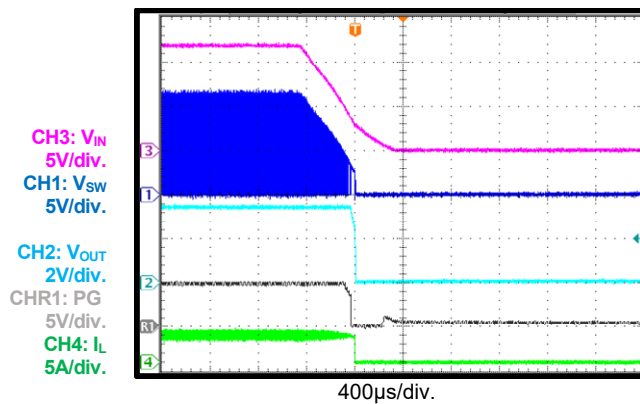

Start-Up through EN

$I_{OUT} = 0A$, AAM mode

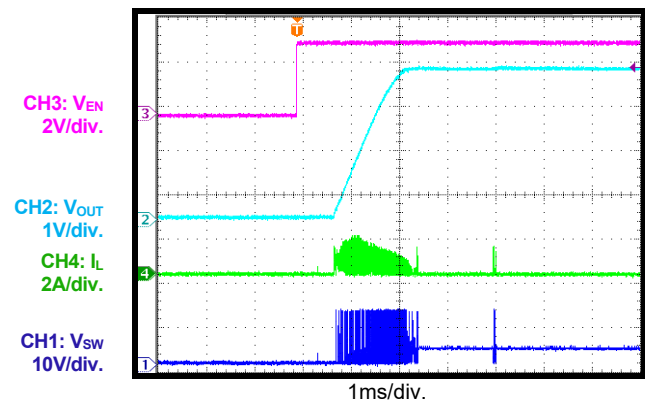

Start-Up through EN

$I_{OUT} = 0A$, FCCM

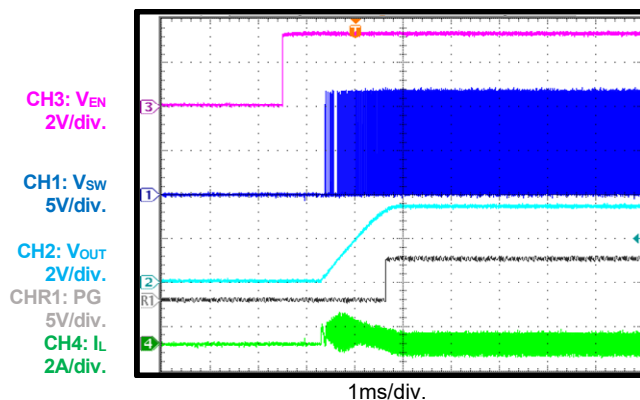

Start-Up through EN

$I_{OUT} = 3A$

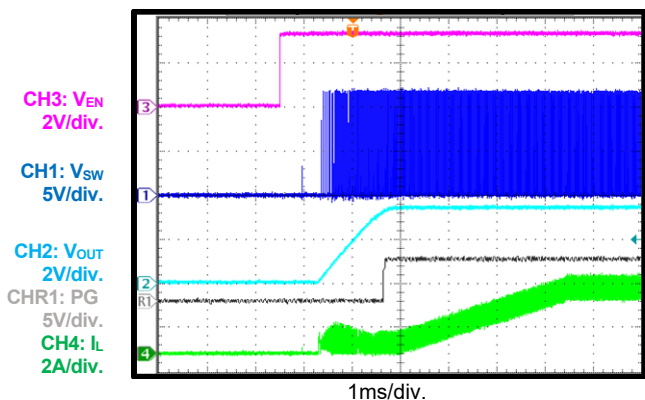

EVB TEST RESULTS (continued)

Performance curves and waveforms are tested on the evaluation board, $V_{IN} = 12V$, $V_{OUT} = 3.3V$, $C_{OUT} = 2 \times 47\mu F$, $L = 5.6\mu H$, $f_{SW} = 410kHz$, $T_A = 25^\circ C$, unless otherwise noted.

Shutdown through EN

$I_{OUT} = 0A$, AAM mode

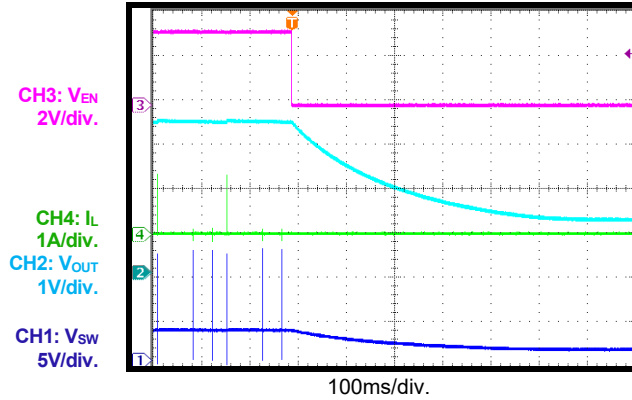

Shutdown through EN

$I_{OUT} = 0A$, FCCM

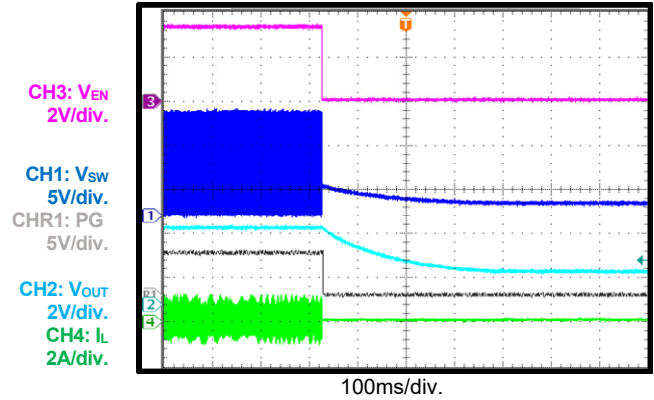

Shutdown through EN

$I_{OUT} = 3A$

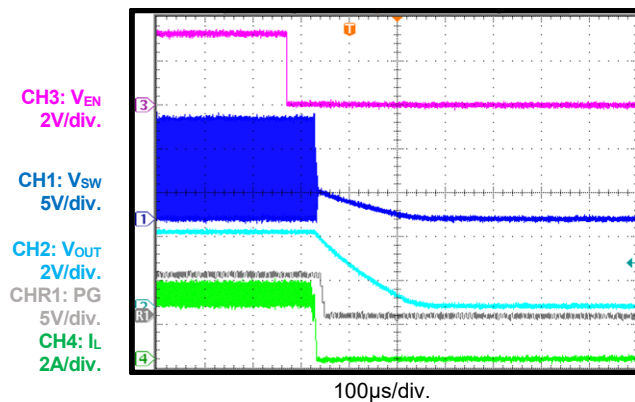

SCP Entry

$I_{OUT} = 0A$, AAM mode

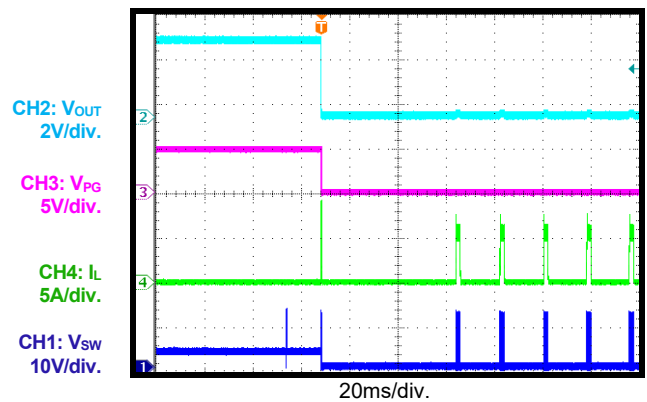

SCP Entry

$I_{OUT} = 0A$, FCCM

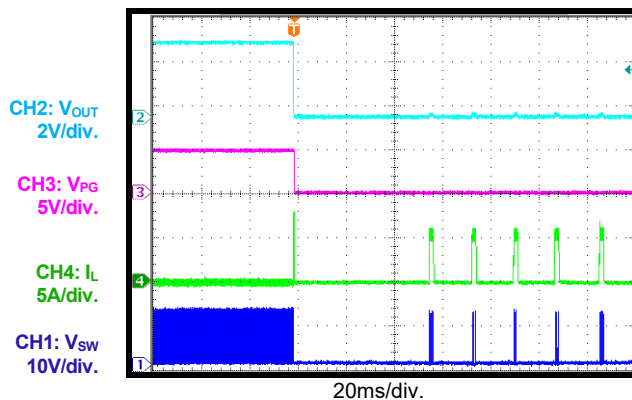

SCP Entry

$I_{OUT} = 3A$

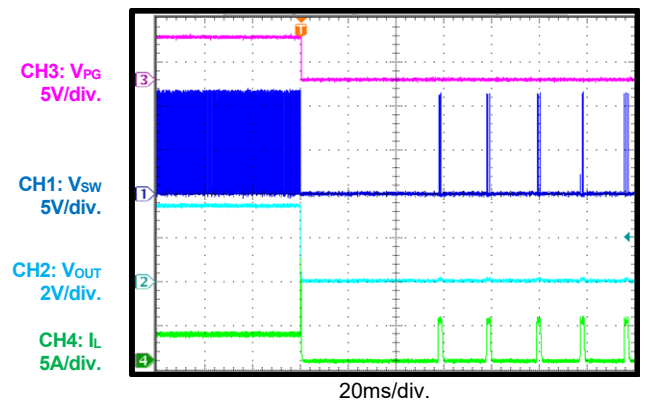

EVB TEST RESULTS (continued)

Performance curves and waveforms are tested on the evaluation board, $V_{IN} = 12V$, $V_{OUT} = 3.3V$, $C_{OUT} = 2 \times 47\mu F$, $L = 5.6\mu H$, $f_{SW} = 410kHz$, $T_A = 25^\circ C$, unless otherwise noted.

SCP Recovery

$I_{OUT} = 0A$, AAM mode

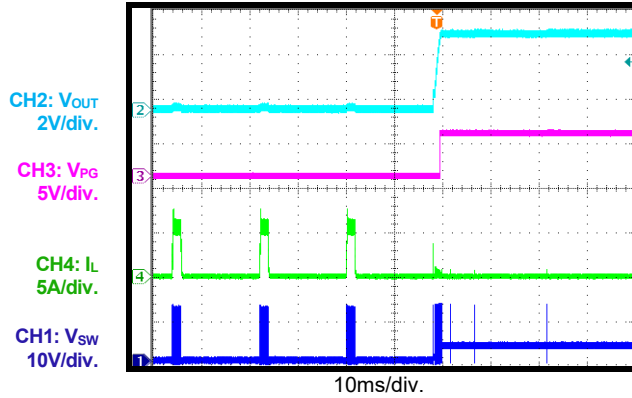

SCP Recovery

$I_{OUT} = 0A$, FCCM

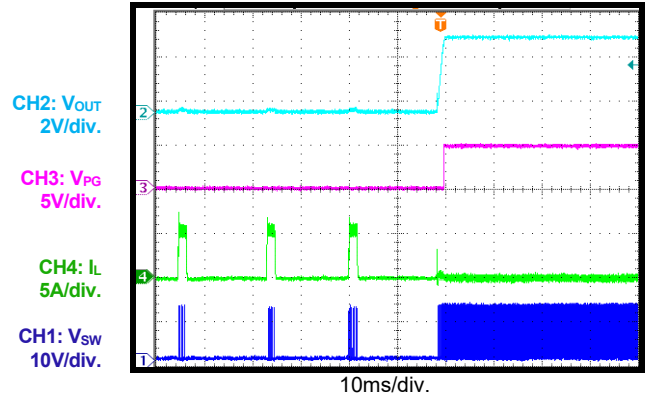

SCP Recovery

$I_{OUT} = 3A$

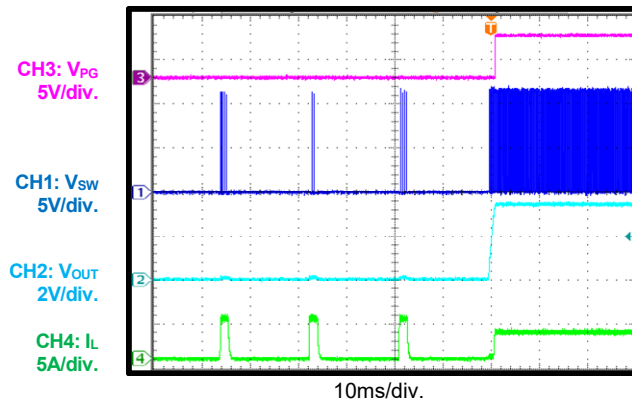

SCP Steady State

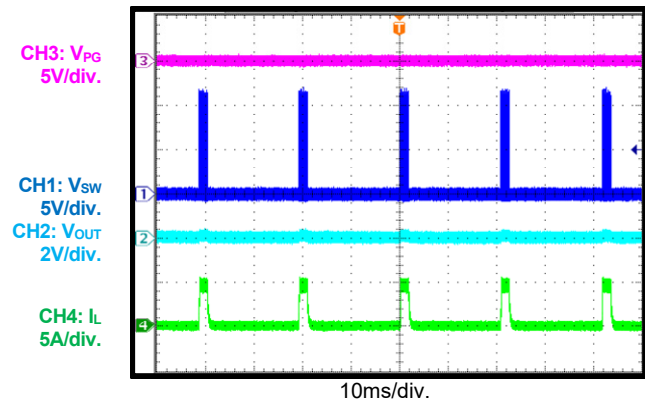

Load Transient

$I_{OUT} = 1.5A$ to $3A$

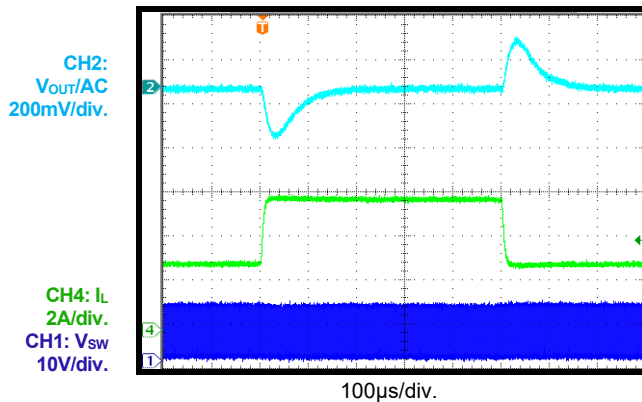

SYNC Operation

$I_{OUT} = 3A$, SYNC frequency = 350kHz

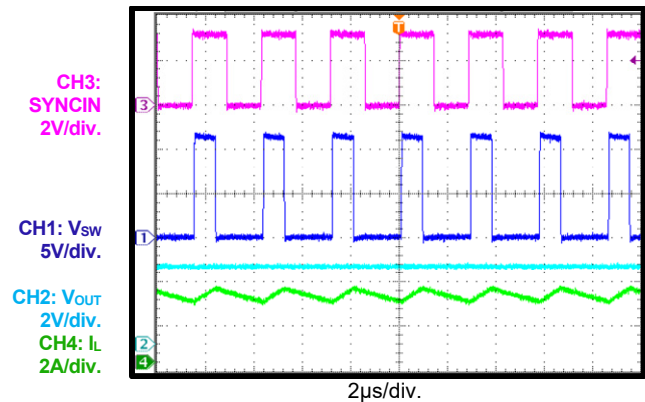

EVB TEST RESULTS (continued)

Performance curves and waveforms are tested on the evaluation board, $V_{IN} = 12V$, $V_{OUT} = 3.3V$, $C_{OUT} = 2 \times 47\mu F$, $L = 5.6\mu H$, $f_{SW} = 410kHz$, $T_A = 25^\circ C$, unless otherwise noted.

SYNC Operation

$I_{OUT} = 3A$, SYNC frequency = 1000kHz

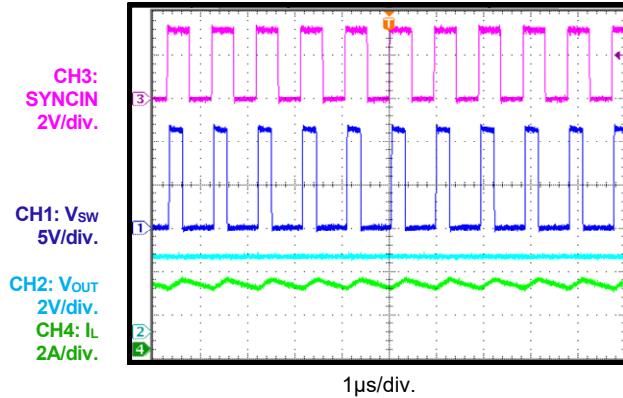

SYNC Operation

$I_{OUT} = 3A$, SYNC frequency = 350kHz

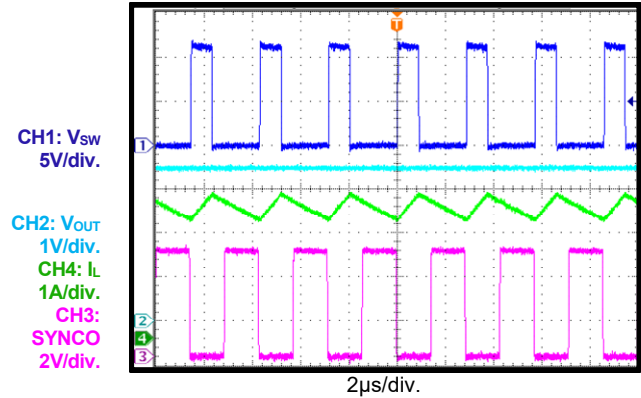

SYNC Operation

$I_{OUT} = 3A$, SYNC frequency = 530kHz

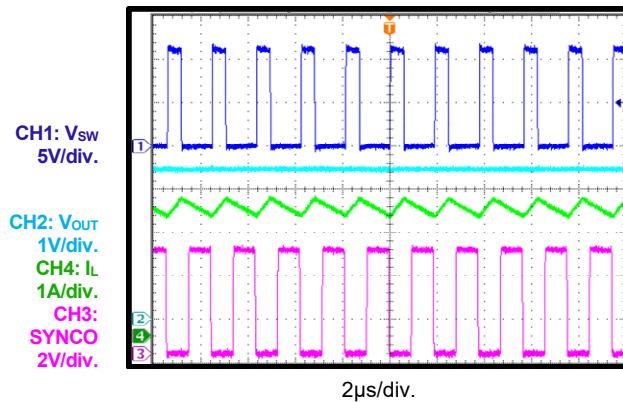

PG in Start-Up through VIN

$I_{OUT} = 0A$, AAM mode

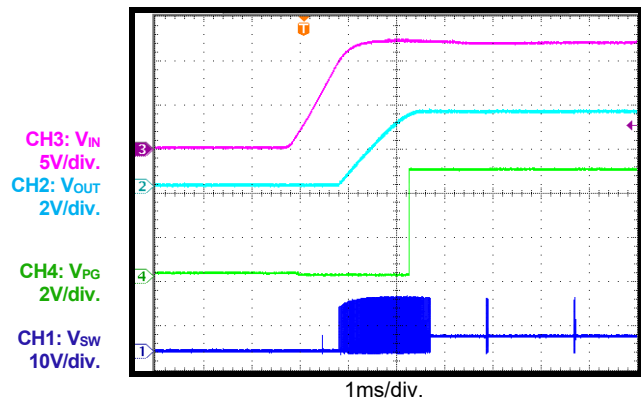

PG in Start-Up through VIN

$I_{OUT} = 3A$

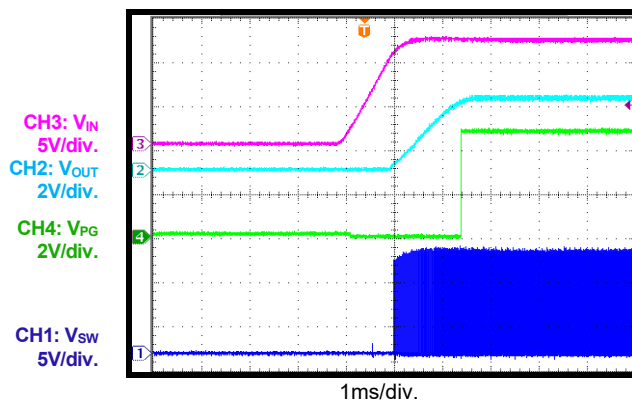

PG in Shutdown through VIN

$I_{OUT} = 0A$, AAM mode

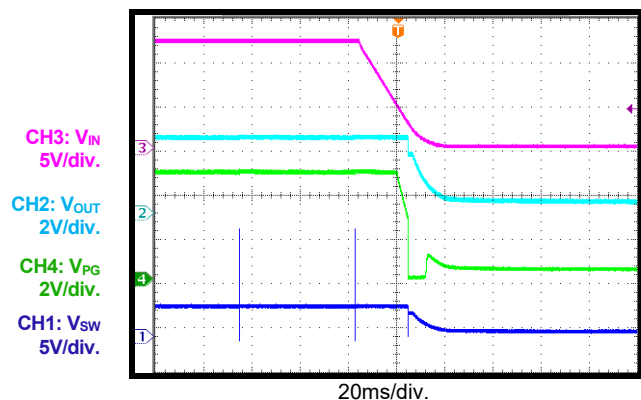

EVB TEST RESULTS (continued)

Performance curves and waveforms are tested on the evaluation board, $V_{IN} = 12V$, $V_{OUT} = 3.3V$, $C_{OUT} = 2 \times 47\mu F$, $L = 5.6\mu H$, $f_{sw} = 410kHz$, $T_A = 25^\circ C$, unless otherwise noted.

PG in Shutdown through VIN

$I_{OUT} = 3A$

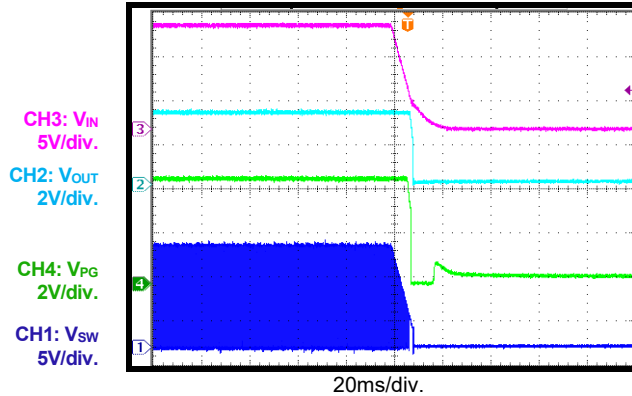

PG in Start-Up through EN

$I_{OUT} = 0A$, AAM mode

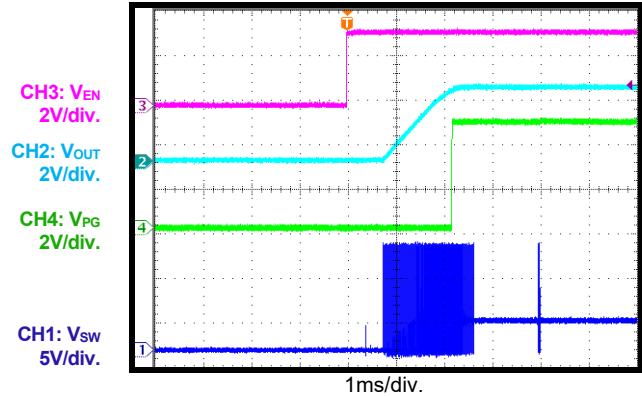

PG in Start-Up through EN

$I_{OUT} = 3A$

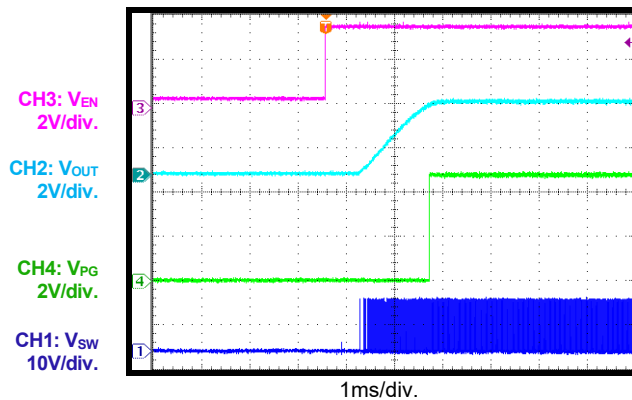

PG in Shutdown through EN

$I_{OUT} = 0A$, AAM mode

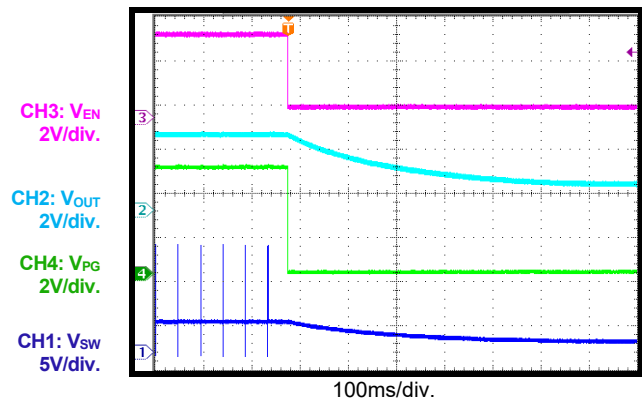

PG in Shutdown through EN

$I_{OUT} = 3A$

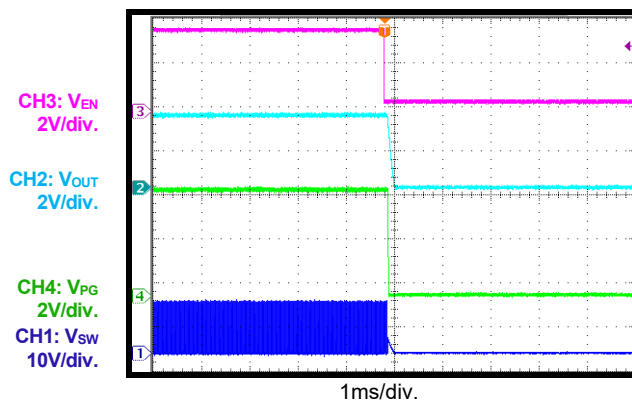

Low-Dropout Mode

$V_{IN} = 3.3V$, V_{OUT} set to 3.3V, $I_{OUT} = 0A$

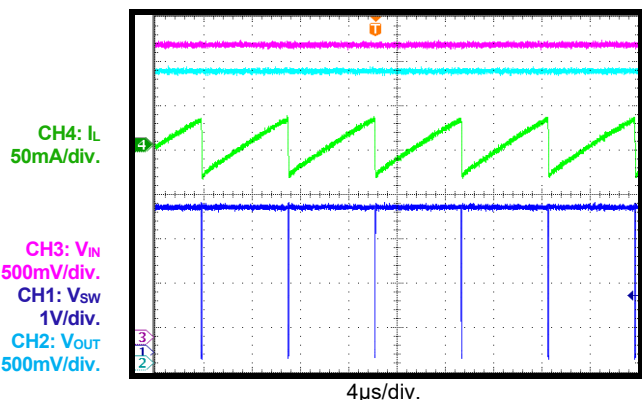

EVB TEST RESULTS (continued)

Performance curves and waveforms are tested on the evaluation board, $V_{IN} = 12V$, $V_{OUT} = 3.3V$, $C_{OUT} = 2 \times 47\mu F$, $L = 5.6\mu H$, $f_{sw} = 410kHz$, $T_A = 25^\circ C$, unless otherwise noted.

Low-Dropout Mode

$V_{IN} = 3.3V$, V_{OUT} set to 3.3V, $I_{OUT} = 3A$

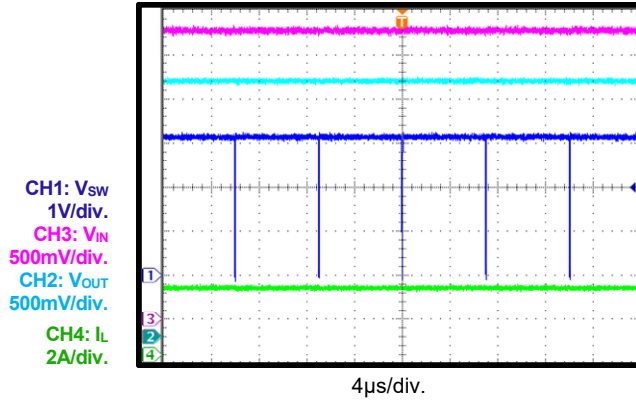

Load Dump

$V_{IN} = 12V$ to 36V, $I_{OUT} = 3A$

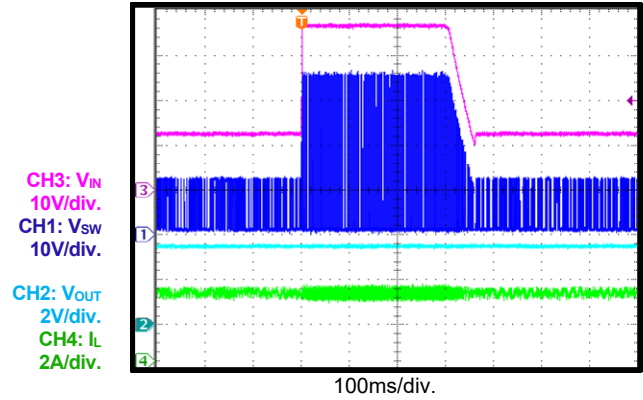

Cold Crank

$V_{IN} = 12V$ to 3.3V to 5V, $I_{OUT} = 3A$

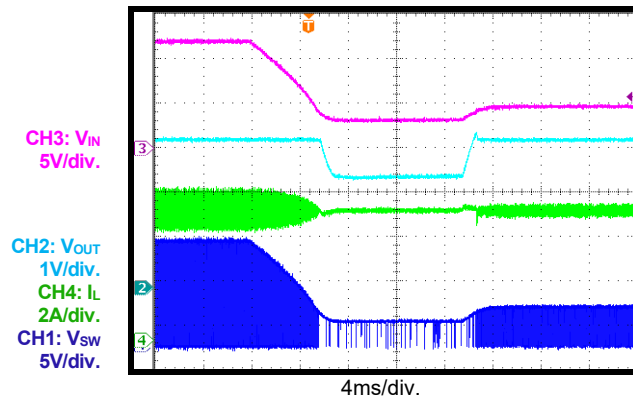

V_{IN} Ramping Up and Down

$I_{OUT} = 0.1A$

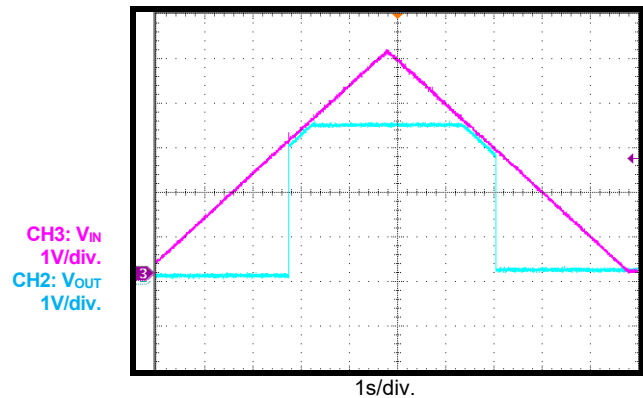

V_{IN} Ramping Down and Up

$I_{OUT} = 1mA$

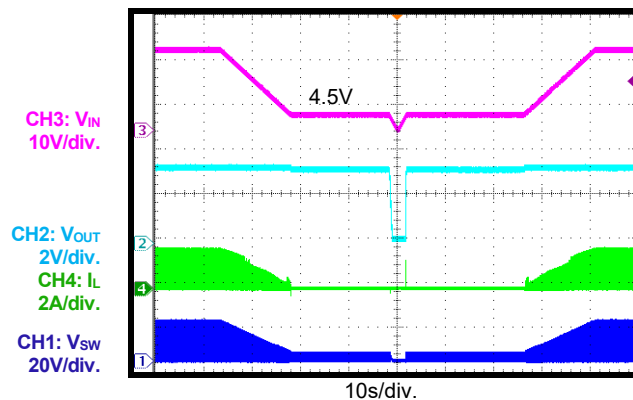

V_{IN} Ramping Down and Up

$I_{OUT} = 3A$

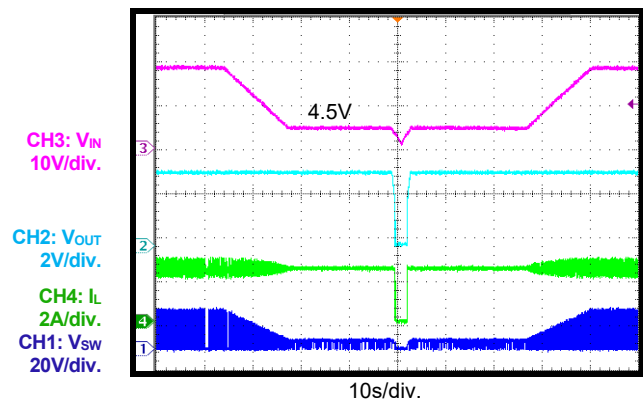

PCB LAYOUT (2)

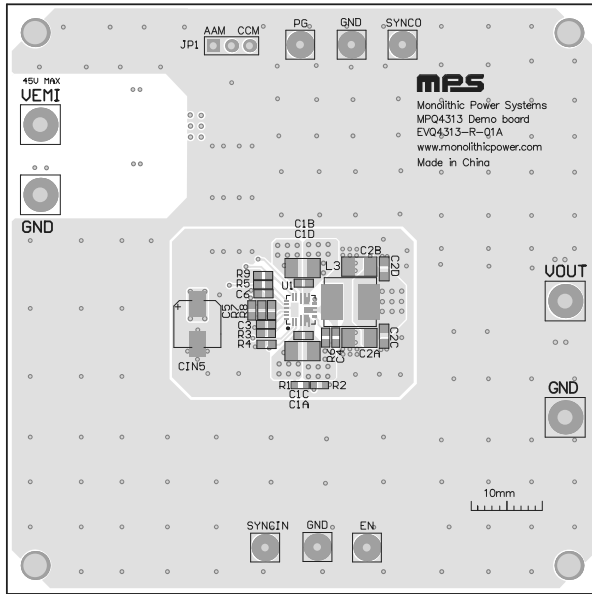

Figure 4: Top Silk and Top Layer

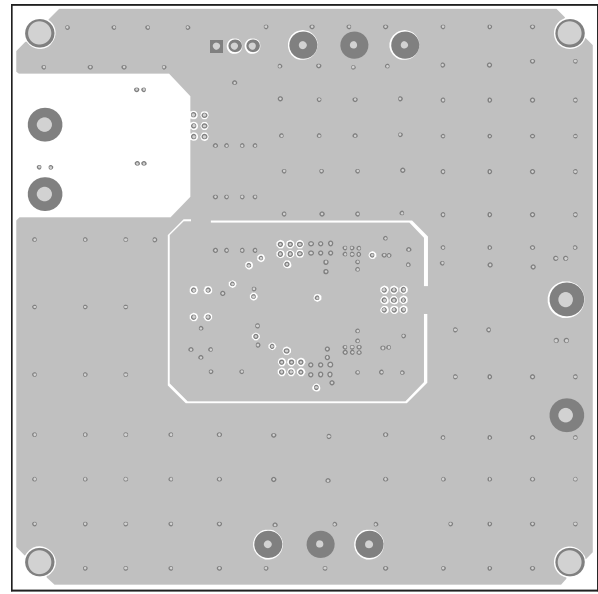

Figure 5: Mid-Layer 1

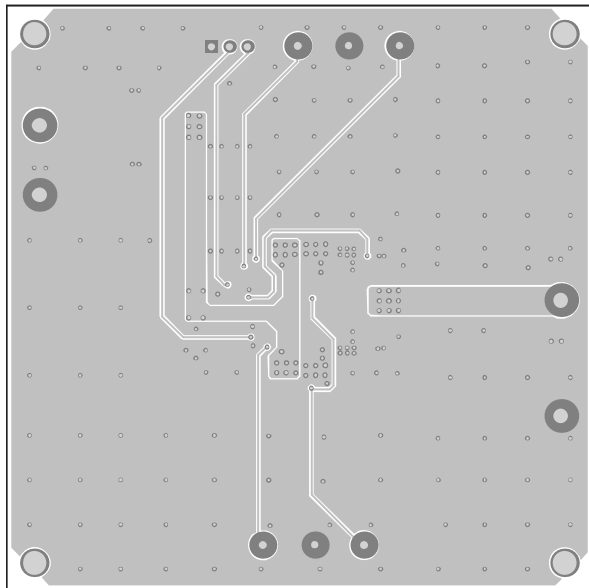

Figure 6: Mid-Layer 2

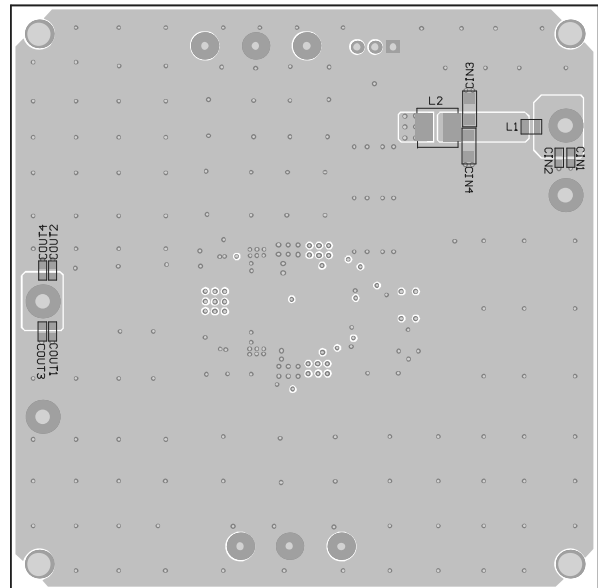

Figure 7: Bottom Layer and Bottom Silk

Note:

- 2) The copper thickness is 2oz.



REVISION HISTORY

Revision #	Revision Date	Description	Pages Updated
1.0	5/26/2022	Initial Release	-

Notice: The information in this document is subject to change without notice. Please contact MPS for current specifications. Users should warrant and guarantee that third-party Intellectual Property rights are not infringed upon when integrating MPS products into any application. MPS will not assume any legal responsibility for any said applications.