



MN1400

Size: C (LR14)

Alkaline-Manganese Dioxide Battery

Zn/MnO₂

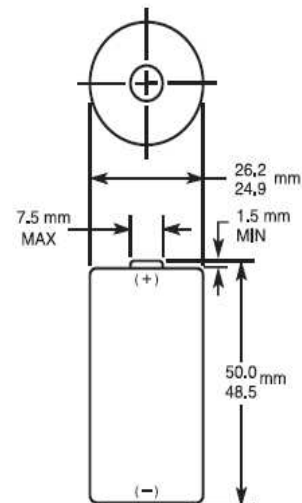

Dimensions shown are IEC standards

Nominal voltage	1.5 V
Impedance	130 m-ohm @ 1 kHz
Typical weight	71 g (2.4 oz)
Typical volume	26.9 cm ³ (1.6 in ³)
Terminals	Flat
Storage temperature range	6°C to 29°C (42°F to 85°F)
Operating temperature range	-20°C to 54°C (-4°F to 130°F)
Designation	ANSI: 14A IEC: LR14

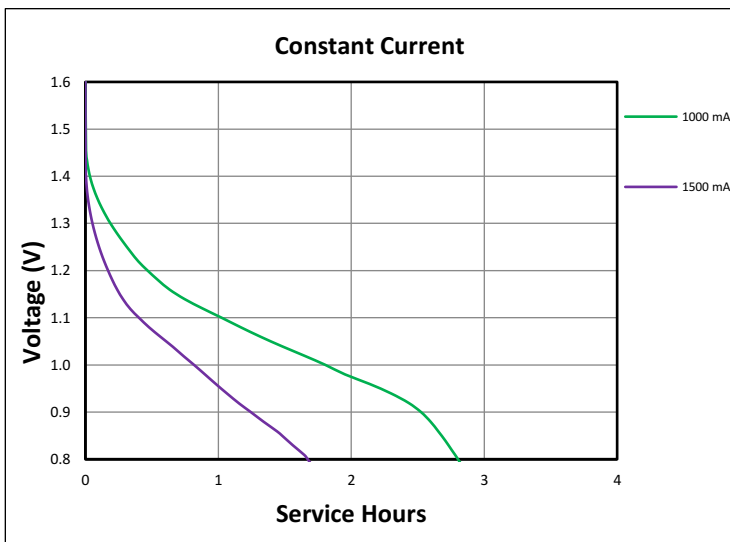
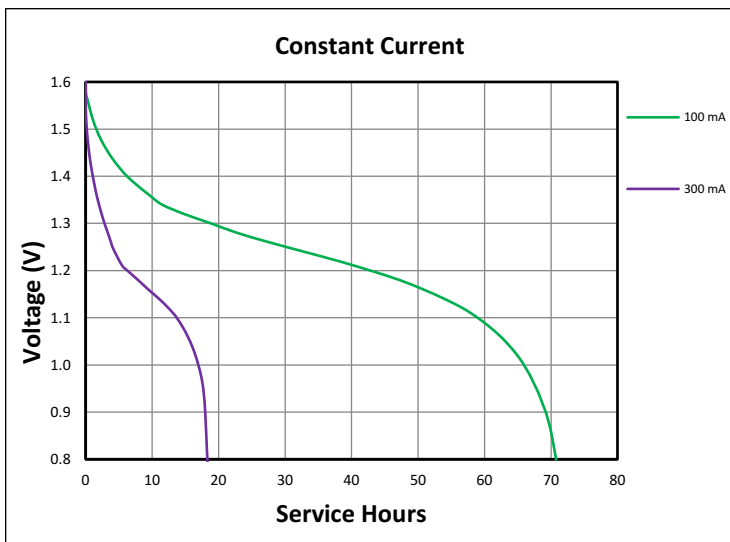

Berkshire Corporate Park
Bethel, CT. 06801 U.S.A.
Telephone: Toll-free 1-800-544-5454
www.duracell.com

Delivered capacity is dependent on the applied load, operating temperature and cut-off voltage. Please refer to the charts and discharge data shown for examples of the energy/service life that the battery will provide for various load conditions.



MN1400

Size: C (LR14)

Alkaline-Manganese Dioxide Battery

Zn/MnO₂

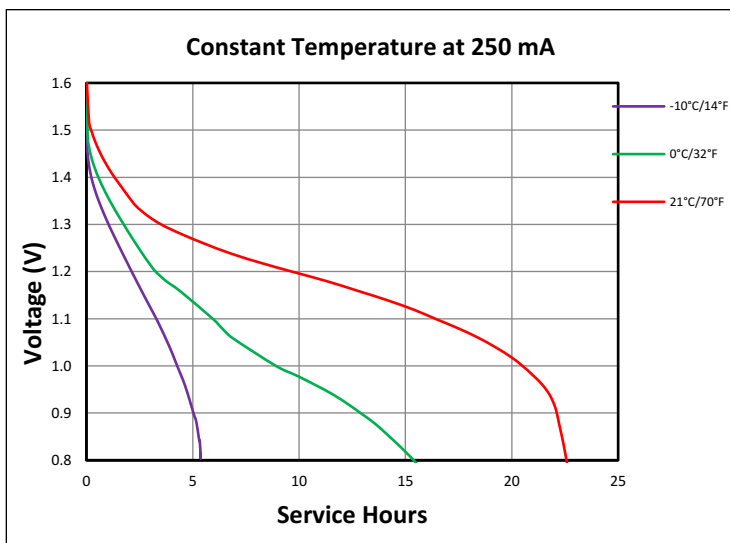
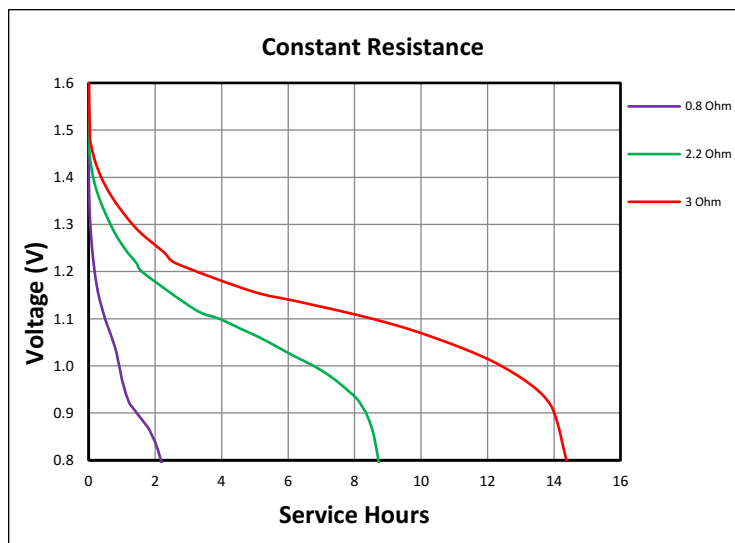
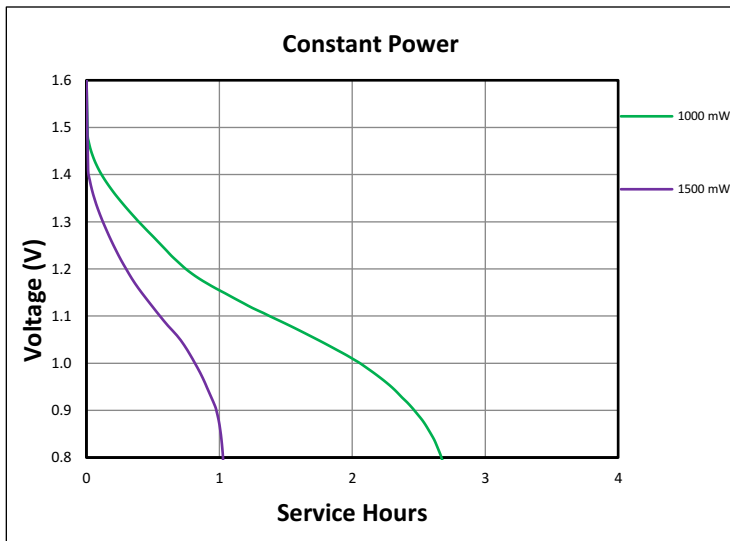
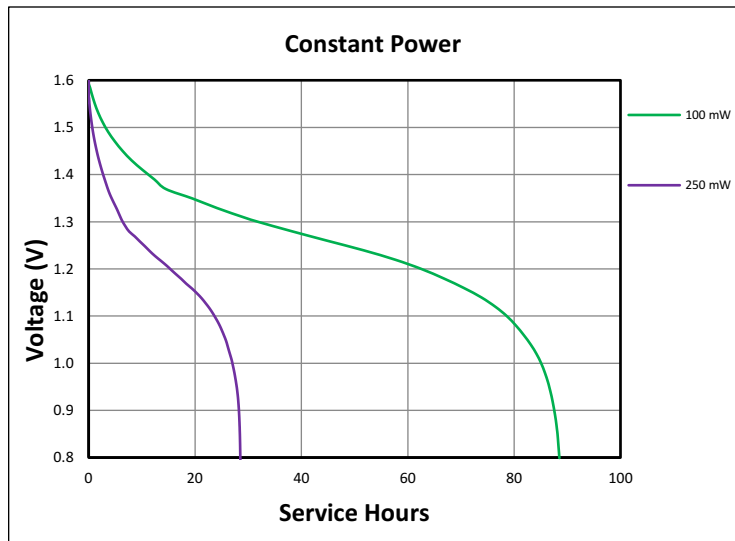

Berkshire Corporate Park
Bethel, CT. 06801 U.S.A.
Telephone: Toll-free 1-800-544-5454
www.duracell.com

Delivered capacity is dependent on the applied load, operating temperature and cut-off voltage. Please refer to the charts and discharge data shown for examples of the energy/service life that the battery will provide for various load conditions.