

03

WSV ... C

Circular connectors with threaded joint M16 acc. to IEC 61076-2-106, IP40/IP68



Plug acc. to IEC 61076-2-106, IP40, angular version, with threaded joint, empty housing for reception of crimp contacts, with bend protection, for cable diameter up to 6 mm

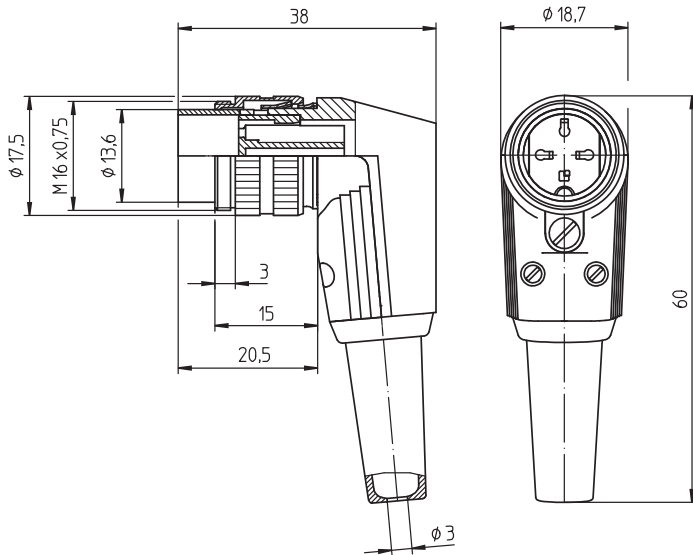

Pin configurations, crimp side view

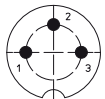

03-a  
WSV 30 C

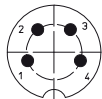

04-a  
WSV 40 C

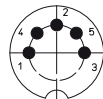

05-b  
WSV 50 C

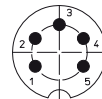

05-a  
WSV 50/6 C

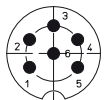

06-a  
WSV 60 C

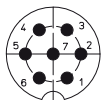

07-a  
WSV 70 C

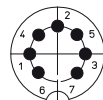

07-b  
WSV 71 C

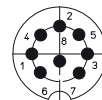

08-a  
WSV 81 C

Environmental conditions

Temperature range -40 °C/+85 °C

Materials

Insulating body	PA GF, V-0 according to UL94
Ground contact spring	CuZn, pre-nickel and tin-plated
Sleeve	PC, HB according to UL94
Strain relief	steel, nickel-plated
Housing	CuZn, nickel-plated
Knurled screw	CuZn, nickel-plated
Bend protection sleeve	TPE
Screw	steel, nickel-plated

Mechanical data

Tightening torque connector 1–3 Nm  
Protection class IP40<sup>1</sup>

<sup>1</sup> according to IEC DIN EN 60529, only in locked condition with an appropriate counterpart

Connectable conductors for crimp area

Cable diameter 4–6 mm

Electrical data (at T<sub>amb</sub> 20 °C)

Rated current 5 A (T<sub>amb</sub> 40 °C)  
Rated voltage with pollution degree 1:  
300 V (versions 30, 40, 50/6, 60, 70)  
100 V (versions 50, 71, 80, 81)  
with pollution degree 2:  
250 V (versions 30, 40)  
32 V (versions 50, 71, 80, 81)  
160 V (versions 50/6, 60, 70)  
Rated impulse voltage 1500 V (versions 30, 40, 50/6, 60, 70)  
500 V (versions 50, 71, 80, 81)  
Material group II (IEC)/I (UL) (400 ≤ CTI < 600)  
Overvoltage category I  
Insulation resistance > 100 MΩ

Associated products

Counterparts		
☞ 030398	☞ KFR	☞ KFR
☞ KFV	☞ KFV ... C	☞ KGR
☞ KGV	☞ KGV ... C	☞ KV
☞ KV ... C	☞ KV ...-8	☞ KV ...-8 C

---

<a href="#">🔗 WKV</a>	<a href="#">🔗 WKV ... C</a>	
Accessories		
<a href="#">🔗 0369</a>	<a href="#">🔗 0383</a>	<a href="#">🔗 038399</a>
<a href="#">🔗 038899</a>		

---

03

WSV ... C

Designation	Pole Number	PU (Pieces)	MDQ (Pieces)
WSV 30 C	3	50	100
WSV 40 C	4	50	100
WSV 50 C	5	50	100
WSV 50/6 C	5	50	100
WSV 60 C	6	50	100
WSV 70 C	7	50	100
WSV 71 C	7	50	100
WSV 81 C	8	50	100

**Packaging:**

preassembled, in a cardboard box