

No.	Changes and/or Note	Date	Intr	No	Changes and/or Note	Date	Intr

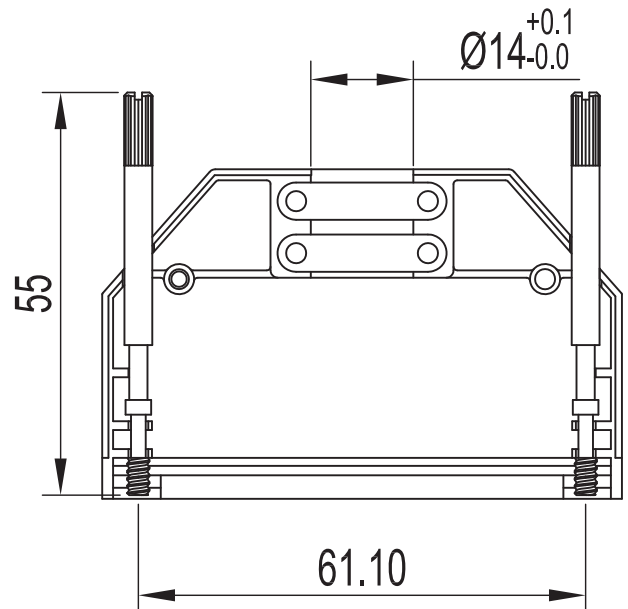
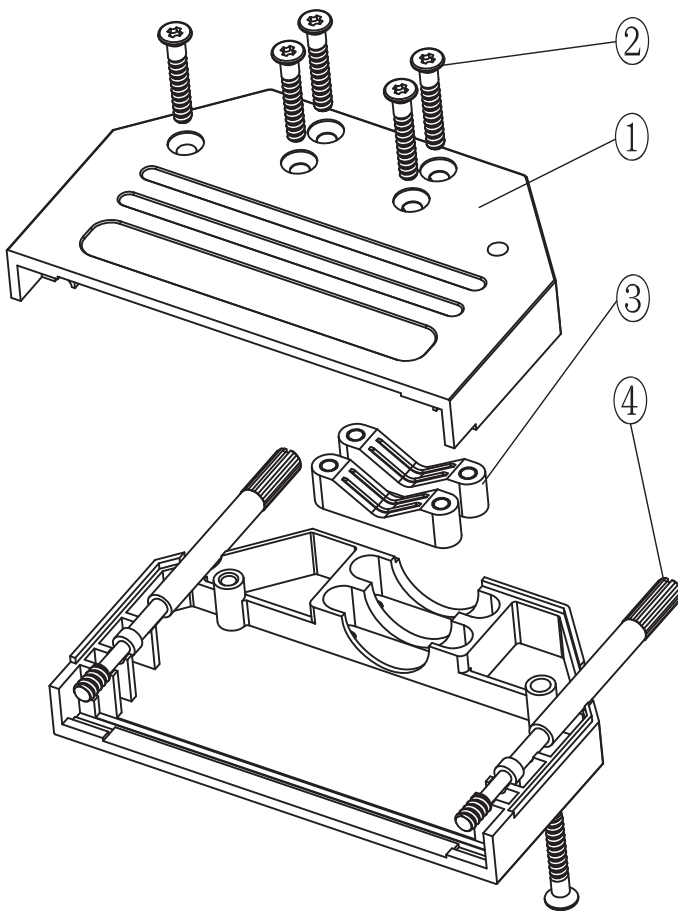
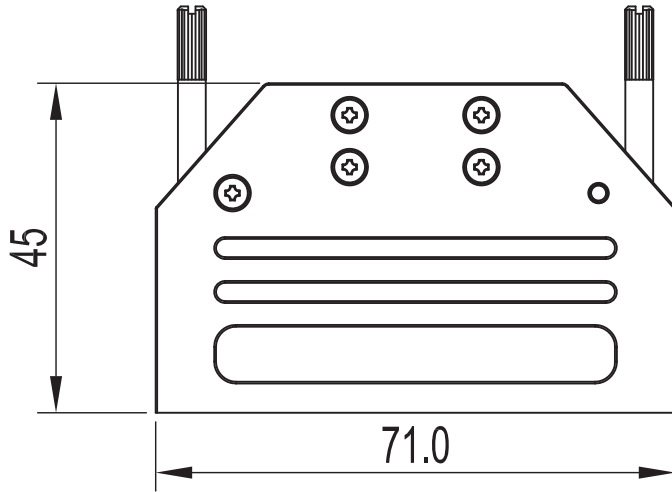

Part Number:	Description:	Pack:	Item	QTY	Part description
6560-0305-05	DTZI50-K	Kit	1	2	DTZI50 Cover
6561-0305-05	DTZI50	Bulk	2	6	M2.5X16 Countersunk screw
			3	2	DTZI50-Clamp
			4	2	UNC 4-40X55 Jackscrew
DATE: 2011-04-12	DRAWN: MRR	SCALE:	MATERIAL TYPE:		GENERAL TOLERANCES UNLESS OTHERWISE STATED LINEAR 0 ±0.20 0.0 ±0.15 0.00 ±0.10 ANGULAR ±0°30' ALL DIMENSIONS IN mm THIRD ANGLE PROJECTION
	APPROVED:		REPLACES:		
		DTZI-SERIES			
				DRAWING No: 6688-9605	