

GaAs-IR-Lumineszenzdiode GaAs Infrared Emitter

LD 261

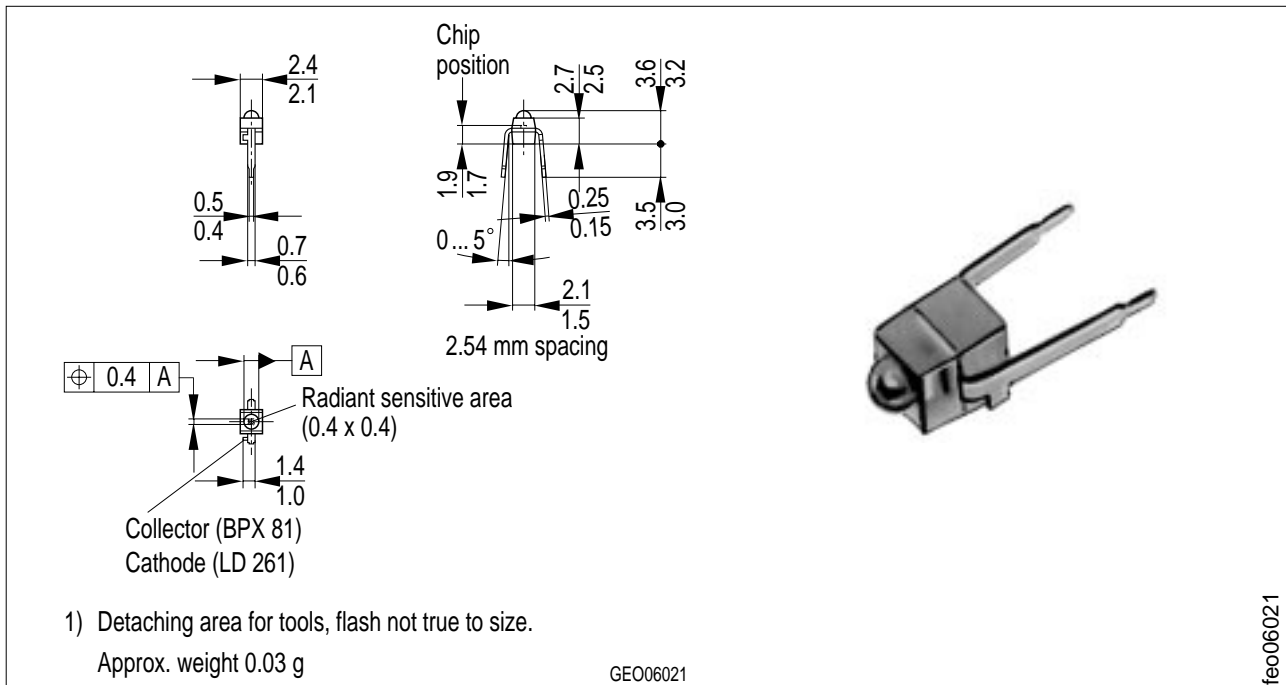

Maße in mm, wenn nicht anders angegeben/Dimensions in mm, unless otherwise specified.

Wesentliche Merkmale

- GaAs-IR-Lumineszenzdiode, hergestellt im Schmelzepitaxieverfahren
- Hohe Zuverlässigkeit
- Gruppiert lieferbar
- Gehäusegleich mit BPX 81

Anwendungen

- Miniaturlichtschranken für Gleich- und Wechsellichtbetrieb
- Lochstreifenleser
- Industrieelektronik
- "Messen/Steuern/Regeln"

Features

- GaAs infrared emitting diode, fabricated in a liquid phase epitaxy process
- High reliability
- Available in bins
- Same package as BPX 81

Applications

- Miniature photointerrupters
- Punched tape readers
- Industrial electronics
- For control and drive circuits

Typ Type	Bestellnummer Ordering Code	Gehäuse Package
LD 261	Q62703-Q395	Leiterbandgehäuse, klares Epoxy-Gießharz, linsenförmig im 2.54-mm-Raster ($1/10''$), Kathodenkennzeichnung: Nase am Lötspieß Lead frame, transparent epoxy resin lens, solder tabs lead spacing 2.54 mm ($1/10''$), cathode marking: projection at solder lead
LD 261-5	Q62703-Q67	

Grenzwerte ($T_A = 25\text{ °C}$)

Maximum Ratings

Bezeichnung Description	Symbol Symbol	Wert Value	Einheit Unit
Betriebs- und Lagertemperatur Operating and storage temperature range	$T_{op}; T_{stg}$	- 40 ... + 80	°C
Sperrschichttemperatur Junction temperature	T_j	80	°C
Sperrspannung Reverse voltage	V_R	5	V
Durchlaßstrom Forward current	I_F	50	mA
Stoßstrom, $\tau \leq 10\ \mu\text{s}$, $D = 0$ Surge current	I_{FSM}	1.6	A
Verlustleistung Power dissipation	P_{tot}	70	mW
Wärmewiderstand Thermal resistance	R_{thJA} R_{thJL}	750 650	K/W K/W

Kennwerte ($T_A = 25\text{ °C}$)

Characteristics

Bezeichnung Description	Symbol Symbol	Wert Value	Einheit Unit
Wellenlänge der Strahlung Wavelength at peak emission $I_F = 50\text{ mA}$, $t_p = 20\text{ ms}$	λ_{peak}	950	nm
Spektrale Bandbreite bei 50 % von I_{max} Spectral bandwidth at 50 % of I_{max} $I_F = 50\text{ mA}$, $t_p = 20\text{ ms}$	$\Delta\lambda$	55	nm
Abstrahlwinkel Half angle	φ	± 15	Grad deg.
Aktive Chipfläche Active chip area	A	0.25	mm ²
Abmessungen der aktiven Chipfläche Dimension of the active chip area	$L \times B$ $L \times W$	0.5×0.5	mm
Abstand Chipoberfläche bis Linsenscheitel Distance chip surface to lens top	H	1.3 ... 1.9	mm

Kennwerte ($T_A = 25\text{ °C}$)

Characteristics

Bezeichnung Description	Symbol Symbol	Wert Value	Einheit Unit
Schaltzeiten, I_e von 10 % auf 90 % und von 90 % auf 10 %, bei $I_F = 50\text{ mA}$, $R_L = 50\ \Omega$ Switching times, I_e from 10 % to 90 % and from 90 % to 10 %, $I_F = 50\text{ mA}$, $R_L = 50\ \Omega$	t_r, t_f	1	μs
Kapazität, $V_R = 0\text{ V}$ Capacitance	C_o	40	pF
Durchlaßspannung Forward voltage $I_F = 50\text{ mA}$, $t_p = 20\ \mu\text{s}$	V_F	1.25 (≤ 1.4)	V
Sperrstrom, $V_R = 5\text{ V}$ Reverse current	I_R	0.01 (≤ 1)	μA
Gesamtstrahlungsfluß Total radiant flux $I_F = 50\text{ mA}$, $t_p = 20\text{ ms}$	Φ_e	9	mW
Temperaturkoeffizient von I_e bzw. Φ_e , $I_F = 50\text{ mA}$ Temperature coefficient of I_e or Φ_e , $I_F = 50\text{ mA}$	TC_I	- 0.55	%/K
Temperaturkoeffizient von V_F , $I_F = 50\text{ mA}$ Temperature coefficient of V_F , $I_F = 50\text{ mA}$	TC_V	- 1.5	mV/K
Temperaturkoeffizient von λ_{peak} , $I_F = 50\text{ mA}$ Temperature coefficient of λ_{peak} , $I_F = 50\text{ mA}$	TC_λ	0.3	nm/K

Gruppierung der Strahlstärke I_e in Achsrichtung

gemessen bei einem Raumwinkel $\Omega = 0.01\text{ sr}$

Grouping of radiant intensity I_e in axial direction

at a solid angle of $\Omega = 0.01\text{ sr}$

Bezeichnung Description	Symbol	Werte Values		Einheit Unit
		LD 261	LD 261-5	
Strahlstärke Radiant intensity $I_F = 50\text{ mA}$, $t_p = 20\text{ ms}$	I_e	2 ... 6.3	3.2 ... 6.3	mW/sr

Relative spectral emission

$$I_{rel} = f(\lambda)$$

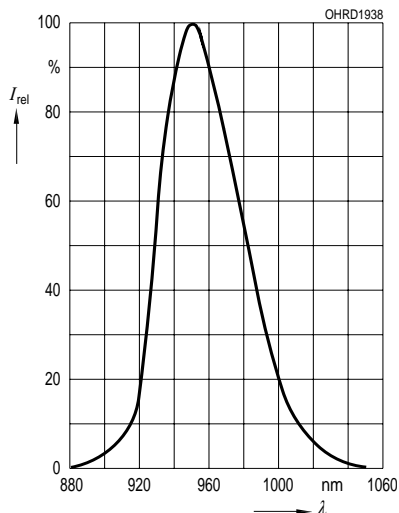

Radiant intensity

$$\frac{I_e}{I_e(100 \text{ mA})} = f(I_F)$$

Single pulse, $t_p = 20 \mu\text{s}$

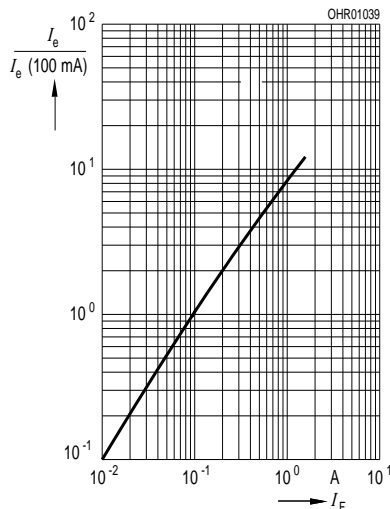

Max. permissible forward current

$$I_F = f(T_A)$$

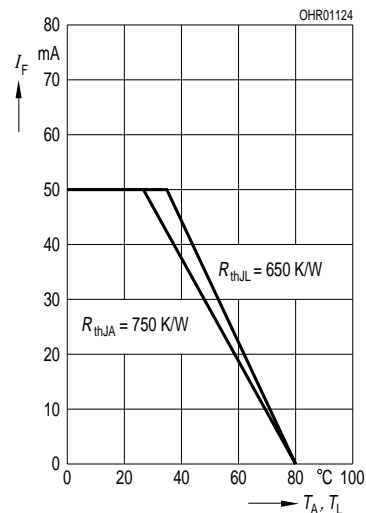

Forward current

$$I_F = f(V_F), \text{ single pulse, } t_p = 20 \mu\text{s}$$

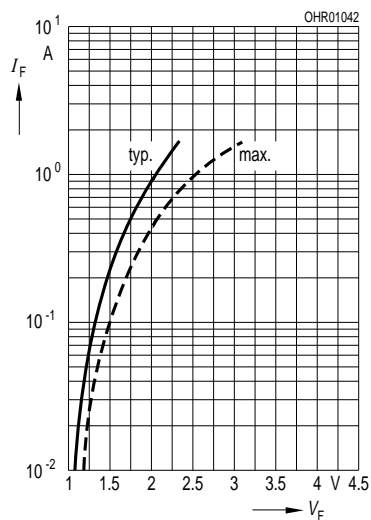

Permissible pulse handling capability

$$I_F = f(\tau), T_C = 25 \text{ }^\circ\text{C},$$

duty cycle $D =$ parameter

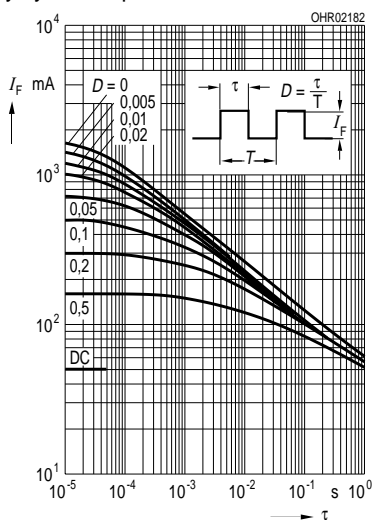

Radiation characteristics

$$I_{rel} = f(\varphi)$$

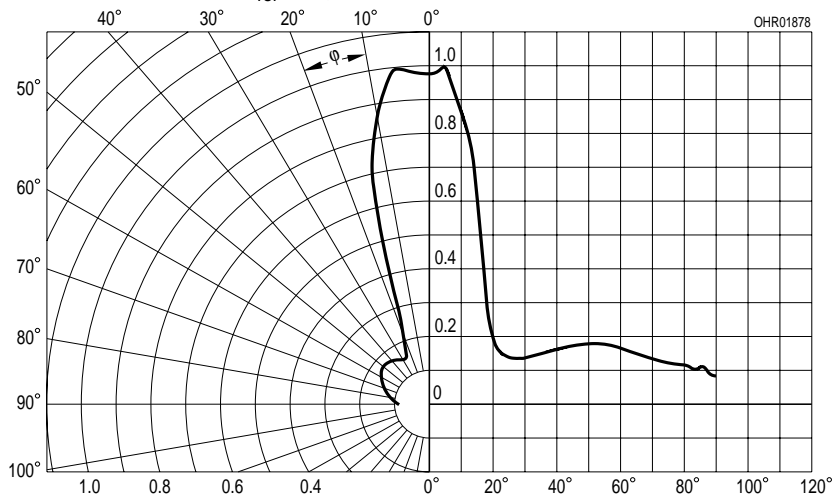

This datasheet has been download from:

www.datasheetcatalog.com

Datasheets for electronics components.