

Pressure Sensor

FFXP029

Part Number

InoxSens UniBar



- FDA compliant
- Hygienic design makes it easy to clean
- Piggable with flush mounting
- Robust stainless steel housing with IP69K
- Space-saving process connection thanks to small pressure membrane

UniBar pressure sensors measure the relative pressure in closed systems of any medium in the range -1...600 bar.

UniBar pressure sensors are very easy to use thanks to the removable cover on the integrated display. The highly visible switching status display enables the rapid localization of affected sensors for maintenance processes.

Thanks to the metallic sealing edge on the process connection, no further seals are required.

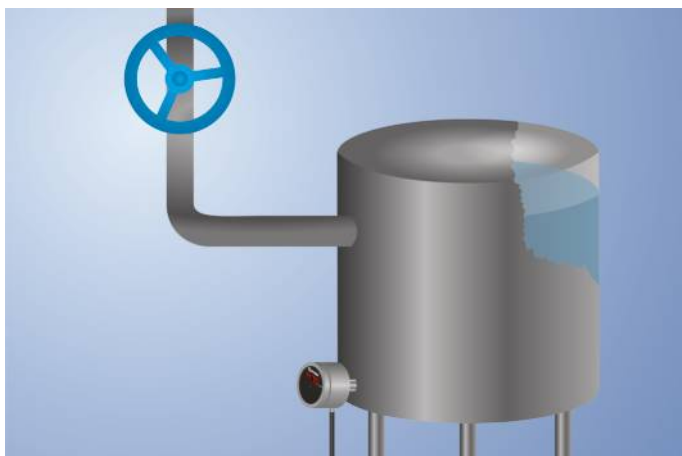

Technical Data

Sensor-specific data	
Measuring Range	0...25 bar
Maximum overload pressure	50 bar
Bursting pressure	100 bar
Adjustable Range	4...100 %
Medium	Liquids, gases
Switching Hysteresis	2 %
Measuring error	< ± 0,5 %
Temperature Drift	0,025 %/K
Environmental conditions	
Temperature of medium	-25...60 °C
Ambient temperature	-25...80 °C
EMC	DIN EN 61326-2-3
Shock resistance per DIN IEC 68-2-27	30 g / 11 ms
Vibration resistance per DIN IEC 60068-2-6	20 g (10...2000 Hz)
Electrical Data	
Supply Voltage	16...32 V DC
Current Consumption (U _b = 24 V)	< 60 mA
Switching Outputs	1
Response Time	1,2 s
Relay Output/Switching Current (24 VDC)	< 1 A
Analog Output	0...10 V Press
Resolution	10 bit
Current Load Voltage Output	< 20 mA
Short Circuit Protection	yes
Reverse Polarity Protection	yes
Protection Class	III
Mechanical Data	
Setting Method	Menu
Housing Material	1.4404; PC; EPDM
Material Control Panel	Polyester
Material in contact with media	1.4435; 1.4404
Degree of Protection	IP67/IP69K *
Connection	M12 × 1; 5-pin
Process Connection	G 1/2" CIP-capable
Safety-relevant Data	
MTTFd (EN ISO 13849-1)	769,77 a
Analog Output	●
Final value, analog output: scalable 2:1	●
PNP NO/NC switchable	●
Connection Diagram No.	1003
Control Panel No.	A13
Suitable Connection Technology No.	21
Suitable Mounting Technology No.	905 906

* Tested by wenglor

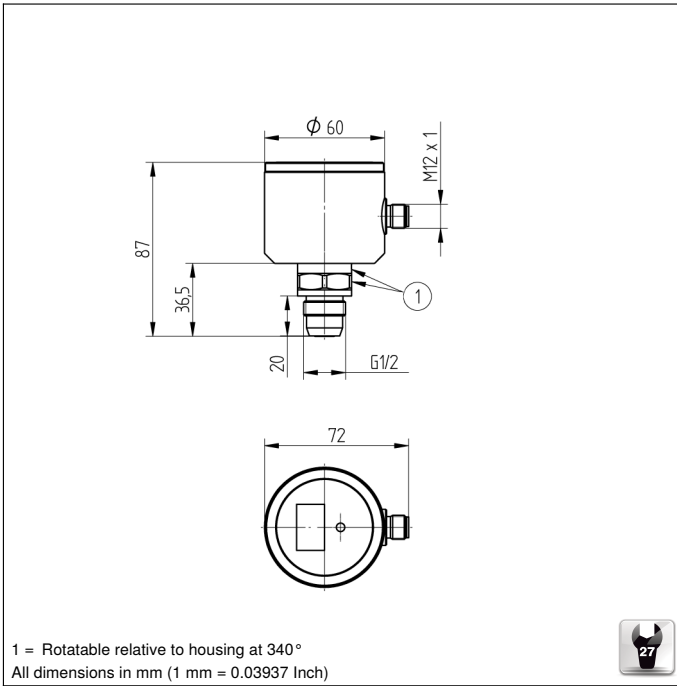

Ctrl. Panel



- 01 = Switching Status Indicator
- 0A = Detachable lid
- 20 = Enter Button
- 22 = UP Button
- 60 = Display
- 99 = Right button

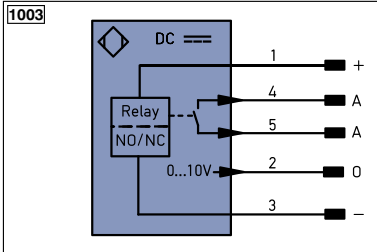

Legend

+	Supply Voltage +	PT	Platinum measuring resistor	ENa	Encoder A
-	Supply Voltage 0 V	nc	not connected	ENb	Encoder B
~	Supply Voltage (AC Voltage)	U	Test Input	AMIN	Digital output MIN
A	Switching Output (NO)	U	Test Input inverted	AMAX	Digital output MAX
Ā	Switching Output (NC)	W	Trigger Input	AOK	Digital output OK
V	Contamination/Error Output (NO)	O	Analog Output	SY In	Synchronization In
ṽ	Contamination/Error Output (NC)	O-	Ground for the Analog Output	SY OUT	Synchronization OUT
E	Input (analog or digital)	BZ	Block Discharge	Out	Brightness output
T	Teach Input	AWV	Valve Output	M	Maintenance
Z	Time Delay (activation)	a	Valve Control Output +		
S	Shielding	b	Valve Control Output 0 V		
RxD	Interface Receive Path	SY	Synchronization		
TxD	Interface Send Path	E+	Receiver-Line		
RDY	Ready	S+	Emitter-Line		
GND	Ground	≡	Grounding		
CL	Clock	SnR	Switching Distance Reduction		
E/A	Output/Input programmable	Rx+/-	Ethernet Receive Path		
	IO-Link	Tx+/-	Ethernet Send Path		
PoE	Power over Ethernet	Bus	Interfaces-Bus A(+)/B(-)		
IN	Safety Input	La	Emitted Light disengageable		
OSSD	Safety Output	Mag	Magnet activation		
Signal	Signal Output	RES	Input confirmation		
Bl..D+/-	Ethernet Gigabit bidirect. data line (A-D)	EDM	Contactur Monitoring		
EN0..RS422	Encoder 0-pulse 0-0 (TTL)	ENAR5422	Encoder A/Ā (TTL)		
		ENBR5422	Encoder B/B̄ (TTL)		

Wire Colors according to DIN IEC 757

BK	Black
BN	Brown
RD	Red
OG	Orange
YE	Yellow
GN	Green
BU	Blue
VT	Violet
GY	Grey
WH	White
PK	Pink
GNYE	Green/Yellow

