

Reference Manual

BRD4543B



The EZR32HG family of Wireless MCUs deliver a high performance, low energy wireless solution integrated into a small form factor package.

By combining a high performance sub-GHz RF transceiver with an energy efficient 32-bit MCU, the family provides designers the ultimate in flexibility with a family of pin-compatible devices that scale from 32/64 kB of flash and support Silicon Labs EZRadio or EZRadioPRO transceivers. The ultra-low power operating modes and fast wake-up times of the Silicon Labs energy friendly 32-bit MCUs, combined with the low transmit and receive power consumption of the sub-GHz radio, result in a solution optimized for battery powered applications.

To develop and/or evaluate the EZR32 Happy Gecko the EZR32HG Radio Board can be connected to the Wireless Starter Kit Mainboard to get access to display, buttons and additional features from Expansion Boards.

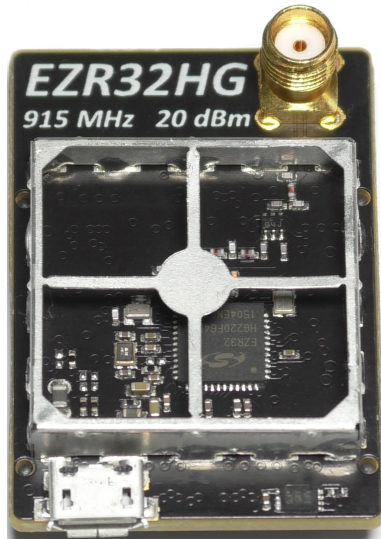

RADIO BOARD FEATURES

- Wireless MCU: EZR32HG320F64R68G
- CPU core: ARM Cortex-M0+
- Flash memory: 64 kB
- RAM: 8 kB
- Sub-GHz transceiver integrated in the Wireless MCU: EZRadioPRO
- Operation frequency: 915 MHz
- Transmit power: 20 dBm
- Single antenna connector both for transmit and receive
- Crystals for LFXO and HFXO: 32.768 kHz and 24 MHz.
- Crystal for RF: 30 MHz
- Full speed USB 2.0 (12 Mbps)

1. Introduction

The EZR32 Happy Gecko Radio Boards provide a development platform (together with the Wireless Starter Kit Mainboard) for the Silicon Labs EZR32 Happy Gecko Wireless Microcontrollers and serve as reference designs for the matching network of the RF interface.

The BRD4543B is designed to operate in the US FCC 902-928 MHz band, the RF matching network is optimized to operate in the 915 MHz band with 20 dBm output power.

To develop and/or evaluate the EZR32 Happy Gecko the BRD4543B Radio Board can be connected to the Wireless Starter Kit Mainboard to get access to display, buttons and additional features from Expansion Boards and also to evaluate the performance of the RF interface.

2. Radio Board Connector Pin Associations

The figure below shows the pin mapping on the connector to the radio pins and their function on the Wireless Starter Kit Mainboard.

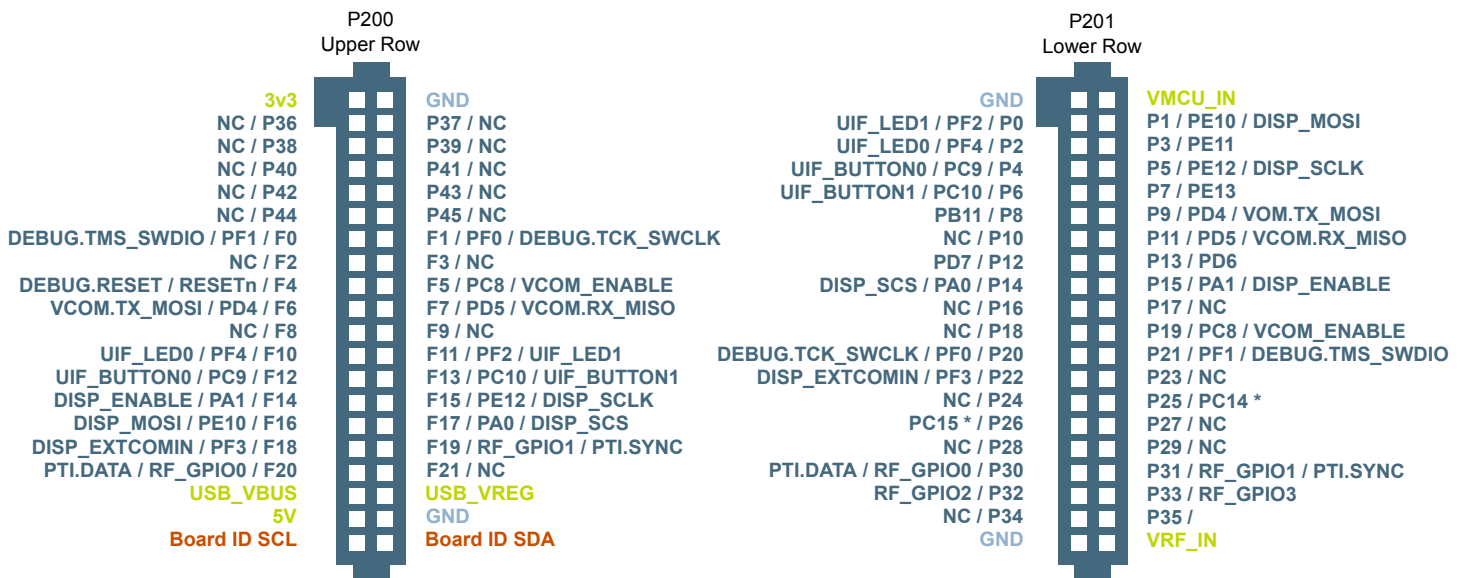

* Connection is not enabled by default on the Radio Board.

To enable 0 Ohm resistors should be mounted. See the schematic of the Radio Board.

Figure 2.1. BRD4543B Radio Board Connector Pin Mapping

3. Radio Board Block Description

The block diagram of the EZR32HG Radio Board is shown in the figure below. For the exact part numbers of the applied components refer to the BRD4543B BOM.

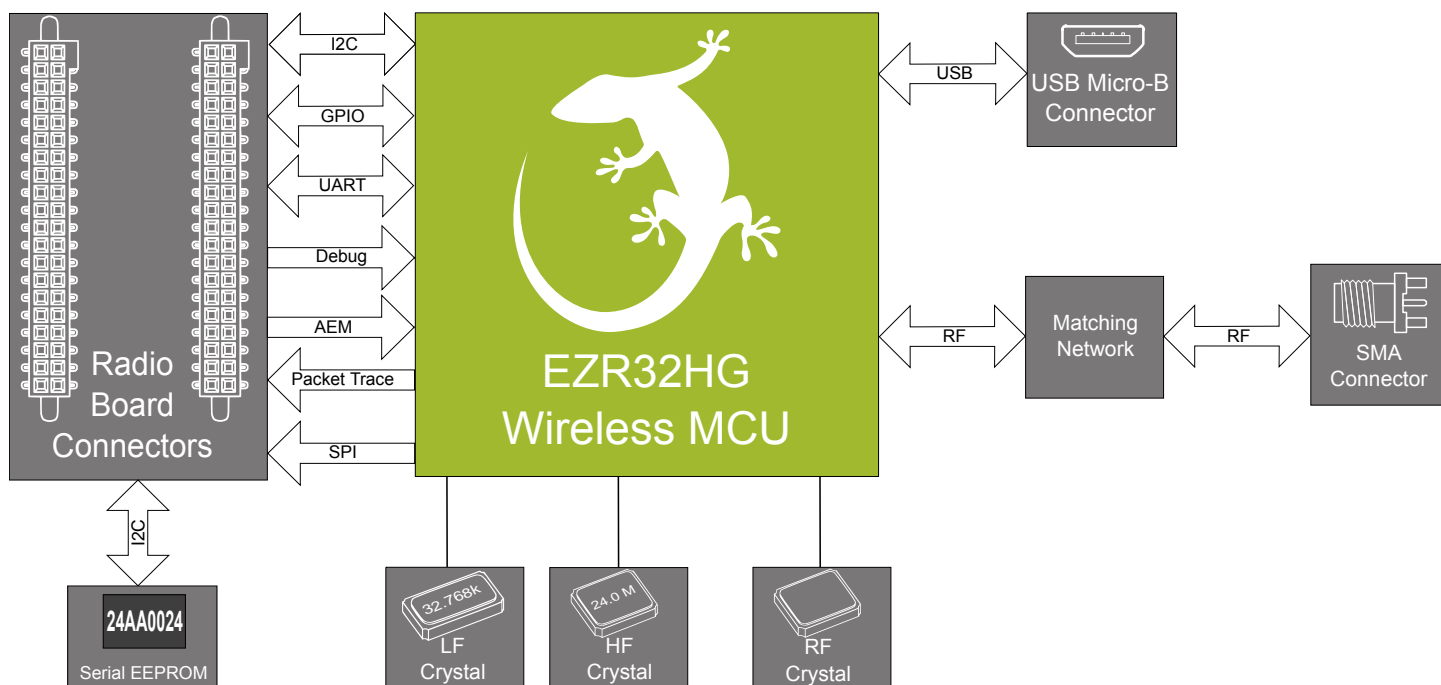

Figure 3.1. EZR32HG Radio Board Block Diagram

3.1 Wireless MCU

The BRD4543B EZR32 Happy Gecko Radio Board incorporates an EZR32HG320F64R68G Wireless Microcontroller featuring 32-bit Cortex-M0+ core, 64 kB of flash memory and 8 kB of RAM. For additional information on the EZR32HG320F64R68G, refer to the EZR32HG320 Data Sheet.

The EZR32HG320F64R68G is built using the Si4468, a high-performance, low-current transceiver that is part of Silicon Labs' EZRadio-PRO family. The Si4468 contains an integrated +20 dBm power amplifier that is capable of transmitting from -20 to +20 dBm. For a complete feature set and in-depth information on the transceiver, refer to the "Si4463/61/60-C High-Performance, Low-Current Transceiver" Data Sheet.

3.2 USB

The BRD4543B Radio Board incorporates a micro USB connector. The 3.3V USB regulator output is routed back to the WSTK through the Radio Board Connector so the Radio Board can supply power to the Wireless Starter Kit Mainboard.

For additional information on EZR32HG USB, refer to the EZR32HG320 Data Sheet.

3.3 RF Crystal Oscillator (RFXO)

The BRD4543B Radio Board has a 30 MHz crystal mounted. For more details on crystal or TCXO selection for the RF part of the EZR32 devices refer to "AN785: Crystal Selection Guide for the Si4x6x RF ICs".

3.4 LF Crystal Oscillator (LFXO)

The BRD4543B Radio Board has a 32.768 kHz crystal mounted. For safe startup two capacitors are also connected to the LFXTAL_N and LFXTAL_H pins. For details regarding the crystal configuration, the reader is referred to Application Note "AN0016: EFM32 Oscillator Design Consideration".

3.5 HF Crystal Oscillator (HFXO)

The BRD4543B Radio Board has a 24 MHz crystal mounted. For safe startup two capacitors are also connected to the HFXTAL_N and HFXTAL_H pins. For details regarding the crystal configuration, the reader is referred to Application Note "AN0016: EFM32 Oscillator Design Consideration".

3.6 RF Matching Network

The BRD4543B Radio Board includes a Class E type matching network with a so-called Switched matching configuration where the TX and RX sides are connected together with an additional RF switch, to be able to use one antenna both for transmitting and receiving. The component values were optimized for the 915 MHz band RF performance and current consumption with 20 dBm output power.

For more details on the matching network used on the BRD4543B see Chapter [4.1 Matching Network](#).

3.7 SMA Connector

To be able to perform conducted measurements or mount external antenna for radiated measurements, range tests etc., Silicon Labs added an SMA connector to the Radio Board. The connector allows an external 50 Ohm cable or antenna to be connected during design verification or testing.

3.8 Radio Board Connectors

Two dual-row, 0.05" pitch polarized connectors make up the EZR32HG Radio Board interface to the Wireless Starter Kit Mainboard.

For more information on the pin mapping between the EZR32HG320F64R68G and the Radio Board Connector refer to Chapter [2. Radio Board Connector Pin Associations](#).

4. RF Section

The BRD4543B Radio Board includes a Class E type TX matching network with the targeted output power of 20 dBm at 915 MHz.

The main advantage of the Class E matching types is their very high efficiency. They are proposed for applications where the current consumption is most critical, e.g., the typical total EZRadioPRO chip current with Class E type matching is ~75-90 mA at ~20 dBm (using the 20dBm PA output and assuming 3.3 V supply voltage).

The main disadvantage of the Class E type matches is the high supply voltage dependency (the power variation is proportional to the square of the supply voltage change: i.e. the decrease in power can be ~6 dB in the 1.8–3.8 V range) and the inaccurate nonlinear power steps. Also their current consumption and the peak voltage on the TX pin are sensitive to the termination impedance variation, and they usually require slightly higher order filtering and thus higher bill of materials cost.

The matching network is constructed with a so-called Switched configuration where the TX and RX sides are connected together with an additional RF switch, to be able to use one antenna both for transmitting and receiving. Careful design procedure was followed to ensure that the RX input circuitry does not load down the TX output path while in TX mode and that the TX output circuitry does not degrade receive performance while in RX mode.

For detailed explanation of the Class E type TX matching and the Switched configuration matching procedure the reader is referred to "AN648: Si4063/Si4463/64/67/68 TX Matching". For detailed description of the RX matching the reader is referred to "AN643: Si446x/Si4362 RX LNA Matching".

4.1 Matching Network

The matching network structure used on the BRD4543B Radio Board is shown in the figure below.

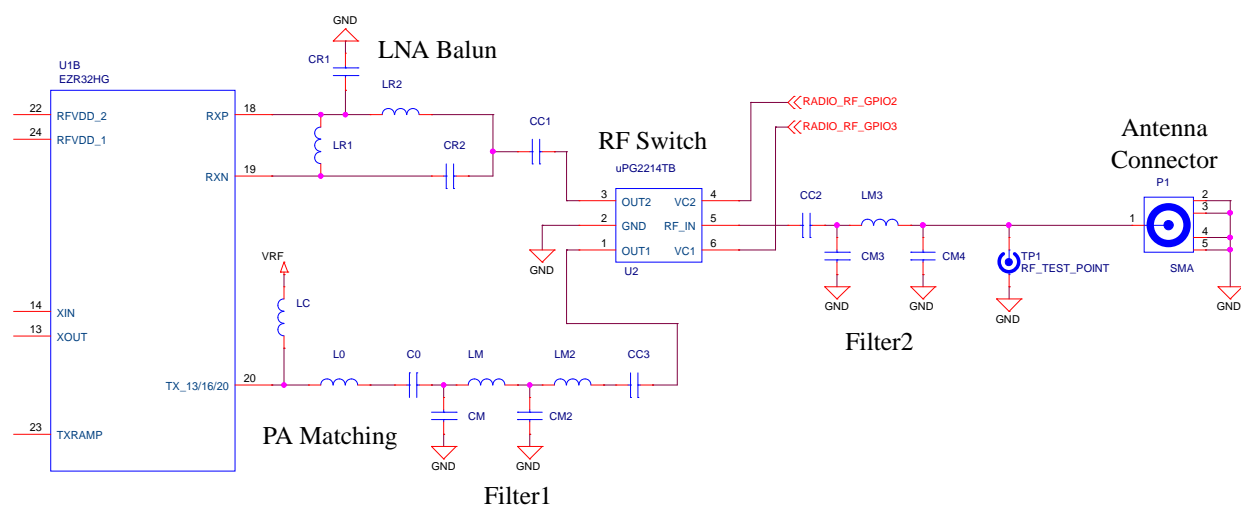

Figure 4.1. RF Section of the Schematic of the BRD4543B EZR32 Happy Gecko Radio Board

The component values were optimized for the 915 MHz band RF performance and current consumption with 20 dBm output power. The resulting component values with part numbers are listed in the table below.

Table 4.1. Bill of Materials for the BRD4543B RF Matching Network

Component name	Value	Manufacturer	Part Number
C0	20 pF	Murata	GRM1555C1H200J
CM	4.7 pF	Murata	GRM1555C1H4R7C
CM2	2.7 pF	Murata	GRM1555C1H2R7C
CM3	4.3 pF	Murata	GRM1555C1H4R3C
CM4	4.3 pF	Murata	GRM1555C1H4R3C
CR1	3.0 pF	Murata	GRM1555C1H3R0C
CR2	1.0 pF	Murata	GRM1555C1H1R0B
CC1	56 pF	Murata	GRM1555C1H560J
CC2	56 pF	Murata	GRM1555C1H560J
CC3	56 pF	Murata	GRM1555C1H560J
L0	11 nH	Coilcraft	0402HP-11NXJL
LC	120 nH	Coilcraft	0402HPH-R12XJL
LM	10 nH	Coilcraft	0402HP-10NXJL
LM2	10 nH	Coilcraft	0402HP-10NXJL
LM3	8.2 nH	Coilcraft	0402HP-8N2XJL
LR1	18 nH	Coilcraft	0402HP-18NXJL
LR2	22 nH	Coilcraft	0402HP-22NXJL

The Application Note "AN648: Si4063/Si4463/64/67/68 TX Matching" contains component values for reference matching networks which were developed for the EZRadioPRO Pico Boards. For the WSTK radio boards some fine-tuning of the component values may be necessary due to different parasitic effects (bonding wire, layout etc.). For optimized RF performance the component values listed in the table above may differ from the ones listed in the referred Application Note.

For the reader's specific application and board layout the adjustment of the final matching values might be necessary. The above component values should be used as starting points and the values modified slightly to zero-in on the best filter response and impedance match to 50 ohm. To minimize the differences due to different layout parasitics Silicon Labs recommends copying the layout of the RF section of the radio board as is. If that is not possible, refer to "AN629: Si4460/61/63/64/67/68 RF ICs Layout Design Guide" for layout design recommendations.

5. Mechanical Details

The BRD4543B EZR32 Happy Gecko Radio Board is illustrated in the figures below.

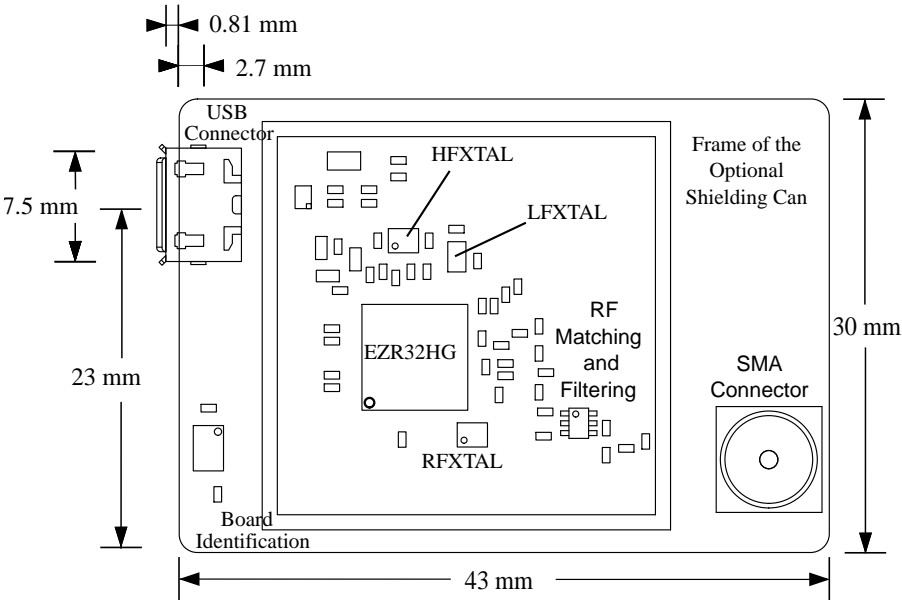

Figure 5.1. BRD4543B Top View

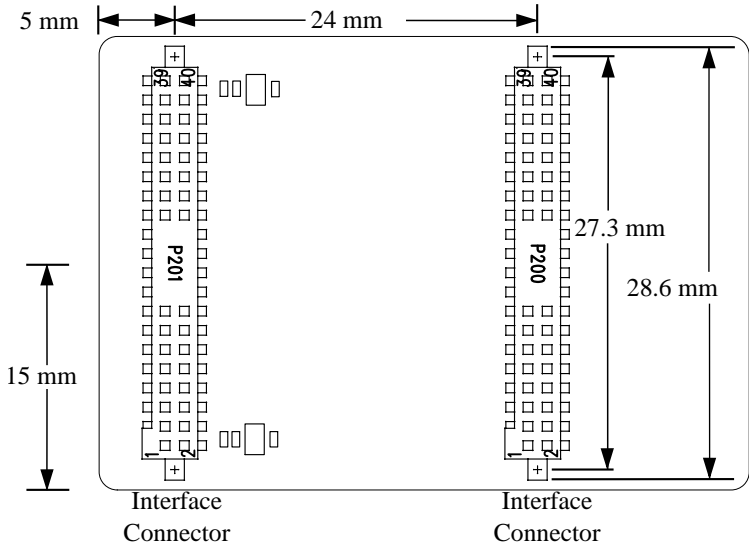

Figure 5.2. BRD4543B Bottom View

6. EMC compliance

The BRD4543B EZR32 Happy Gecko Radio Board is dedicated for operation in the US FCC 902-928 MHz band. The relevant FCC 15.247 regulation specifies the maximum allowed level of the fundamental power and spurious emissions.

In this document the compliance of the Radio Board fundamental and harmonic emissions will be investigated with 915 MHz fundamental frequency (harmonics are measured up to the 10th one).

6.1 FCC 15.247 Emission Limits for the 902-928 MHz Band

Based on FCC 15.247 the allowed maximum fundamental power for the 902-928 MHz band is 1 W (+30 dBm) for radiated measurements.

Note: Further in this document EIRP (Effective Isotropic Radiated Power) will be used for the comparison of the radiated limits and measurement results. The 1 W radiated limit is equivalent to +30 dBm EIRP.

Outside the allowed frequency bands FCC 15.247 specifies the maximum allowed spurious emission level to be 20 dB below the power of the fundamental, based on either a conducted or radiated measurement. In addition, radiated emissions which fall in the restricted bands defined in FCC 15.205(a) must also comply with the radiated emission limits specified in FCC 15.209(a). Above 960 MHz this is defined as 500 uW (-41.2 dBm EIRP).

In case of operating at 915 MHz the harmonics falling into restricted bands are the 3rd, 4th, 5th, 8th, 9th and 10th harmonics.

Note: The FCC restricted band limits are radiated limits only. Besides that, Silicon Labs applies those to the conducted spectrum i.e. it is assumed that in case of a custom board an antenna is used which has 0 dB gain at the fundamental and the harmonic frequencies. In that theoretical case, based on the conducted measurement, the compliance with the radiated limits can be estimated.

7. RF Performance

7.1 Measurement setup

The BRD4543B EZR32 Happy Gecko Radio Board was attached to a Wireless Starter Kit Mainboard (BRD4001 (Rev. A02)) and its transceiver was operated in continuous carrier transmission mode. The output power of the radio was set to 20 dBm (PA_PWR_LVL = 0x7F, PA_BIAS_CLKDUTY = 0x00 at VRF=3.3 V).

7.2 Conducted Power Measurements

In case of the conducted measurements the output power was measured by connecting the EZR32HG Radio Board directly to a Spectrum Analyzer (P/N: MS2692A) through its on-board SMA connector. At 20 dBm output power and 3.3 V supply voltage the measured typical current consumption of the RF section of the board is 90 mA.

A typical output spectrum is shown in the figure below.

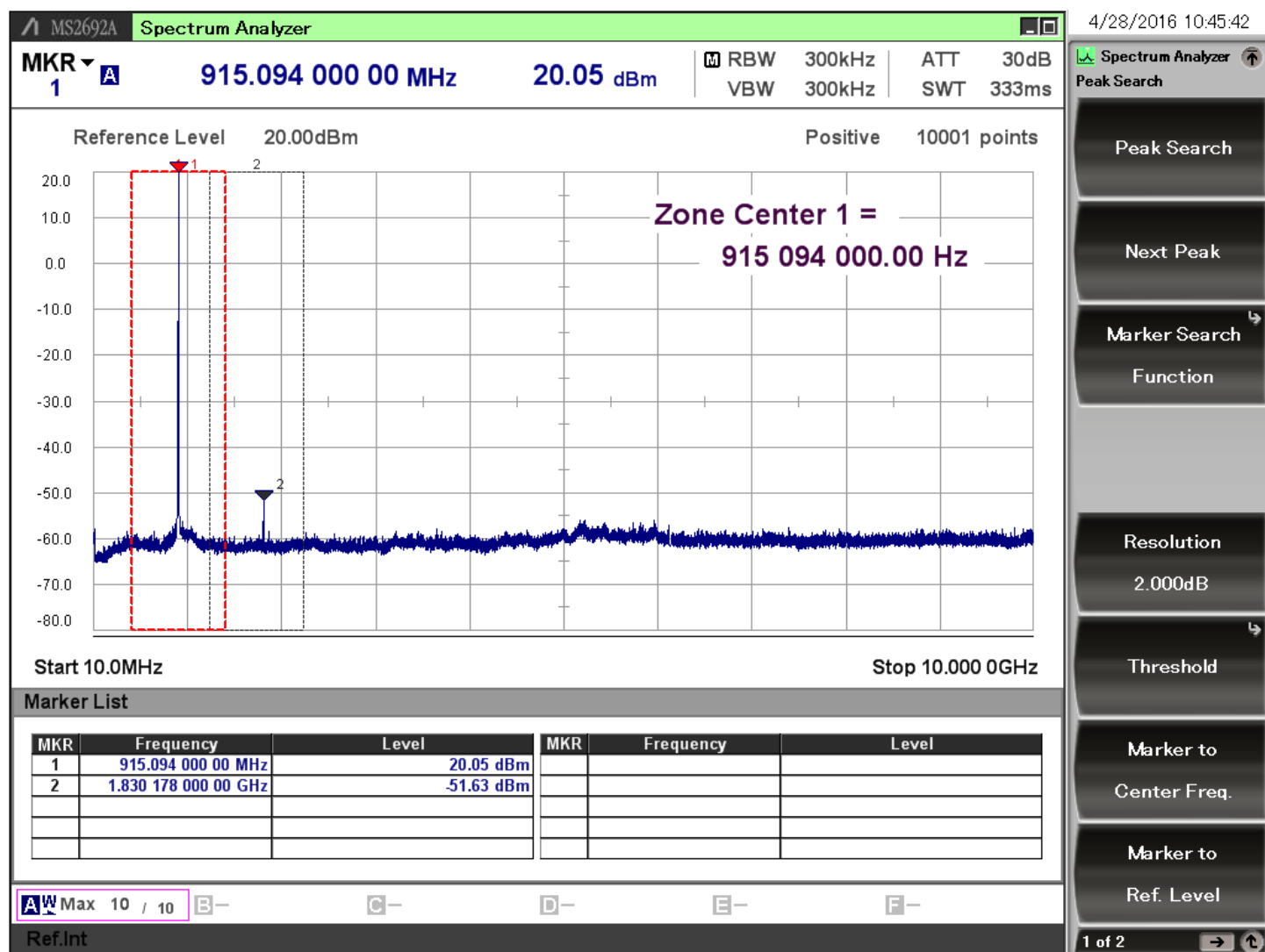

Figure 7.1. Typical Output Spectrum of the BRD4543B Radio Board

As it can be observed the unwanted emissions are under -50 dBm so the conducted performance is compliant with the -20 dBc limit specified by FCC 15.247 and also with the -41.2 dBm limit in the restricted bands.

Note: In practice commercially available whip antennas usually have ~0-2 dB gain at the fundamental and < 0 dB gain at the harmonic frequencies so if the conducted levels are compliant with the emission limits with small margin it is likely that the margin on the harmonics radiated by an external whip antenna will be higher. Unfortunately in most cases, the PCB radiation (from traces or and/or components) is stronger so using shielding, applying larger duty cycle correction (if allowed) or reduction of the fundamental power could be necessary.

7.3 Radiated Power Measurements

For radiated measurements an external whip antenna (P/N: ANT-916-CW-HWR-SMA) was used. The power supply for the board were two AA batteries (3 V). The batteries were connected to the Wireless Starter Kit Mainboard through its External Power Supply connector with minimal wire length to minimize the wire radiation.

The DUT was rotated in 360 degree with horizontal and vertical reference antenna polarizations in the XY, XZ and YZ cuts. The measurement axes are as shown in the figure below.

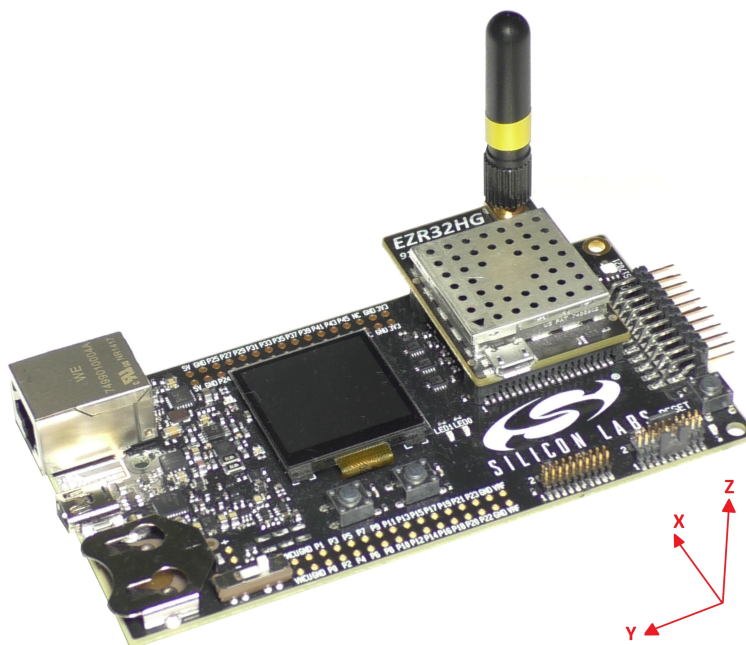

Figure 7.2. DUT: Radio Board with Wireless Starter Kit Mainboard (Illustration)

The measured radiated powers are shown in the table below.

Table 7.1. Maximums of the Measured Radiated Powers of the BRD4543B

915 MHz	EIRP [dBm]	Orientation	Margin [dB]	Limit in EIRP [dBm]
Fund	18.9	XY/V	11.1	30
2nd	-48.2	YZ/H	>20	-20dBc
3rd	-48.4	XZ/H	7.2	-41.2
4th	-48.6	XZ/H	7.4	-41.2
5th	-55.9	XZ/V	14.7	-41.2
6th	-55.6	XZ/H	>20	-20dBc
7th	Noise*	-/-	>20	-20dBc
8th	-48.4	XZ/V	7.2	-41.2
9th	-46.7	XZ/H	5.5	-41.2
10th	Noise*	-/-	>10	-41.2

* Signal level is below the Spectrum Analyzer noise floor.

As it can be observed the fundamental and all of the harmonics comply with the FCC 15.247 limits with large margin.

One may notice that the radiated harmonic levels, in general, are higher compared to the levels expected based on the conducted measurement. Investigations showed that this increase is due to the PCB radiations (components and PCB traces).

Note: The radiated measurement results presented in this document were recorded in an unlicensed antenna chamber. Also the radiated power levels may change depending on the actual application (PCB size, used antenna etc.) therefore the absolute levels and margins of the final application is recommended to be verified in a licensed EMC testhouse!

8. EMC Compliance Recommendations

8.1 Recommendations for FCC Compliance

As it was shown in the previous chapters the conducted performance of the BRD4543B EZR32 Happy Gecko Radio Board is compliant with the fundamental and harmonic emission limits of the FCC 15.247 regulation in the 915 MHz band with 20 dBm output power. For radiated compliance mounting a shielding can is required due to PCB radiation. With the mounted shielding can all of the harmonics are under the limits with large margins.

9. Document Revision History

Table 9.1. Document Revision History

Revision Number	Effective Date	Change Description
1.0	29.04.2016	Initial release

10. Board Revisions

Table 10.1. BRD4543B Radio Board Revisions

Radio Board Revision	Description
A00	Initial release

Table of Contents

1. Introduction	1
2. Radio Board Connector Pin Associations.	2
3. Radio Board Block Description	3
3.1 Wireless MCU	3
3.2 USB	3
3.3 RF Crystal Oscillator (RFXO).	3
3.4 LF Crystal Oscillator (LFXO)	3
3.5 HF Crystal Oscillator (HFXO).	4
3.6 RF Matching Network	4
3.7 SMA Connector	4
3.8 Radio Board Connectors	4
4. RF Section	5
4.1 Matching Network	5
5. Mechanical Details	7
6. EMC compliance	8
6.1 FCC 15.247 Emission Limits for the 902-928 MHz Band	8
7. RF Performance	9
7.1 Measurement setup	9
7.2 Conducted Power Measurements	9
7.3 Radiated Power Measurements	11
8. EMC Compliance Recommendations	13
8.1 Recommendations for FCC Compliance	13
9. Document Revision History	14
10. Board Revisions.	15
Table of Contents	16



Simplicity Studio

One-click access to MCU tools, documentation, software, source code libraries & more. Available for Windows, Mac and Linux!

www.silabs.com/simplicity



MCU Portfolio
www.silabs.com/mcu



SW/HW
www.silabs.com/simplicity



Quality
www.silabs.com/quality



Support and Community
community.silabs.com

Disclaimer

Silicon Laboratories intends to provide customers with the latest, accurate, and in-depth documentation of all peripherals and modules available for system and software implementers using or intending to use the Silicon Laboratories products. Characterization data, available modules and peripherals, memory sizes and memory addresses refer to each specific device, and "Typical" parameters provided can and do vary in different applications. Application examples described herein are for illustrative purposes only. Silicon Laboratories reserves the right to make changes without further notice and limitation to product information, specifications, and descriptions herein, and does not give warranties as to the accuracy or completeness of the included information. Silicon Laboratories shall have no liability for the consequences of use of the information supplied herein. This document does not imply or express copyright licenses granted hereunder to design or fabricate any integrated circuits. The products must not be used within any Life Support System without the specific written consent of Silicon Laboratories. A "Life Support System" is any product or system intended to support or sustain life and/or health, which, if it fails, can be reasonably expected to result in significant personal injury or death. Silicon Laboratories products are generally not intended for military applications. Silicon Laboratories products shall under no circumstances be used in weapons of mass destruction including (but not limited to) nuclear, biological or chemical weapons, or missiles capable of delivering such weapons.

Trademark Information

Silicon Laboratories Inc., Silicon Laboratories, Silicon Labs, SiLabs and the Silicon Labs logo, CMEMS®, EFM, EFM32, EFR, Energy Micro, Energy Micro logo and combinations thereof, "the world's most energy friendly microcontrollers", Ember®, EZLink®, EZMac®, EZRadio®, EZRadioPRO®, DSPLL®, ISOmodem®, Precision32®, ProSLIC®, SiPHY®, USBXpress® and others are trademarks or registered trademarks of Silicon Laboratories Inc. ARM, CORTEX, Cortex-M3 and THUMB are trademarks or registered trademarks of ARM Holdings. Keil is a registered trademark of ARM Limited. All other products or brand names mentioned herein are trademarks of their respective holders.



Silicon Laboratories Inc.
400 West Cesar Chavez
Austin, TX 78701
USA

<http://www.silabs.com>