

Datenblatt | Artikelnummer: 2106-5201

2-Leiter-Durchgangsklemme; mit Hebel und Drücker; 6 mm²; mit Prüföffnung; seitliche und mittige Beschriftung; für Tragschiene 35 x 15 und 35 x 7,5; Push-in CAGE CLAMP®

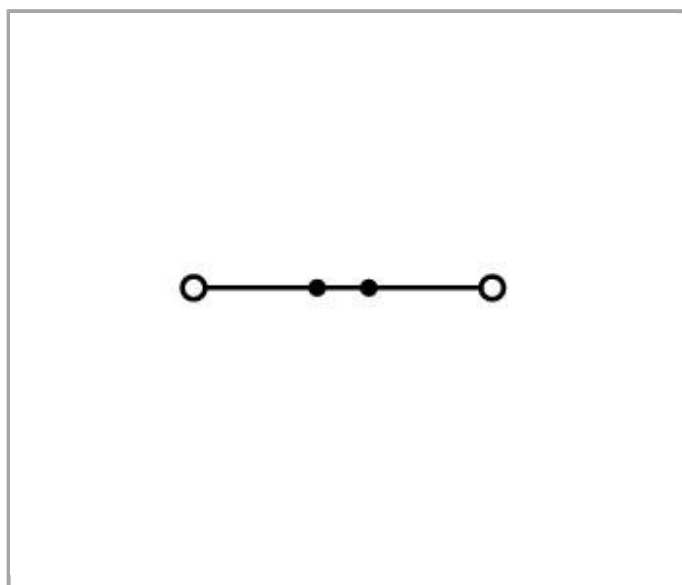

www.wago.com/2106-5201

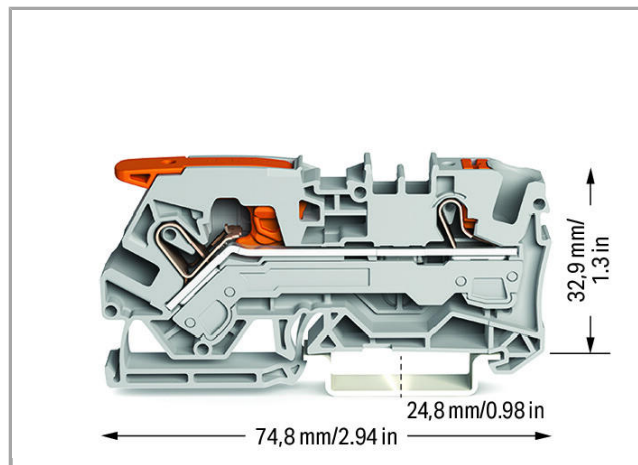
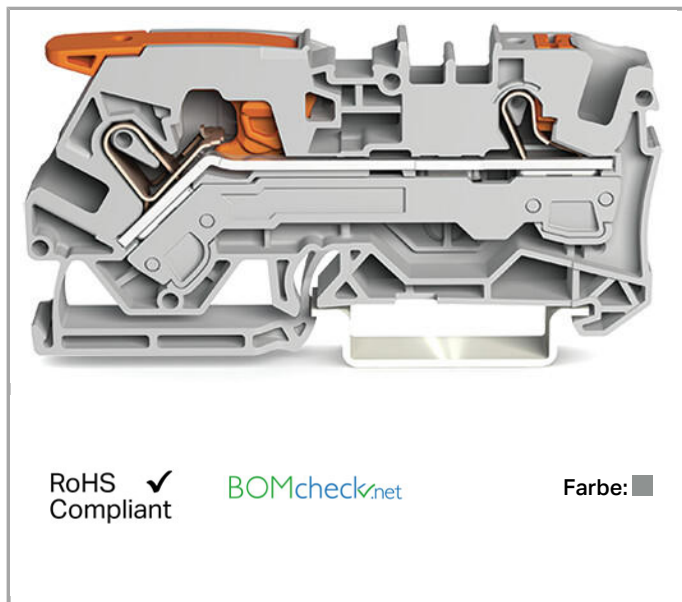

Daten

Elektrische Daten

Bemessungsdaten gemäß IEC/EN 60664-1

Bemessungsspannung (III / 3)	800 V
Bemessungsstoßspannung (III / 3)	8 kV
Bemessungsstrom	41 A

Bemessungsstrom 2

57 A

Anschlussdaten

Anschluss technik	Push-in CAGE CLAMP®
Betätigungsart	Push-in Hebel
Anschließbare Leiterwerkstoffe	Kupfer
Nennquerschnitt	6 mm ²
Eindrätiger Leiter	0,5 ... 10 mm ² / 20 ... 8 AWG
Eindrätiger Leiter; direkt steckbar	1 ... 10 mm ² / 14 ... 8 AWG
Feindrätiger Leiter	0,5 ... 10 mm ² / 20 ... 8 AWG
Abisolierlänge	13 ... 15 mm / 0.51 ... 0.59 inch
Gesamte Anzahl der Klemmstellen	2
Gesamte Anzahl der Potentiale	1
Anzahl der Ebenen	1
Verdrahtungsart	Frontverdrahtung
Betätigungsart 2	Push-in Drücker Betätigungswerkzeug
Leiterquerschnitte eindrätig	0.5 mm ²

Geometrische Daten

Breite	7,5 mm / 0.295 inch
Höhe ab Oberkante Tragschiene	32,9 mm / 1.295 inch
Tiefe	74,8 mm / 2.945 inch

Mechanische Daten

Bauform	horizontale Bauform
Montageart	Tragschiene 35
Beschriftungsebene	Mitten-/Seitliche Beschriftung

Werkstoffdaten

Farbe	grau
Isolierwerkstoff	Polyamid 66 (PA 66)
Brandlast	0 MJ
Gewicht	14.2 g

Kaufmännische Daten



Ursprungsland	DE
GTIN	4055143742450

Zolltarifnummer



8536901000

Zulassungen / Zertifikate

Ex-Zulassungen

Logo	Zulassung	Norm	Zertifikatsname
	AEx UL International Germany GmbH c/o Physikalisch Technische Bundesanstalt	UL 60079	E185892
	ATEX Physikalisch Technische Bundesanstalt	EN 60079-0	PTB 18 ATEX 1011 U
	IECEX Physikalisch Technische Bundesanstalt	IEC 60079-0	IECEX PTB 18.0018U

Länderspezifische Zulassungen

Logo	Zulassung	Norm	Zertifikatsname
	CCA DEKRA Certification B.V.	EN 60947	NTR NL 7678
	KEMA/KEUR DEKRA Certification B.V.	EN 60947	71-103226

UL-Zulassungen

Logo	Zulassung	Norm	Zertifikatsname
	UL Underwriters Laboratories Inc.	UL 1059	20181005- E45172

Passende Produkte

Abschlussplatte

	Art-Nr.: 2106-1291 Abschluss- und Zwischenplatte; 1 mm dick	www.wago.com/2106-1291
--	---	--

	Art-Nr.: 2106-1292 Abschluss- und Zwischenplatte; 1 mm dick	www.wago.com/2106-1292
--	---	--

Aderendhülse

	Art-Nr.: 216-208 Aderendhülse; Hülse für 6 mm ² / AWG 10; mit Kunststoffkragen; galvanisch verzinkt; Elektrolytkupfer; www.wago.com/216-208 gasdicht aufgecrimpt; gemäß DIN 46228, Teil 4/09.90
--	---

	Art-Nr.: 216-262 Aderendhülse; Hülse für 0,75 mm ² / AWG 18; mit Kunststoffkragen; galvanisch verzinkt; Elektrolytkupfer; www.wago.com/216-262 gasdicht aufgecrimpt; gemäß DIN 46228, Teil 4/09.90
--	--

	Art-Nr.: 216-263 Aderendhülse; Hülse für 1 mm ² / AWG 18; mit Kunststoffkragen; galvanisch verzinkt; Elektrolytkupfer; www.wago.com/216-263 gasdicht aufgecrimpt; gemäß DIN 46228, Teil 4/09.90
--	---

	Art-Nr.: 216-264 Aderendhülse; Hülse für 1,5 mm ² / AWG 16; mit Kunststoffkragen; galvanisch verzinkt; Elektrolytkupfer; www.wago.com/216-264 gasdicht aufgecrimpt; gemäß DIN 46228, Teil 4/09.90
--	---

	Art-Nr.: 216-266 Aderendhülse; Hülse für 2,5 mm ² / AWG 14; mit Kunststoffkragen; galvanisch verzinkt; Elektrolytkupfer; www.wago.com/216-266 gasdicht aufgecrimpt; gemäß DIN 46228, Teil 4/09.90
--	---

	Art-Nr.: 216-267 Aderendhülse; Hülse für 4 mm ² / AWG 12; mit Kunststoffkragen; galvanisch verzinkt; Elektrolytkupfer; www.wago.com/216-267 gasdicht aufgecrimpt; gemäß DIN 46228, Teil 4/09.90
--	---

Brücker

	Art-Nr.: 2006-402 Kammbrücker; isoliert; 2-fach; Nennstrom 41 A	www.wago.com/2006-402
--	---	--

	Art-Nr.: 2006-403 Kammbrücker; isoliert; 3-fach; Nennstrom 41 A	www.wago.com/2006-403
--	---	--

	Art-Nr.: 2006-404 Kammbrücker; isoliert; 4-fach; Nennstrom 41 A	www.wago.com/2006-404
--	---	--

	Art-Nr.: 2006-405 Kammbrücker; isoliert; 5-fach; Nennstrom 41 A	www.wago.com/2006-405
--	---	--

	Art-Nr.: 2006-405/011-000 Sternbrücker; isoliert; 3-fach (1-3-5); IN = IN Klemme	www.wago.com/2006-405/011-000
--	--	--

	Art-Nr.: 2006-433 Kammbrücker; isoliert; von 1 auf 3; Nennstrom 41 A	www.wago.com/2006-433
--	--	--

	Art-Nr.: 2006-434 Kammbrücker; isoliert; von 1 auf 4; Nennstrom 41 A	www.wago.com/2006-434
--	--	--

	Art-Nr.: 2006-435 Kammbrücker; isoliert; von 1 auf 5; Nennstrom 41 A	www.wago.com/2006-435
--	--	--

	Art-Nr.: 2006-499 Reduzierbrücker; isoliert; von 6/4 mm ² auf 4/2,5/1,5 mm ² ; Nennstrom 32 A	www.wago.com/2006-499
--	---	--

	Art-Nr.: 2016-499 Reduzierbrücker; isoliert; von 16/10 mm ² auf 10/6/4/2,5 mm ² ; Nennstrom 57 A	www.wago.com/2016-499
--	--	--



Art-Nr.: 210-103
 Drahtkettenbrücke; isoliert; 50 Anschlüsse

www.wago.com/210-103

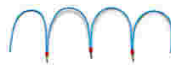

Art-Nr.: 210-123
 Drahtkettenbrücke; isoliert; 50 Anschlüsse

www.wago.com/210-123

Tragschiene



Art-Nr.: 210-112
 Stahltragschiene; 35 x 7,5 mm; 1 mm dick; 2 m lang; gelocht; entsprechend EN 60715; Lochbreite 25 mm; Lochabstand 36 mm www.wago.com/210-112



Art-Nr.: 210-113
 Stahltragschiene; 35 x 7,5 mm; 1 mm dick; 2 m lang; ungelocht; entsprechend EN 60715 www.wago.com/210-113



Art-Nr.: 210-114
 Stahltragschiene; 35 x 15 mm; 1,5 mm dick; 2 m lang; ungelocht; ähnlich EN 60715 www.wago.com/210-114



Art-Nr.: 210-115
 Stahltragschiene; 35 x 7,5 mm; 1 mm dick; 2 m lang; gelocht; entsprechend EN 60715; Lochbreite 18 mm; Lochabstand 25 mm www.wago.com/210-115



Art-Nr.: 210-118
 Stahltragschiene; 35 x 15 mm; 2,3 mm dick; 2 m lang; ungelocht; entsprechend EN 60715 www.wago.com/210-118



Art-Nr.: 210-196
 Aluminiumtragschiene; 35 x 8,2 mm; 1,6 mm dick; 2 m lang; ungelocht; ähnlich EN 60715 www.wago.com/210-196



Art-Nr.: 210-197
 Stahltragschiene; 35 x 15 mm; 1,5 mm dick; 2 m lang; gelocht; ähnlich EN 60715 www.wago.com/210-197



Art-Nr.: 210-198
 Kupfertragschiene; 35 x 15 mm; 2,3 mm dick; 2 m lang; ungelocht; entsprechend EN 60715 www.wago.com/210-198

Werkzeug



Art-Nr.: 210-721
 Betätigungswerkzeug mit teilisoliertem Schaft; Typ 3, Klinge (5,5 x 0,8) mm www.wago.com/210-721

Prüfen und Messen



Art-Nr.: 2006-511
 Modularer TOPJOB®S-Steckverbinder; anreihbar; für Brückerschlitze; 1-polig www.wago.com/2006-511



Art-Nr.: 2006-549
 Blindmodul; anreihbar; zum Überspringen von z. B. gebrückten Klemmen www.wago.com/2006-549



Art-Nr.: 2009-174
 Prüfadapter; für Prüfstecker Ø 4 mm; zur Prüfung von TOPJOB®S-Reihenklammern www.wago.com/2009-174



Art-Nr.: 2009-182
 Prüfgriff; für max. 2,5 mm²; für den werkzeuglosen Anschluss individueller Prüfleitungen von 0,08 mm - 2,5 mm www.wago.com/2009-182















Art-Nr.: 210-136
 Prüfstecker; Ø 2 mm; mit 500mm-Leitung www.wago.com/210-136

















Allgemeines Zubehör



Art-Nr.: 2006-191
 Verschlusskappe; Signalverteiler www.wago.com/2006-191

Beschriftungsmaterial

	Art-Nr.: 2009-110 Beschriftungsstreifen; auf Rolle; nicht dehnbar; unbedruckt; aufrastbar	www.wago.com/2009-110
	Art-Nr.: 2009-115 WMB-Inline; für Smart Printer; auf Rolle; dehnbar 5 - 5,2 mm; unbedruckt; aufrastbar	www.wago.com/2009-115
	Art-Nr.: 2009-115/000-002 WMB-Inline; für Smart Printer; auf Rolle; dehnbar 5 - 5,2 mm; unbedruckt; aufrastbar	www.wago.com/2009-115/000-002
	Art-Nr.: 2009-115/000-006 WMB-Inline; für smartPRINTER; auf Rolle; dehnbar 5 - 5,2 mm; unbedruckt; aufrastbar	www.wago.com/2009-115/000-006
	Art-Nr.: 2009-115/000-007 WMB-Inline; für Smart Printer; auf Rolle; dehnbar 5 - 5,2 mm; unbedruckt; aufrastbar	www.wago.com/2009-115/000-007
	Art-Nr.: 2009-115/000-012 WMB-Inline; für smartPRINTER; auf Rolle; dehnbar 5 - 5,2 mm; unbedruckt; aufrastbar	www.wago.com/2009-115/000-012
	Art-Nr.: 2009-115/000-017 WMB-Inline; für Smart Printer; auf Rolle; dehnbar 5 - 5,2 mm; unbedruckt; aufrastbar	www.wago.com/2009-115/000-017
	Art-Nr.: 2009-115/000-023 WMB-Inline; für Smart Printer; auf Rolle; dehnbar 5 - 5,2 mm; unbedruckt; aufrastbar	www.wago.com/2009-115/000-023
	Art-Nr.: 2009-115/000-024 WMB-Inline; für smartPRINTER; auf Rolle; dehnbar 5 - 5,2 mm; unbedruckt; aufrastbar	www.wago.com/2009-115/000-024
	Art-Nr.: 2009-145 Mini-WSB Inline; für Smart Printer; auf Rolle; dehnbar 5 - 5,2 mm; unbedruckt; aufrastbar	www.wago.com/2009-145
	Art-Nr.: 2009-145/000-002 Mini-WSB Inline; für Smart Printer; auf Rolle; dehnbar 5 - 5,2 mm; unbedruckt; aufrastbar	www.wago.com/2009-145/000-002
	Art-Nr.: 2009-145/000-005 Mini-WSB Inline; für Smart Printer; auf Rolle; dehnbar 5 - 5,2 mm; unbedruckt; aufrastbar	www.wago.com/2009-145/000-005
	Art-Nr.: 2009-145/000-006 Mini-WSB Inline; für Smart Printer; auf Rolle; dehnbar 5 - 5,2 mm; unbedruckt; aufrastbar	www.wago.com/2009-145/000-006
	Art-Nr.: 2009-145/000-007 Mini-WSB Inline; für Smart Printer; auf Rolle; dehnbar 5 - 5,2 mm; unbedruckt; aufrastbar	www.wago.com/2009-145/000-007
	Art-Nr.: 2009-145/000-012 Mini-WSB Inline; für Smart Printer; auf Rolle; dehnbar 5 - 5,2 mm; unbedruckt; aufrastbar	www.wago.com/2009-145/000-012

	<p>Art-Nr.: 2009-145/000-023 Mini-WSB Inline; für smartPRINTER; auf Rolle; dehnbar 5 - 5,2 mm; unbedruckt; aufrastbar</p>	www.wago.com/2009-145/000-023
	<p>Art-Nr.: 2009-145/000-024 Mini-WSB Inline; für Smart Printer; auf Rolle; dehnbar 5 - 5,2 mm; unbedruckt; aufrastbar</p>	www.wago.com/2009-145/000-024
	<p>Art-Nr.: 2009-191 Gruppenschildträger</p>	www.wago.com/2009-191
	<p>Art-Nr.: 2009-192 Gruppenschildträger</p>	www.wago.com/2009-192
	<p>Art-Nr.: 2009-193 Gruppenschildträger</p>	www.wago.com/2009-193
	<p>Art-Nr.: 2009-198 Adapter</p>	www.wago.com/2009-198
	<p>Art-Nr.: 248-501 Mini-WSB-Schnellbeschriftungssystem; unbedruckt; Schildchenbreite 5 mm; 10 Streifen à 10 Schilder pro Karte</p>	www.wago.com/248-501
	<p>Art-Nr.: 248-501/000-002 Mini-WSB-Beschriftungskarte; als Karte; nicht dehnbar; unbedruckt; aufrastbar</p>	www.wago.com/248-501/000-002
	<p>Art-Nr.: 248-501/000-005 Mini-WSB-Beschriftungskarte; als Karte; nicht dehnbar; unbedruckt; aufrastbar</p>	www.wago.com/248-501/000-005
	<p>Art-Nr.: 248-501/000-006 Mini-WSB-Beschriftungskarte; als Karte; nicht dehnbar; unbedruckt; aufrastbar</p>	www.wago.com/248-501/000-006
	<p>Art-Nr.: 248-501/000-007 Mini-WSB-Beschriftungskarte; als Karte; nicht dehnbar; unbedruckt; aufrastbar</p>	www.wago.com/248-501/000-007
	<p>Art-Nr.: 248-501/000-012 Mini-WSB-Beschriftungskarte; als Karte; nicht dehnbar; unbedruckt; aufrastbar</p>	www.wago.com/248-501/000-012
	<p>Art-Nr.: 248-501/000-017 Mini-WSB-Beschriftungskarte; als Karte; nicht dehnbar; unbedruckt; aufrastbar</p>	www.wago.com/248-501/000-017
	<p>Art-Nr.: 248-501/000-023 Mini-WSB-Beschriftungskarte; als Karte; nicht dehnbar; unbedruckt; aufrastbar</p>	www.wago.com/248-501/000-023
	<p>Art-Nr.: 248-501/000-024 Mini-WSB-Beschriftungskarte; als Karte; nicht dehnbar; unbedruckt; aufrastbar</p>	www.wago.com/248-501/000-024
	<p>Art-Nr.: 793-501 WMB-Beschriftungskarte; als Karte; nicht dehnbar; unbedruckt; aufrastbar</p>	www.wago.com/793-501



Art-Nr.: 793-501/000-002
WMB-Beschriftungskarte; als Karte; nicht dehnbar; unbedruckt; aufrastbar

www.wago.com/793-501/000-002



Art-Nr.: 793-501/000-005
WMB-Beschriftungskarte; als Karte; nicht dehnbar; unbedruckt; aufrastbar

www.wago.com/793-501/000-005



Art-Nr.: 793-501/000-006
WMB-Beschriftungskarte; als Karte; nicht dehnbar; unbedruckt; aufrastbar

www.wago.com/793-501/000-006



Art-Nr.: 793-501/000-007
WMB-Beschriftungskarte; als Karte; nicht dehnbar; unbedruckt; aufrastbar

www.wago.com/793-501/000-007



Art-Nr.: 793-501/000-012
WMB-Beschriftungskarte; als Karte; nicht dehnbar; unbedruckt; aufrastbar

www.wago.com/793-501/000-012



Art-Nr.: 793-501/000-017
WMB-Beschriftungskarte; als Karte; nicht dehnbar; unbedruckt; aufrastbar

www.wago.com/793-501/000-017



Art-Nr.: 793-501/000-023
WMB-Beschriftungskarte; als Karte; nicht dehnbar; unbedruckt; aufrastbar

www.wago.com/793-501/000-023



Art-Nr.: 793-501/000-024
WMB-Beschriftungskarte; als Karte; nicht dehnbar; unbedruckt; aufrastbar

www.wago.com/793-501/000-024



Art-Nr.: 793-5501
WMB-Beschriftungskarte; als Karte; für Klemmenbreite 5 - 17,5 mm; dehnbar 5 - 5,2 mm; unbedruckt; aufrastbar

www.wago.com/793-5501



Art-Nr.: 793-5501/000-002
WMB-Beschriftungskarte; als Karte; für Klemmenbreite 5 - 17,5 mm; dehnbar 5 - 5,2 mm; unbedruckt; aufrastbar

www.wago.com/793-5501/000-002



Art-Nr.: 793-5501/000-005
WMB-Beschriftungskarte; als Karte; dehnbar 5 - 5,2 mm; unbedruckt; aufrastbar

www.wago.com/793-5501/000-005



Art-Nr.: 793-5501/000-006
WMB-Beschriftungskarte; als Karte; dehnbar 5 - 5,2 mm; unbedruckt; aufrastbar

www.wago.com/793-5501/000-006



Art-Nr.: 793-5501/000-007
WMB-Beschriftungskarte; als Karte; dehnbar 5 - 5,2 mm; unbedruckt; aufrastbar

www.wago.com/793-5501/000-007



Art-Nr.: 793-5501/000-012
WMB-Beschriftungskarte; als Karte; dehnbar 5 - 5,2 mm; unbedruckt; aufrastbar

www.wago.com/793-5501/000-012



Art-Nr.: 793-5501/000-017
WMB-Beschriftungskarte; als Karte; dehnbar 5 - 5,2 mm; unbedruckt; aufrastbar

www.wago.com/793-5501/000-017



Art-Nr.: 793-5501/000-023

WMB-Beschriftungskarte; als Karte; dehnbar 5 - 5,2 mm; unbedruckt; aufrastbar

www.wago.com/793-5501/000-023



Art-Nr.: 793-5501/000-024

WMB-Beschriftungskarte; als Karte; dehnbar 5 - 5,2 mm; unbedruckt; aufrastbar

www.wago.com/793-5501/000-024

Downloads

Dokumentation

Ausschreibungstext

2106-5201		docx 15,0 kB	Download
-----------	--	-----------------	----------

Weitere Informationen

Technische Erläuterungen	Apr 3, 2019	pdf 2,1 MB	Download
--------------------------	-------------	---------------	----------

CAD/CAE - Smart Data

CAD Daten

3D Download 2106-5201		URL	Download
-----------------------	--	-----	----------

Änderungen vorbehalten.