

42563-8 ✓ ACTIVE

FASTON | FASTON 250

TE Internal #: 42563-8

Quick Disconnects, Receptacle, 12 – 10 AWG Wire Size, 3.31 – 5.26 mm<sup>2</sup> Wire Size, Mating Tab Width .25 in [6.35 mm], Flag, Phosphor Bronze, FASTON 250

[View on TE.com >](#)



Terminals & Splices > Quick Disconnects



Quick Disconnect Terminal Type: **Receptacle**

Wire Size: **3.31 – 5.26 mm<sup>2</sup>**

Mating Tab Width: **6.35 mm [ .25 in ]**

Mating Tab Thickness: **.81 mm [ .032 in ]**

## Features

### Product Type Features

Terminates To	Wire & Cable
Wire/Cable Type	Regular Wire
Wire Stop	No
Insertion Force	Normal
Sealable	No

### Configuration Features

Connection Capacity	Single
---------------------	--------

### Contact Features

Quick Disconnect Terminal Type	Receptacle
Mating Tab Width	6.35 mm [.25 in]
Mating Tab Thickness	.81 mm [.032 in]
Terminal Orientation	Flag
Contact Base Material	Phosphor Bronze
Terminal Plating Material	Tin
Crimp Type	Tab-Lok



Barrel Type	Open
-------------	------

### Mechanical Attachment

Mating Retention Type	Dimple
	.04 in

Extraction Force	24.5 Newton
------------------	-------------

Wire Insulation Support	With
-------------------------	------

### Dimensions

Accepts Wire Insulation Diameter Range	2.79 – 5.33 mm [.11 – .21 in]
--	-------------------------------

Receptacle Terminal Stock Thickness	.41 mm [.016 in]
-------------------------------------	------------------

Overall Length	17.02 mm [.67 in]
----------------	-------------------

Wire Size	3.31 – 5.26 mm <sup>2</sup>
-----------	-----------------------------

### Usage Conditions

Insulation Option	Uninsulated
-------------------	-------------

Operating Temperature Range	-40 – 110 °C [-40 – 230 °F]
-----------------------------	-----------------------------

### Industry Standards

CSA Certified	Yes
---------------	-----

UL Rating	Listed
-----------	--------

### Packaging Features

Packaging Quantity	3500
--------------------	------

Packaging Method	Strip/Reel
------------------	------------

### Other

Line	Premier
------	---------

### Product Compliance

[For compliance documentation, visit the product page on TE.com>](#)

EU RoHS Directive 2011/65/EU	Compliant
------------------------------	-----------

EU ELV Directive 2000/53/EC	Compliant
-----------------------------	-----------

China RoHS 2 Directive MIIT Order No 32, 2016	No Restricted Materials Above Threshold
---	---

EU REACH Regulation (EC) No. 1907/2006	Current ECHA Candidate List: JUNE 2022 (224) Candidate List Declared Against: JUNE 2022 (224) Does not contain REACH SVHC
--	---



Halogen Content	Low Halogen - Br, Cl, F, I < 900 ppm per homogenous material. Also BFR/CFR/PVC Free
Solder Process Capability	Not applicable for solder process capability







Product Compliance Disclaimer

This information is provided based on reasonable inquiry of our suppliers and represents our current actual knowledge based on the information they provided. This information is subject to change. The part numbers that TE has identified as EU RoHS compliant have a maximum concentration of 0.1% by weight in homogenous materials for lead, hexavalent chromium, mercury, PBB, PBDE, DBP, BBP, DEHP, DIBP, and 0.01% for cadmium, or qualify for an exemption to these limits as defined in the Annexes of Directive 2011/65/EU (RoHS2). Finished electrical and electronic equipment products will be CE marked as required by Directive 2011/65/EU. Components may not be CE marked. Additionally, the part numbers that TE has identified as EU ELV compliant have a maximum concentration of 0.1% by weight in homogenous materials for lead, hexavalent chromium, and mercury, and 0.01% for cadmium, or qualify for an exemption to these limits as defined in the Annexes of Directive 2000/53/EC (ELV). Regarding the REACH Regulation, the information TE provides on SVHC in articles for this part number is based on the latest European Chemicals Agency (ECHA) 'Guidance on requirements for substances in articles' posted at this URL: <https://echa.europa.eu/guidance-documents/guidance-on-reach>

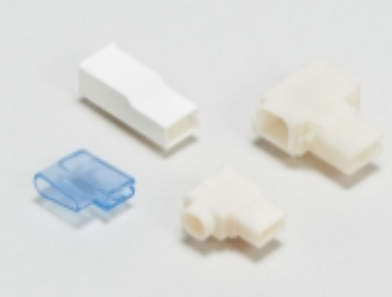
### Compatible Parts

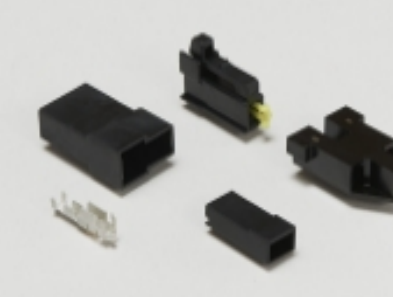
 <p>TE Part # 63617-1 250 FASTON FLAG REC 12-10 AWG BR</p>	 <p>TE Part # 61187-1 250 FASTON FLAG REC 12-10 AWG PHBZ</p>	 <p>TE Part # 1855521-1 HDM/FA/HB EMPO200TL220O LM CUT</p>	 <p>TE Part # 565505-2 STD HBEMPR200T220OK</p>
---	---	---	---

### Also in the Series | FASTON 250

 <p>Compression Connectors(4)</p>	 <p>Crimp Terminal Housings(141)</p>	 <p>Insertion &amp; Extraction Tools(6)</p>	 <p>Magnet Wire Terminals(1)</p>
 <p>PCB Terminals(144)</p>	 <p>Quick Disconnects(453)</p>	 <p>Splices(4)</p>	

## Customers Also Bought

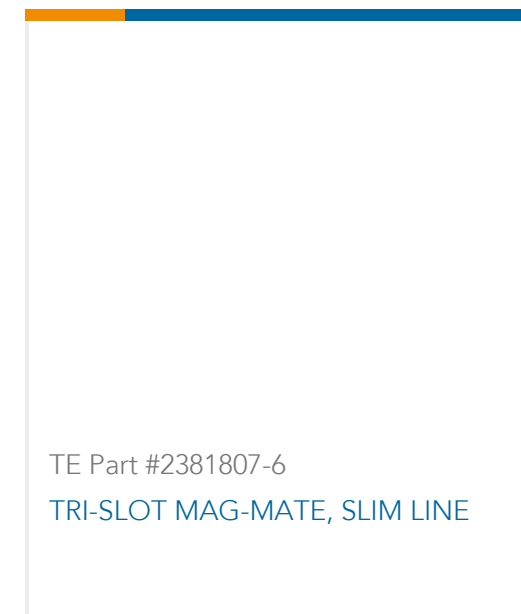
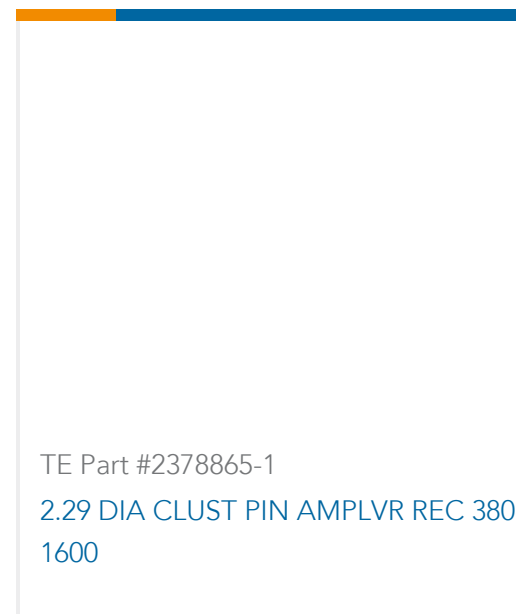
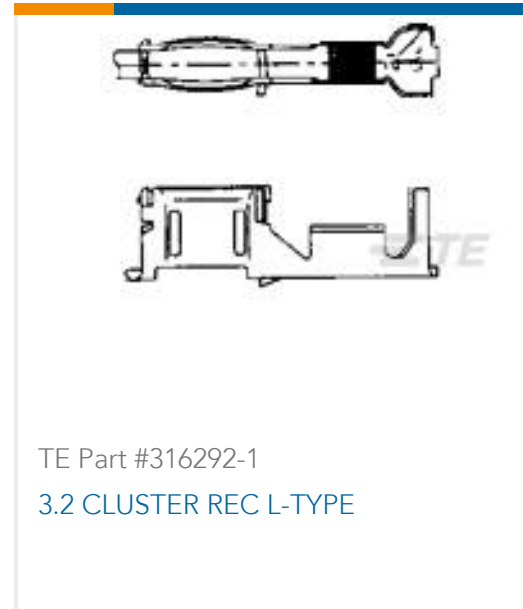

## Documents

### Product Drawings

[250 FASTON FLAG REC 12-10 AWG TPBZ](#)

English

### CAD Files

[3D PDF](#)

[3D](#)

[Customer View Model](#)

[ENG\\_CVM\\_CVM\\_42563-8\\_DA.2d\\_dxf.zip](#)

English

[Customer View Model](#)

[ENG\\_CVM\\_CVM\\_42563-8\\_DA.3d\\_igs.zip](#)

English

[Customer View Model](#)

[ENG\\_CVM\\_CVM\\_42563-8\\_DA.3d\\_stp.zip](#)

English

By downloading the CAD file I accept and agree to the [Terms and Conditions](#) of use.



### Datasheets & Catalog Pages

[82004 FASTON Terminals \(Insulated and Uninsulated\) Catalog - FASTON Receptacles Section](#)

English

---

### Product Specifications

[Application Specification](#)

English

---

### Product Environmental Compliance

[MD\\_42563-8\\_061320162255\\_dmtec](#)

English

[MD\\_42563-8\\_061320162255\\_dmtec](#)

English