

Specification sheet : SP-DSR-243

Firm : Distrelec Schweiz AG
 Address : Grabenstrasse 6
 Zip / City : 8606 NÄNIKON
 Customercode : 13996215 / DSR

TBS partnumber : **SP-DSR-243**
 Date : 27-1-2023
 Your partnumber :

Coiled cable dimensions

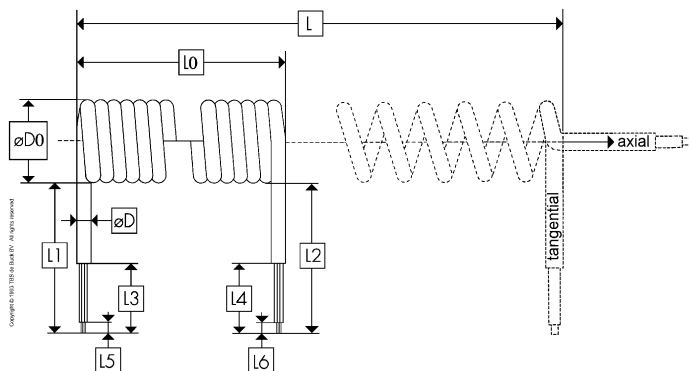

L=	2800 mm.	
L0=	700 mm.	
ØD=	13,8 mm.	
ØD0=	49,6 mm.	
L1=	200 mm.	tangential
L2=	200 mm.	tangential
L3=	mm.	
L4=	mm.	
L5=	mm.	
L6=	mm.	

Weight: ± 1,51 kg / pc

Cable specification

Cable type : 07BQ-F 7G1,50 mm² TB28 FLEX
 Stranding : 84x0,15 mm tinned copper wires
 Conductor insulation : EPR/EPDM
 Conductor colours : black numbered + yellow/green
 Overall sheath : PUR
 Colour : black (semi-glossy)
 Temperature range : -25 °C to +70 °C



Photographs are for illustrative purposes only

Tolerances ± 10% (dimensions and quantities)

Attention: Coiled cables, power cords and (cable)assemblies are customized products, specifically manufactured and supplied upon order. Therefore these products cannot be returned or exchanged in any way. Offer is non-committal, fixed price for up to 2 weeks, subjected to prior sale, subjected to technical changes, especially changes in measurement and construction. All our offers, orders granted to us and (project) contracts/agreements with us are subjected to the METAALUNIE TERMS AND CONDITIONS only. These terms and conditions have been filed at the Registry of the Rotterdam District Court.

TBS de Buck B.V.
 De Slof 2 5107 RJ Dongen
 The Netherlands
 V.A.T.-nr.: NL 8059.10.888.B01

HR Eindhoven nr.: 18048791
 Rabobank Tilburg nr.: 0304.1314.07
 IBAN code : NL39 RABO 0304 1314 07
 BIC code : RABONL2U

Phone : +31 (0) 162 523 436
 E-mail : sales@the-best-solution.com
 Internet : www.the-best-solution.com