



Product information GO 6 WF schwarz/black

Industrial Connecting Solutions:Rectangular Connectors:DIN VDE 0627 / IEC 61984 Connectors (G serie):Cable socket:GO 6 WF schwarz/black

<https://e-catalog.hirschmann.com:443/link/57078-24228-256261-24347-24348-36955/en/conf/ulistate>

Name	GO 6 WF schwarz/black
	
	Cable socket with PG 7 cable gland and solder contacts
Delivery informations	
Availability	available
Product description	
Description	Cable socket with PG 7 cable gland and solder contacts
Type	GO 6 WF schwarz/black
Order No.	932 447-100
Type of contact	forked spring
Number of contacts	6
Cable gland	PG 7
Conductor size	0.14 - 0.5 mm ²
Standard	DIN VDE 0627 / IEC 61984
Housing Color	black
Technical data	
Rated voltage	AC/DC 50 V
Rated current	6 A
Contact resistance	<= 4 mOhm
Type of termination	solder
Suitable cables	4 mm to 7.5 mm
Material	
Contact surface material	Sn
Contact bearer material	PA
Housing material	PA
Environmental conditions	
Protection class (IEC 60529)	IP 65
Pollution severity	3
Temperature range	-40 °C to +90 °C
Inflammability class	
Housing	94 V-1
Contact bearer	94 V-1
Packing unit	
Packaging unit	100 pieces
Scope of delivery and accessories	
Scope of delivery	1 cable socket with PG 7 cable gland, 1 central screw M 3 x 20, 1 gasket, not assembled, in polythene bag
Accessories to order separately	can be plugged into GO 6 UM, GO 6 FAV M



HIRSCHMANN

A BELDEN BRAND

Industrial Connecting Solutions:Rectangular Connectors:DIN VDE 0627 / IEC 61984 Connectors (G serie):Cable socket:GO 6 WF schwarz/black

<https://e-catalog.hirschmann.com:443/link/57078-24228-256261-24347-24348-36955/en/conf/ui/state>

Picture

Drawing

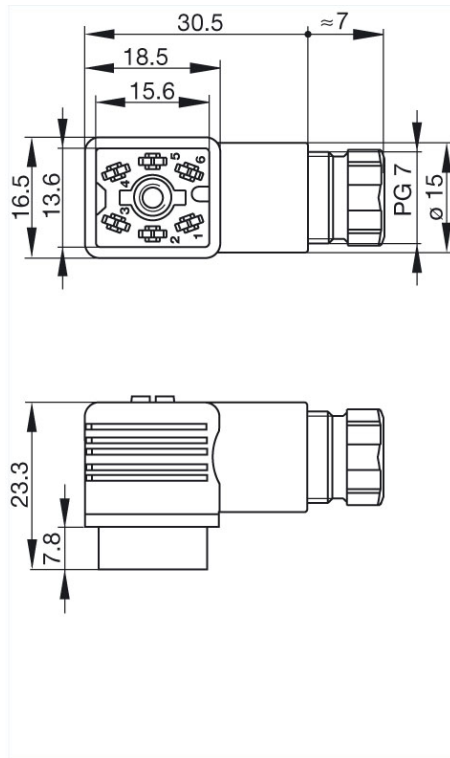

Belden Deutschland GmbH

Im Gewerbepark 2
58579 Schalksmühle
Germany
Phone: +49 7127/14-1806
E-Mail: icos-sales@belden.com

The information published in the websites has been compiled as carefully as possible. It is subject to alteration without notice in technical as well as in price-related/commercial respect. The complete information and data were available on user documentation. Mandatory information can only be obtained by a concrete query.