





Rocker switch

Rating	10(4)A 250V~ 	Mounting Hole
	16A 125V AC 	
	10A 250V AC 	
	10A 28VDC 	
Contact Resistance	50m ohm Max.	 <p>Panel Thickness 2.0~3.0 mm</p> <p>Panel Thickness 0.7~3.0 mm</p>
Insulation Resistance	DC 500V 100M ohm Min.	
Dielectric Strength	AC 1500V 1 minute	
Operation Temperature	-20°~85°	
Switch Function	2P SPST (ON)-OFF	



*Material
 Frame: Nylon#66,Black
 Actuator: Nylon#66,Black
 Terminal: Copper alloy,Silver plated

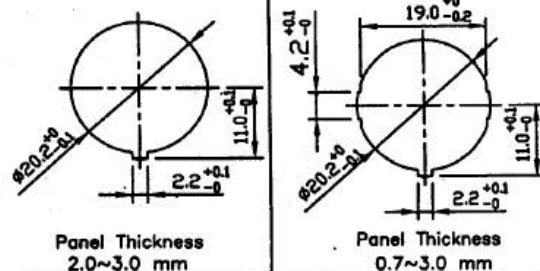
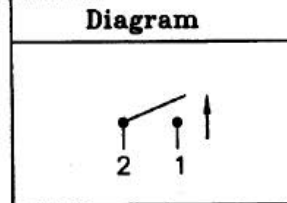
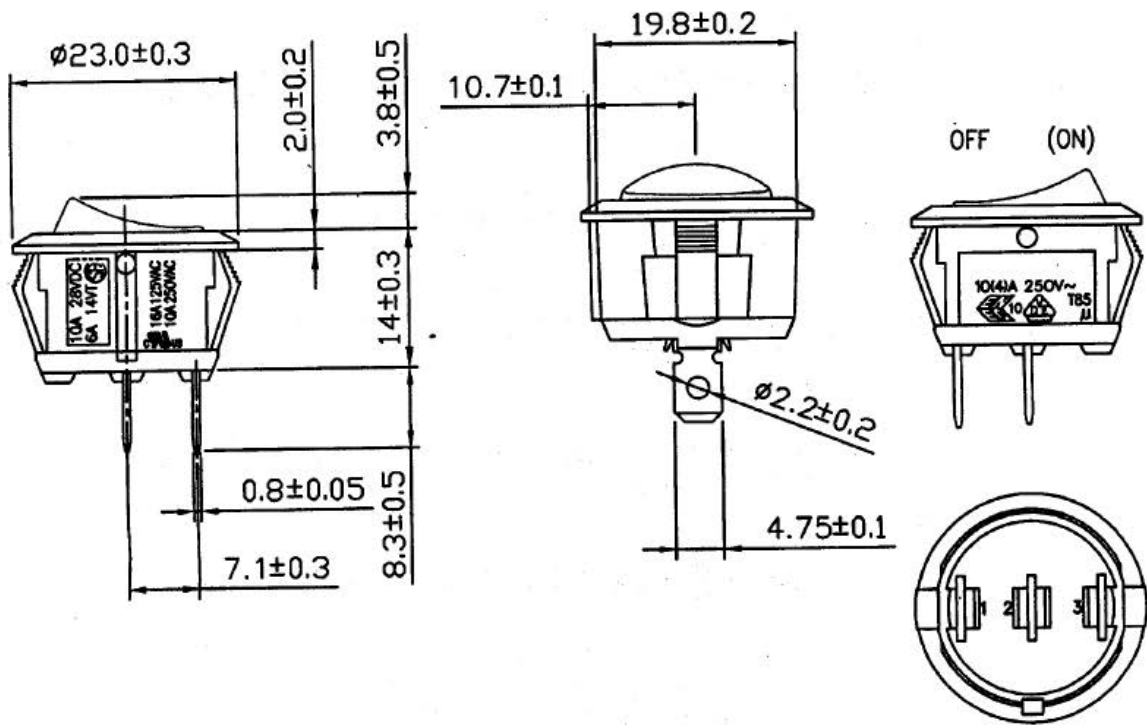
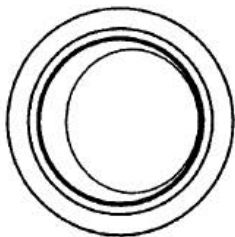

Unit: mm

This is a publication by Conrad Electronic SE, Klaus-Conrad-Str. 1, D-92240 Hirschau (www.conrad.com).
 All rights including translation reserved. Reproduction by any method, e.g. photocopy, microfilming, or the capture in electronic data processing systems require the prior written approval by the editor. Reprinting, also in part, is prohibited. This publication represents the technical status at the time of printing.