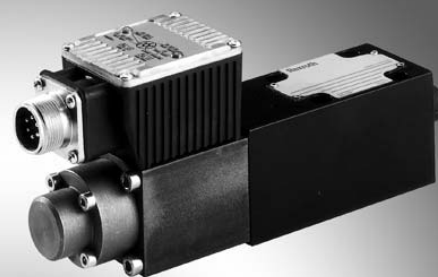

Proportional pressure relief valve, pilot operated

RE 29158/04.05
Replaces: 11.02

1/12

Types (Z)DBE and (Z)DBEE

Size 6
Component series 1X
Maximum operating pressure 315 bar
Maximum flow 30 L/min

H/A 3598/93

Table of contents

Contents	Page
Features	1
Ordering code	2
Preferred types	2
Symbols	3
Function, section	3, 4
Technical data	5, 6
Control electronics	6, 7
Electrical connection, cable socket	6
Characteristic curves	8, 9
Unit dimensions	10, 11

Features

- Valve for limiting a system pressure
- Operation by proportional solenoid
- For subplate mounting or sandwich plate design:
 - Position of ports to DIN 24340 (without locating bore) and ISO 4401 (with locating bore)
 - Subplates to data sheet RE 45052 (separate order, see page 10 and 11)
- Valve and control electronics from a single source
- External control electronics for types DBE and ZDBE:
 - Analogue amplifier type VT-VSPA1-1 in Euro-card format (separate order), see page 6
 - Digital amplifier type VT-VSPD-1 in Euro-card format (separate order), see page 6
 - Analogue amplifier of modular design type VT 11131 (separate order), see page 6
- Integrated electronics (OBE) on types DBEE and ZDBEE:
 - Low manufacturing tolerances for the command value/pressure characteristic curve
 - Up and down ramps can be adjusted independently of each other

Ordering code

	DBE		6		-1X/		G24		*
--	-----	--	---	--	------	--	-----	--	---

Subplate mounting = **No code**
Sandwich plate = **Z**

Proportional pressure relief valve

For external control electronics = **No code**
With integrated electronics (OBE) = **E**

Size 6 = **6**

Subplate mounting = **No code**
Sandwich plate P → T = **VP**

Position of cable socket for type ZDBE

Position of housing with electronics (OBE) for type ZDBEE

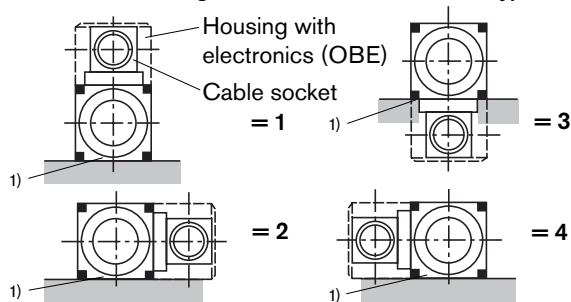

Component series 10 to 19 = **1X**
(10 to 19: unchanged installation and connection dimensions)

Max. set pressure

Pressure stage 50 bar = **50**
Pressure stage 100 bar = **100**
Pressure stage 200 bar = **200**
Pressure stage 315 bar = **315**

Further details
in clear text

Seal material

M = NBR seals,
suitable for mineral oil
(HL, HLP) to DIN 51524
V = FKM seals,
suitable for
phosphate esters

Electrical connection

for DBE; ZDBE:

K4 = **Without** cable socket,
with component plug to
DIN EN 175301-803
Cable socket- separate
order, see page 6

for DBEE; ZDBEE:

K31 = **Without** cable socket,
with component plug to
DIN EN 175201-804
Cable socket- separate
order, see page 6

Supply voltage of electronics

G24 = 24 V DC

No code = Internal pilot oil drain (recommen-
dation: subplate mounting up to $q_{Vmax} = 15$ L/min)

Y = External pilot oil drain
(possible only with subplate mounting)

Preferred types

Type DBEE

Type	Material no.
DBEE 6-1X/50YG24K31M	R900954432
DBEE 6-1X/100YG24K31M	R900919359
DBEE 6-1X/200YG24K31M	R900954433
DBEE 6-1X/315YG24K31M	R900546987

Type ZDBEE

Type	Material no.
ZDBEE 6 VP2-1X/50G24K31M	R900954434
ZDBEE 6 VP2-1X/100G24K31M	R900954435
ZDBEE 6 VP2-1X/200G24K31M	R900954436
ZDBEE 6 VP2-1X/315G24K31M	R900954437

Further preferred types and standard components
can be found in the EPS (standard price list).

Symbols (for sandwich plate symbol: ① = component side, ② = plate side)

Type DBE 6...

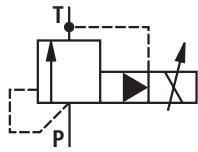

Type DBE 6...Y..

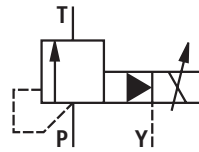

Type ZDBE 6 VP...

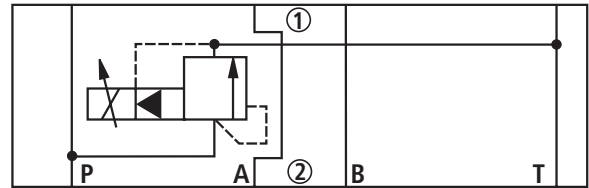

Type DBEE 6...

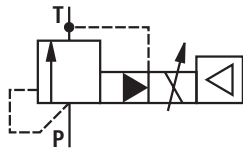

Type DBEE 6...Y..

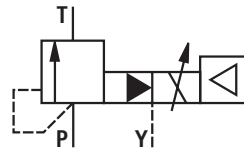

Type ZDBEE 6 VP...

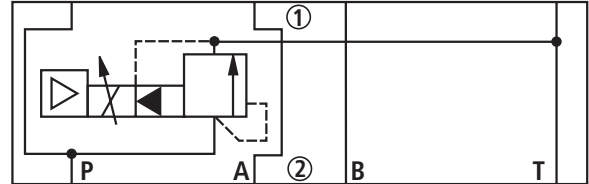

Function, section

Types DBE and ZDBE

Proportional pressure relief valves of types DBE and ZDBE are operated by means of a proportional solenoid. These valves are used to limit a system pressure. With these valves it is possible to infinitely adjust the system pressure to be limited in relation to the electrical command value.

These valves basically consist of a proportional solenoid (1), housing (2), valve insert (3), spool (4) and pilot poppet (8).

The proportional solenoid proportionally converts the electrical current into a mechanical force. An increase in the current intensity causes a corresponding rise in the magnetic force.

The solenoid armature chamber is filled with hydraulic fluid and is pressure-balanced.

The system pressure is adjusted by the proportional solenoid (1) in relation to the command value. Pressure applied by the system in port P acts on the right hand side of the spool (4). At the same time, the system pressure acts via the pilot line (6), which is fitted with an orifice (5), on the spring-loaded side of the spool (4).

Via a further orifice (7) the system pressure acts on the pilot poppet (8) against the force of the proportional solenoid (1). Once the system pressure has reached the pre-set value, the pilot poppet (8) lifts from its seat. Depending on the model, pilot oil can now drain externally via port A (Y) or internally into the tank, which results in a limitation of the pressure on the spring-loaded side of the spool (4). If the system pressure continues to rise slightly, then the higher pressure on the right hand side of the spool pushes the spool to the left into control position P to T.

At a minimum control current - corresponds to a command value of zero - the minimum settable pressure will be set.

Note!

To ensure optimum function, the valve must be bled during commissioning:

- Remove bleed screw (9),
- pour hydraulic fluid into the open threaded hole, item 9,
- when no more bubbles appear, re-fit screw, item 9.
- The tank should be prevented from draining. Where installation conditions allow, a pre-load valve should be installed (pre-load pressure approx. 2 bar).

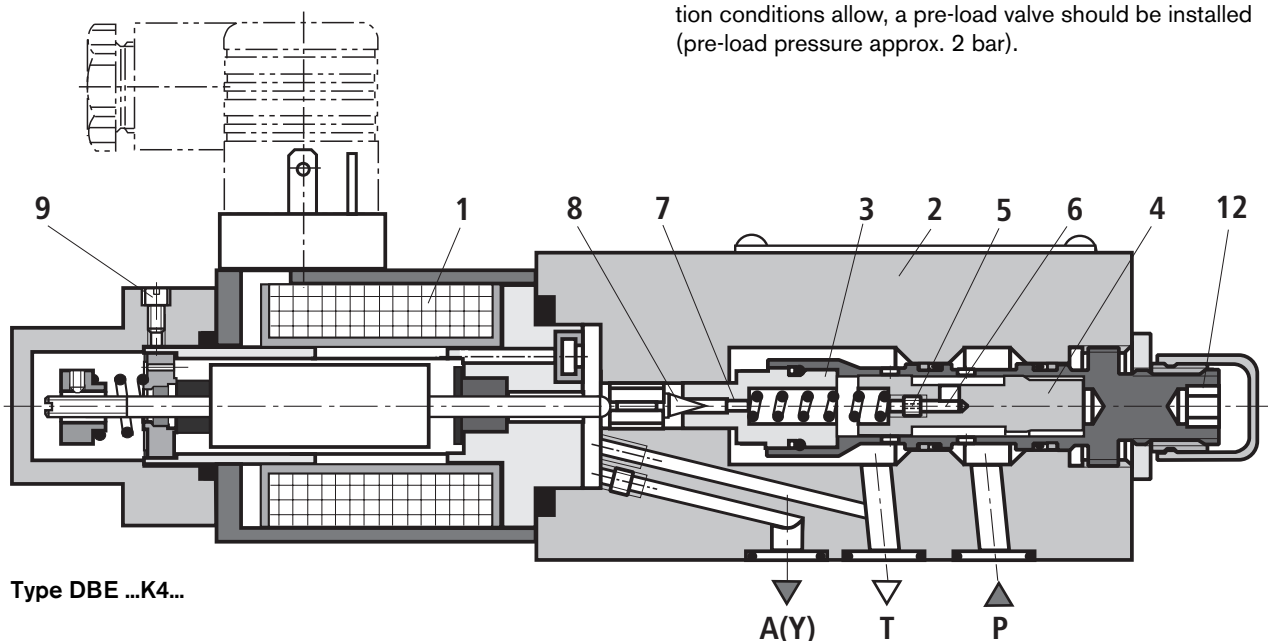

Type DBE ...K4...

Function, section

Types DBEE ...K31... and ZDBEE ...K31... – with integrated electronics (OBE)

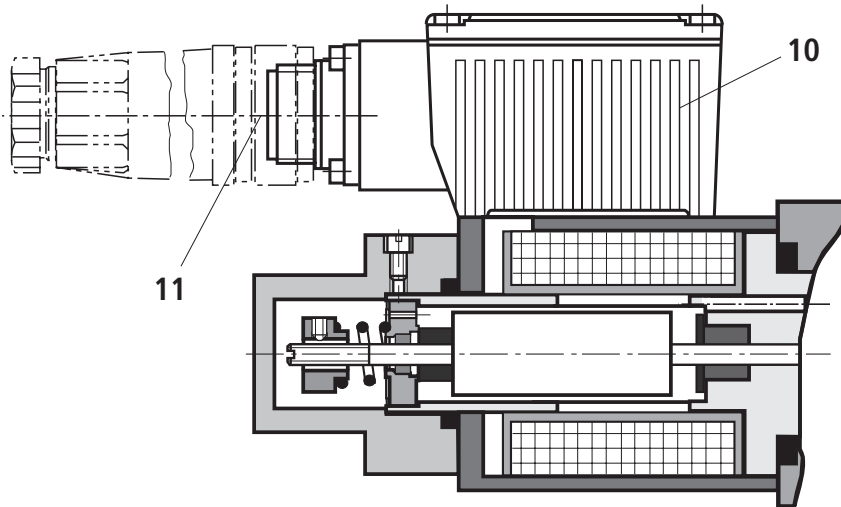

In terms of function and design, these valves correspond to types DBE and ZDBE. An additional housing (10) is fitted on the proportional solenoid which accommodates the integrated electronics (OBE). Supply and command value voltages are connected to the cable socket (11).

The command value/pressure characteristic curve (zero point at the valve insert, see page 3, item 12, and the gradient on the I_{max} potentiometer (R30) in the electronics) is factory pre-set with minor manufacturing tolerances.

The ramp time for pressure build-up and pressure reduction can be adjusted independently of each other using two potentiometers.

For further information about the integrated electronics, see page 7.

Technical data (for applications outside these parameters, please consult us!)**General**

Weight	– DBE and ZDBE	kg	2.4
	– DBEE and ZDBEE	kg	2.5
Installation orientation			Optional
Storage temperature range			°C – 20 to + 80
Ambient temperature range	– DBE and ZDBE	°C	– 20 to + 70
	– DBEE and ZDBEE	°C	– 20 to + 50

Hydraulic (measured with HLP 46; $\vartheta_{oil} = 40\text{ °C} \pm 5\text{ °C}$)

Max. operating pressure	– Port P; P1 – P2 A1 – A2; B1 – B2	bar	315
	– Port T	bar	50
Max. set pressure	– Pressure stage 50 bar	bar	50
	– Pressure stage 100 bar	bar	100
	– Pressure stage 200 bar	bar	200
	– Pressure stage 315 bar	bar	315
Min. set pressure at command value 0			bar See characteristic curve on page 9
Return flow pressure in port A; with external pilot oil drain (Y)			Separate at zero pressure to tank
Pilot oil flow		L/min	0.6 to 1.2
Max. flow		L/min	30
Hydraulic fluid			Mineral oil (HL, HLP) to DIN 51524. Further hydraulic fluids on enquiry!
Hydraulic fluid temperature range			°C – 20 to + 80
Viscosity range			mm ² /s 15 to 380
Max. permissible degree of contamination of the hydraulic fluid - cleanliness class to ISO 4406 (c)			Class 20/18/15 ¹⁾
Hysteresis		%	± 1.5 of max. set pressure
Repeatability		%	< ± 2 of max. set pressure
Linearity		%	± 3.5 of max. set pressure
Tolerance of the command value/pressure curve, referred to the hysteresis curve, increasing pressure	– DBE and ZDBE	%	± 2.5 of max. set pressure
	– DBEE and ZDBEE	%	± 1.5 of max. set pressure
Step response $T_u + T_g$	10 % → 90 %	ms	approx. 80
	90 % → 10 %	ms	approx. 50

] depends on system

¹⁾ The cleanliness classes specified for components must be adhered to in hydraulic systems. Effective filtration prevents malfunction and, at the same time, increases the service life of components.

For the selection of filters, see data sheets RE 50070, RE 50076, RE 50081, RE 50086 and RE 50088.

Technical data (for applications outside these parameters, please consult us!)**Electrical**

Supply voltage	V	24 DC
Min. control current	mA	100
Max. control current	mA	1600
Coil resistance	– Cold value at 20° C	Ω 5.4
	– Max. hot value	Ω 7.8
Duty cycle	%	100
Electrical connection	– DBE and ZDBE	With component plug to DIN EN 175301-803 Cable socket to DIN EN 175301-803 ²⁾
	– DBEE and ZDBEE	With component plug to DIN EN 175201-804 Cable socket to DIN EN 175201-804 ²⁾
Type of protection of the valve to EN 60529		IP 65 with cable socket mounted and locked

Control electronics

– For DBEE and ZDBEE		Integrated in the valve, see page 7
– For DBE and ZDBE		
Amplifier in Euro-card format (separate order)	analogue	VT-VSPA1-1 according to data sheet RE 30111
	digital	VT-VSPD-1 according to data sheet RE 30123
Amplifier of modular design (separate order)	analogue	VT 11131 according to data sheet RE 29865

²⁾ Separate order, see below

 **Note:** For details regarding **environment simulation testing** in the fields of EMC (electromagnetic compatibility),

climate and mechanical stress, see RE 29158-U (declaration on environmental compatibility).

Electrical connection, cable sockets (nominal dimensions in mm)

For types DBE and ZDBE – for external control electronics

Cable socket to DIN EN 175301-803

Separate order: Material no. **R901017011**

Connection to component plug

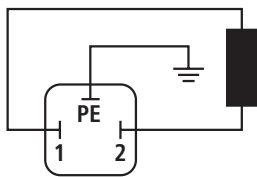

Connection to cable socket

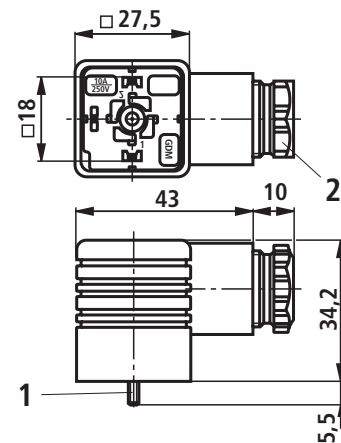
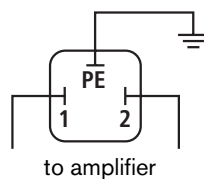

1 Fixing screw M3

Tightening torque $M_T = 0.5 \text{ Nm}$

For types DBEE and ZDBEE – with integrated electronics (OBE)

Cable socket to DIN EN 175201-804

Separate order: Material no. **R900021267** (version made of plastic)

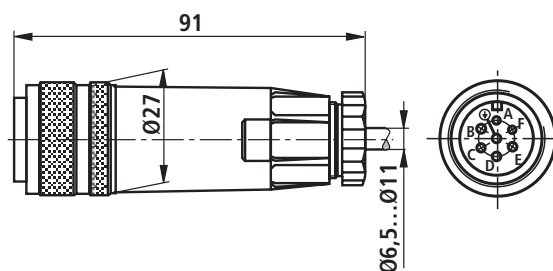

For the pin assignment, see block circuit diagram on page 7

Integrated electronics (OBE) for types DBEE, ZDBEE

Function

The integrated electronics is controlled via the two differential amplifier connections D and E.

The ramp generator generates from a command value step change (0 to 10 V or 10 to 0 V) a delayed rise or drop in the solenoid current. The rise time of the solenoid current can be adjusted by means of potentiometer R14, the drop time by means of potentiometer R13.

The maximum ramp time of 5 s is only possible over the entire command value range. With smaller command value changes the ramp time shortens accordingly.

The command value/solenoid current characteristic curve is matched to the valve by the characteristic curve generator, so that non-linearities in the hydraulics can be compensated for and hence a linear command value/pressure characteristic curve is obtained.

The current regulator controls the solenoid current independently of the solenoid coil resistance.

The gradient of the command value/current characteristic curve, and hence also the gradient of the command value/pressure characteristic curve of the proportional pressure valve may be altered using potentiometer R30.

Potentiometer R43 is used to adjust the biasing current. This setting should not be altered. If necessary, the zero point of the command value/pressure characteristic curve can be adjusted at the valve seat.

The power stage of the electronics for controlling the proportional solenoid is a chopper amplifier. It is pulse-width-modulated with a clock frequency of 300 Hz.

The solenoid current can be measured at the two measurement sockets MP1 and MP2. A voltage drop of 0.352 V at the measurement resistor corresponds to a solenoid current of 1.6 A.

Block circuit diagram / pin assignment of integrated electronics

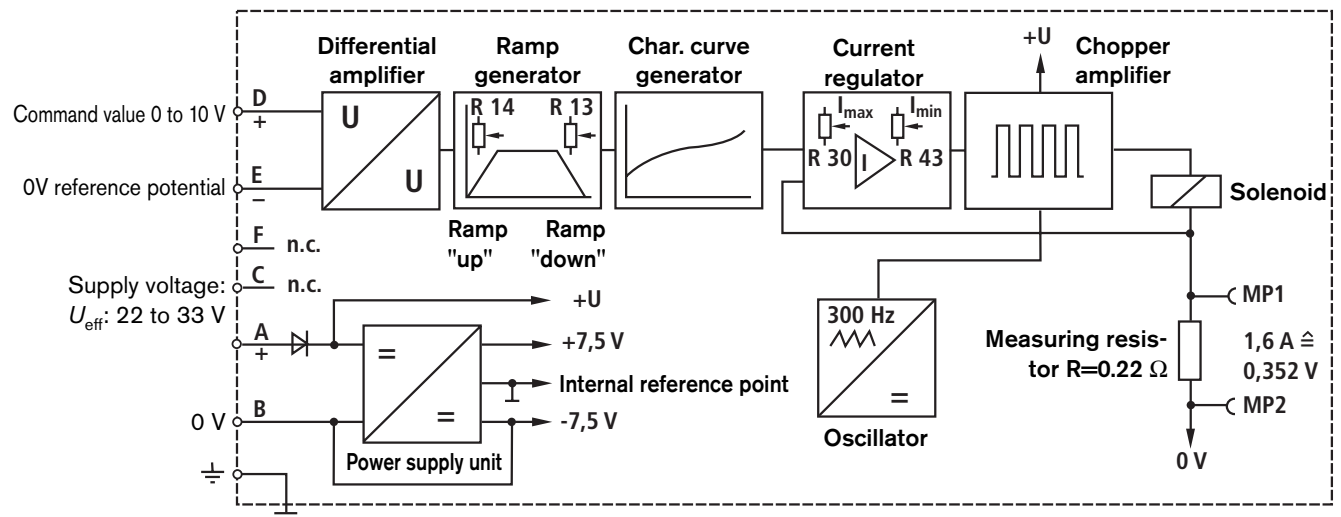

Supply voltage

Power supply unit with rectifier

Single phase rectification or three phase bridge: $U_{\text{eff}} = 22$ to 33 V

Residual ripple content at power supply unit: $< 5\%$

Output current: $I_{\text{eff}} = \text{max. } 1.4$ A

Supply cable:

- Recommended: 5-core 0.75 or 1 mm² with PE conductor and shield
- Outside diameter 6.5 to 11 mm
- Shield to 0 V supply voltage
- Max. permissible length 100 m

The minimum supply voltage of the power supply unit depends on the length of the supply cable (see diagram).

For lengths > 50 m a capacitor of 2200 μF must be installed near the valve in the supply line.

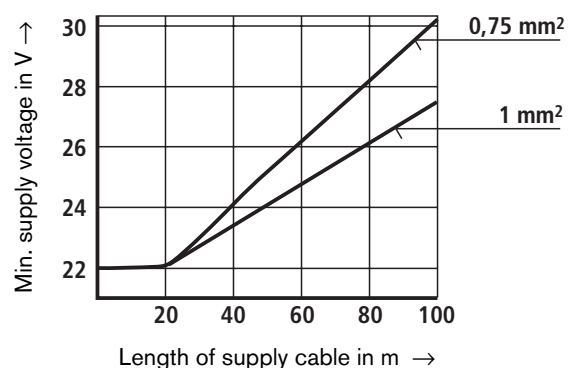

Characteristic curves (measured with HLP 46; $\vartheta_{oil} = 40 \text{ }^\circ\text{C} \pm 5 \text{ }^\circ\text{C}$)

Pressure in port P or P2 in dependence upon the command value ($q_v = 5 \text{ L/min}$)

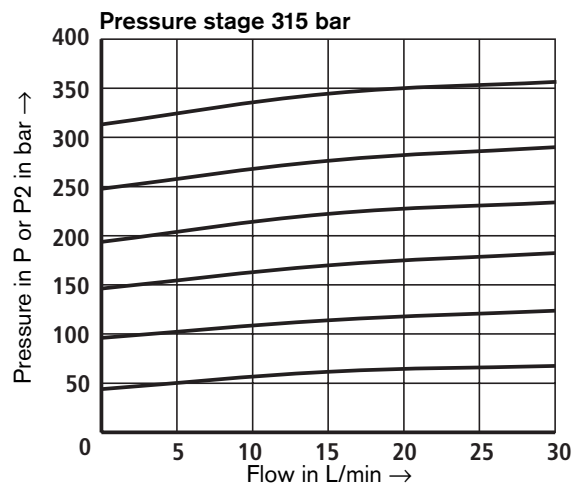
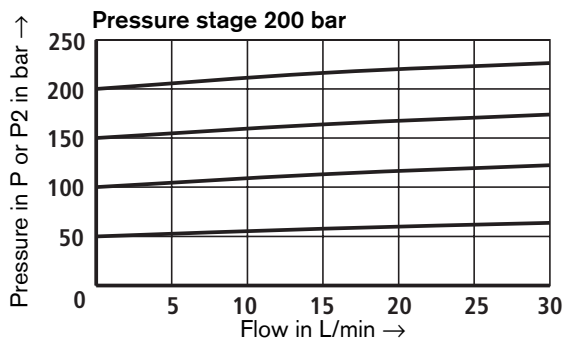
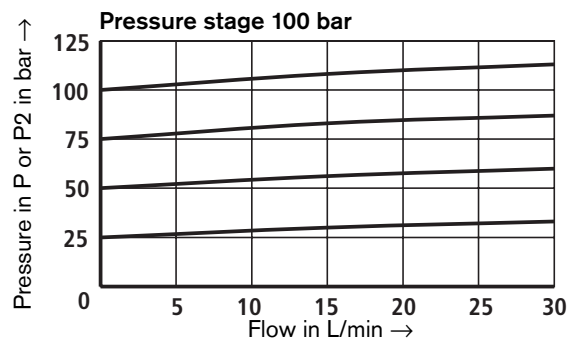
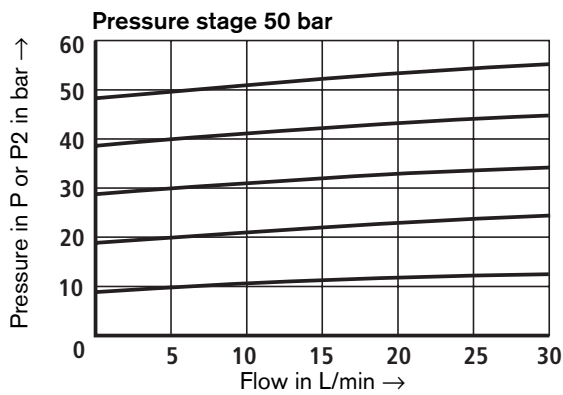
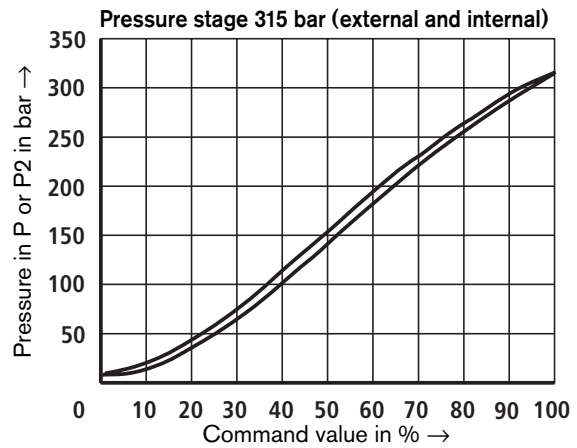
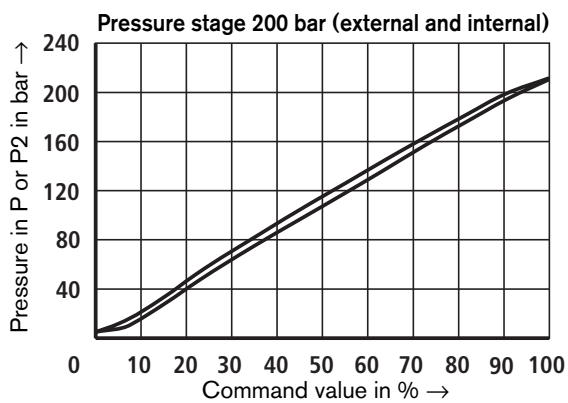
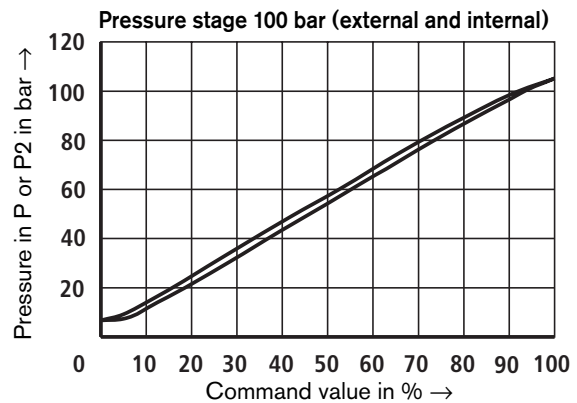
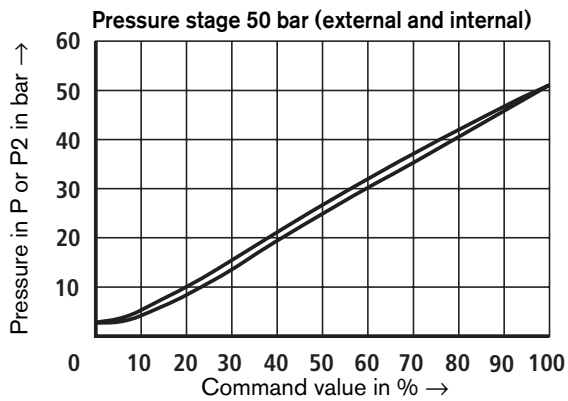

The characteristic curves were measured without backpressure in port A (external pilot oil drain) and T (internal pilot oil drain). With internal pilot oil drain the pressure in P or P2 increases by the output pressure present in port T.

Characteristic curves (measured with HLP 46; $\vartheta_{oil} = 40 \text{ }^\circ\text{C} \pm 5 \text{ }^\circ\text{C}$)

Min. set pressure in port P or P2 at command value 0.

Pilot oil drain ----- internal - - - external

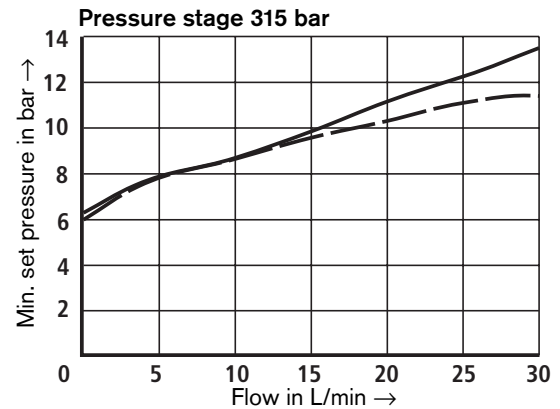
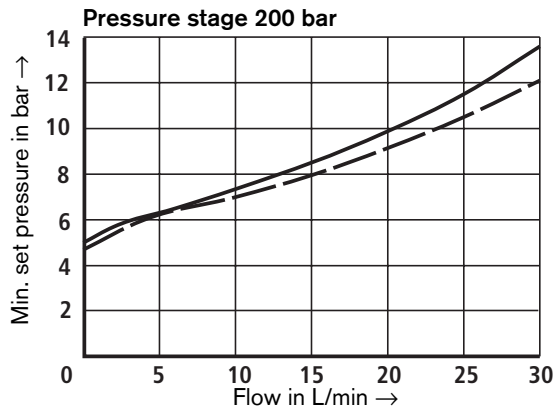
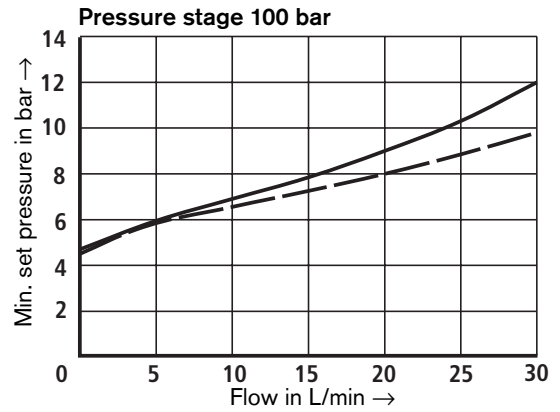
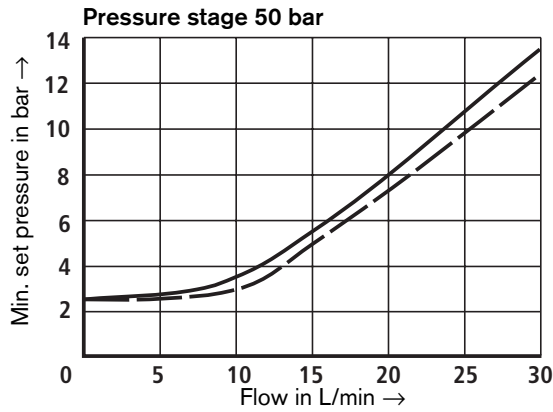

The characteristic curves were measured without backpressure in port A (external pilot oil drain) and T (internal pilot oil drain). With internal pilot oil drain the pressure in P or P2 increases by the output pressure present in port T.

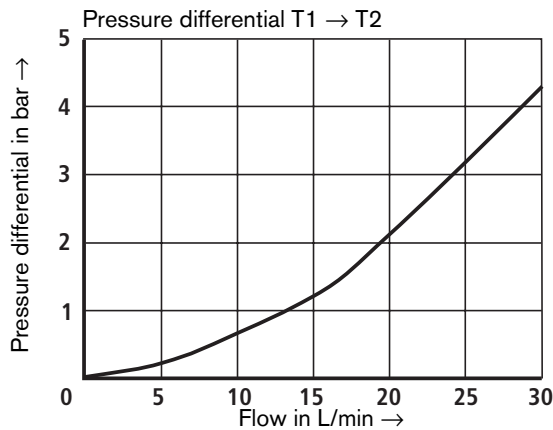
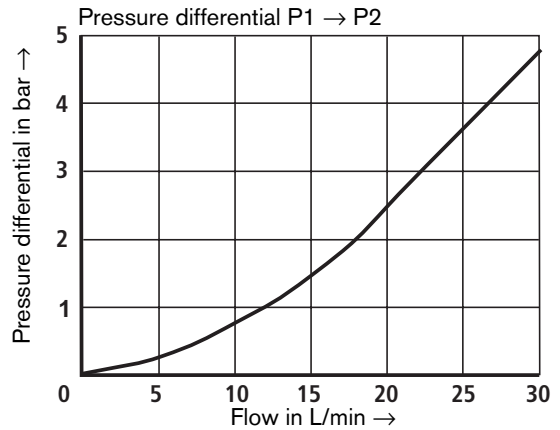
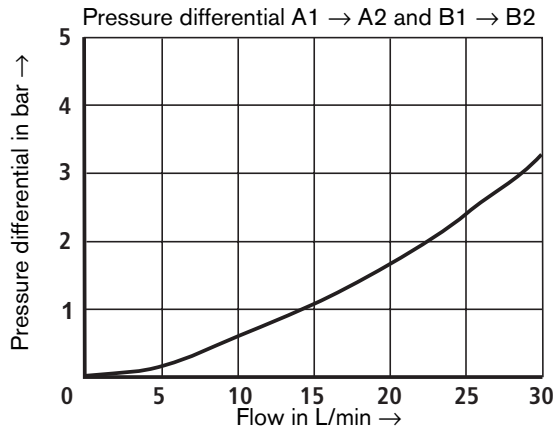

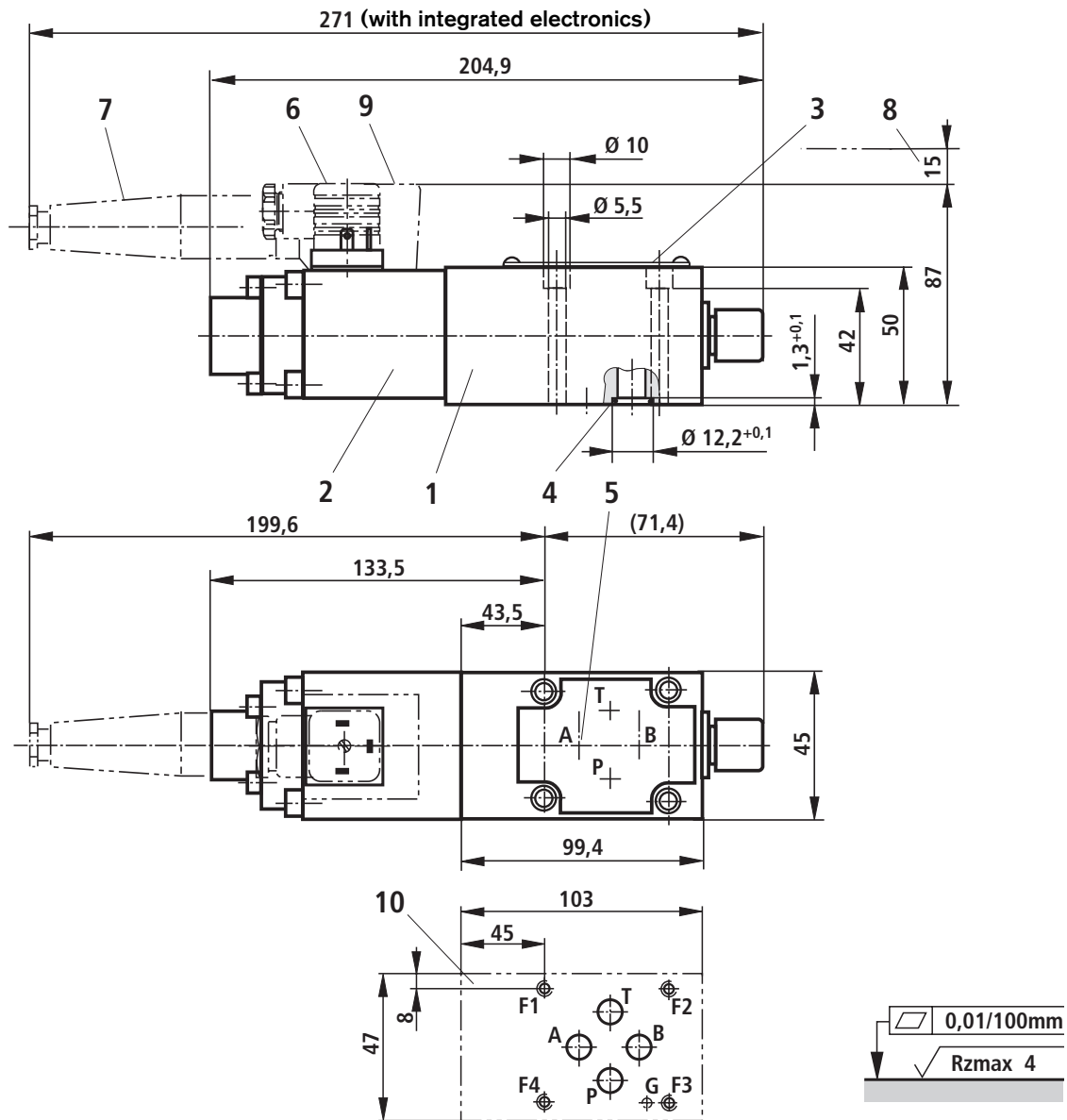
Unit dimensions: Types DBE and DBEE (nominal dimensions in mm)

Required surface quality of the mating part

- 1 Valve housing
- 2 Proportional solenoid
- 3 Nameplate
- 4 Identical seal rings for ports A, B, P and T
- 5 With version Y, pilot oil drain external via port A (Y)
- 6 Cable socket for type DBE (separate order, see page 6)
- 7 Cable socket for type DBEE (separate order, see page 6)
- 8 Space required to remove cable socket
- 9 Integrated electronics (OBE)
- 10 Machined mounting face, position of ports to DIN 24340 (**without** locating bore) and ISO 4401 (**with** locating bore)

Tolerances to: – General tolerances ISO 2768-mK
– Tolerancing principle ISO 8015

Subplates to data sheet RE 45052 and valve fixing screws must be ordered separately.

Subplates: G 341/01 (G 1/4)
G 342/01 (G 3/8)
G 502/01 (G 1/2)

Valve fixing screws:
4 socket head cap screws M5 x 50 DIN 912 10.9
Tightening torque $M_T = 7 \text{ Nm}$

Unit dimensions: Types ZDBE and ZDBEE (nominal dimensions in mm)

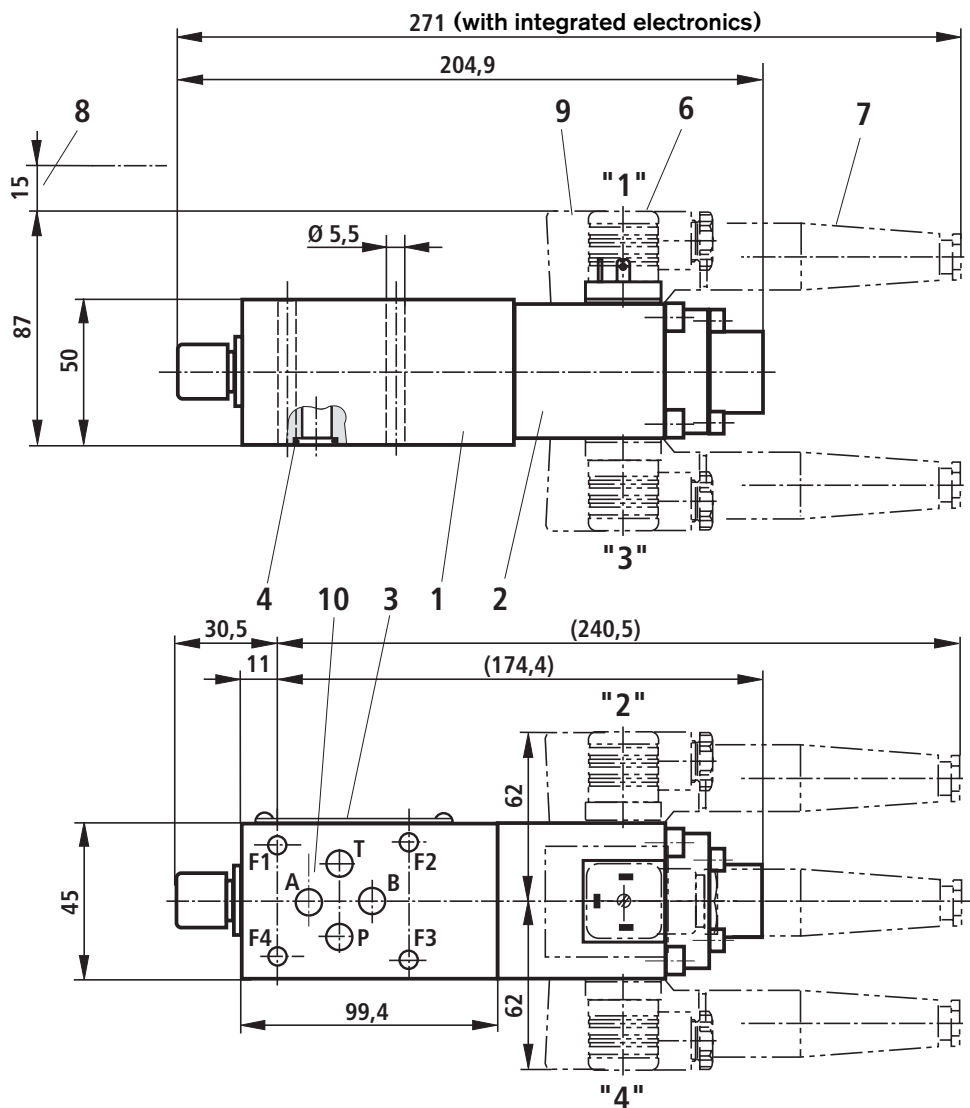

"1" to "4" – position of cable socket or housing with integrated electronics (see ordering code)

- 1 Valve housing
- 2 Proportional solenoid
- 3 Nameplate
- 4 Identical seal rings for ports A, B, P and T
- 6 Cable socket for type ZDBE (separate order, see page 6)
- 7 Cable socket for type ZDBEE (separate order, see page 6)
- 8 Space required to remove cable socket
- 9 Integrated electronics (OBE)
- 10 Machined mounting face, position of ports nach DIN 24340 (**without** locating bore) and ISO 4401 (**with** locating bore)

Required surface quality of the mating part

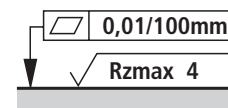

Tolerances to: – General tolerances ISO 2768-mK
– Tolerancing principle ISO 8015

Subplates to data sheet RE 45052 and valve fixing screws must be ordered separately.

Subplates: G 341/01 (G 1/4)
G 342/01 (G 3/8)
G 502/01 (G 1/2)

Valve fixing screws:
4 socket head cap screws M5 DIN 912 10.9
Tightening torque $M_T = 7 \text{ Nm}$

Notes

Bosch Rexroth AG
Hydraulics
Zum Eisengießer 1
97816 Lohr am Main, Germany
Phone +49 (0) 93 52 / 18-0
Fax +49 (0) 93 52 / 18-23 58
documentation@boschrexroth.de
www.boschrexroth.de

© This document, as well as the data, specifications and other information set forth in it, are the exclusive property of Bosch Rexroth AG. Without their consent it may not be reproduced or given to third parties.

The data specified above only serve to describe the product. No statements concerning a certain condition or suitability for a certain application can be derived from our information. The information given does not release the user from the obligation of own judgment and verification. It must be remembered that our products are subject to a natural process of wear and aging.