

MOSA M12 MALE 0° FIELD-WIREABLE (IDC)3-pol. 0.5...1.0mm²

Male straight

3-pole

Connection cross section: 0.5...1.0 mm²

Art.-No. 7005 - M12 Lite - (plastic hexagonal screw) on request

Plastic housings with good resistance against chemicals and oils. The resistance to aggressive media should be individually tested for your application. Further details on request.

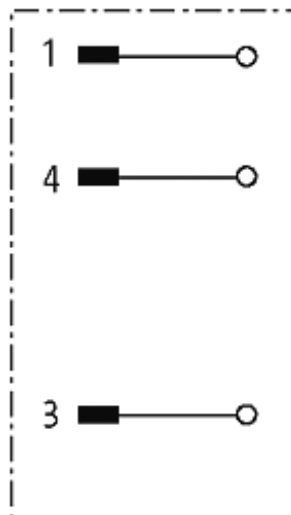
[Link to Product](#)**Illustration**

Male

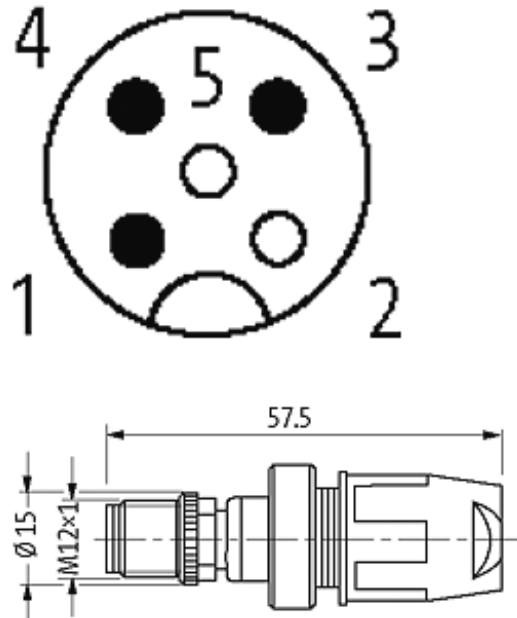

Product may differ from Image

Approvals



Form

12501

Technical Data

Operating voltage	max. 32 V AC/DC
Operating current per contact	max. 4 A
Connection cross section	0.5...1.0 mm ² (conductor diameter min. 0.1 mm)
Sealing range (cable diameter)	5.5...8 mm
Wire isolation	PVC, PP, TPE
Outer wire diameter	1.6...2.0 mm
Locking of ports	Screw thread M12 × 1 mm (recommended torque 0.6 Nm) self-securing
Protection	IP67 inserted and tightened (EN 60529)

General data

Temperature range	-25...+85 °C
Dimensions H × W × D	57.3×22×22 mm

Commercial data

country of origin	DE
customs tariff number	85369010
minimum order quantity	1