

# MAX30031/MAX30032/ MAX30033/MAX30034

# Defibrillation/Surge/ESD Protector

## General Description

The MAX30031–MAX30034 are patent-pending protection devices intended to (with the help of external, energy-rated resistors) absorb repetitive defibrillation and other high-energy pulses to protect sensitive electronic circuitry in ECG and other medical/industrial equipment. The devices can withstand over 100,000 defib pulses without failure.

The devices are intended to replace the gas-discharge tubes and transient absorbers in applications where its significant reduction in size is beneficial and its lower, well-defined on-voltage can offer higher degrees of protection to sensitive electronics.

The devices use a combination of a rugged integrated-circuit process and high-speed circuitry to ensure very fast turn-on times with trigger voltages low enough to not require secondary clamping circuitry. A low hold current of approximately 175mA ensures protection is maintained for the entire length of the high-energy transient event.

The MAX30031–MAX30034 are available in a small, 3mm x 5mm  $\mu$ MAX-8 package and are specified over the 0°C to +70°C temperature range.

**Ordering Information** appears at end of data sheet.

*$\mu$ MAX is a registered trademark of Maxim Integrated Products, Inc.*

## Typical Application Circuit

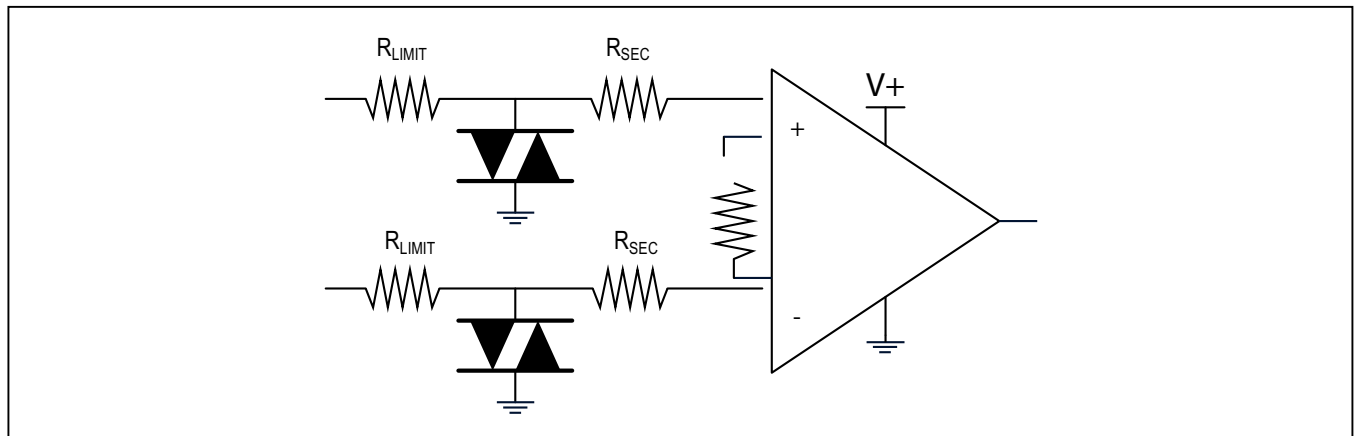

## Benefits and Features

- Low Leakage Defibrillation Protection IC Helps ECG Systems
- Low Capacitance ~ 3pF
- Low Leakage ~ 20pA @ 70°C
- Fast Turn-On < 2ns
- Low On-Voltage 3.9V (typ)
- High Peak Current in Excess of 4A
- Withstands Over 100k Defibrillation Pulses Without Failure
- 0°C to 70°C Temperature Range
- Small, 3mm X 5mm  $\mu$ MAX® Package

## Applications

- AED units
- Wearable Medical
- Clinical Patient Monitoring
- Industrial Equipment Protection
- Fixed Broadband Wireless Access

### Absolute Maximum Ratings

Peak Energy per Event .....	40mJ	Operating Temperature Range.....	0°C to 70°C
Continuous (> 1s) Current into Any Pin .....	±50mA	Storage Temperature Range.....	-40°C to +150°C
Junction Temperature T <sub>JMAX</sub> .....	150°C	Reflow Soldering Peak Temperature (Pb-free) .....	260°C
Continuous Power Dissipation (at T <sub>A</sub> = 70°C) .....	953mW		

Stresses beyond those listed under "Absolute Maximum Ratings" may cause permanent damage to the device. These are stress ratings only, and functional operation of the device at these or any other conditions beyond those indicated in the operational sections of the specifications is not implied. Exposure to absolute maximum rating conditions for extended periods may affect device reliability.

### Package Thermal Characteristics (Note 1)

μMAX

Junction-to-Ambient Thermal Resistance (θ <sub>JA</sub> ) .....	206°C/W
Junction-to-Case Thermal Resistance (θ <sub>JC</sub> ).....	8°C/W

**Note 1:** Package thermal resistances were obtained using the method described in JEDEC specification JESD51-7, using a four-layer board. For detailed information on package thermal considerations, refer to [www.maximintegrated.com/thermal-tutorial](http://www.maximintegrated.com/thermal-tutorial).

### Electrical Characteristics

(T<sub>A</sub> = T<sub>MIN</sub> to T<sub>MAX</sub>, unless otherwise noted. Typical values are at T<sub>A</sub> = +25°C. See VI curve (TOC1) for reference) (Note 2)

PARAMETER	SYMBOL	CONDITIONS	MIN	TYP	MAX	UNITS
<b>STATIC PERFORMANCE</b>						
Input Off-State Operating Voltage				±8		V
Input Trigger Voltage	V <sub>T</sub>	Either polarity		±10.3		V
Triggered Slope Resistance	R <sub>ON</sub>	Slope above the holding current and voltage		0.4		Ω
Holding Current	+I <sub>H</sub>			+175		mA
	-I <sub>H</sub>			-70		mA
Holding Voltage	+V <sub>H</sub>			+3.7		V
	-V <sub>H</sub>			-1.9		V
On-Voltage		At 1A, low duty-cycle, pulse tested		3.9		V
Input Capacitance		2V applied		2		pF
Input Leakage	I <sub>L</sub>	5V applied		0.003	1	nA
<b>DYNAMIC PERFORMANCE</b>						
Immunity Triggering		Either polarity, above this level of input slew rate will trigger the device when below the trigger voltage		1		V/ns
Turn-On Time		Input starts at 3.6V DC, then rises at 2V/μs. Turn-on time is from the start of the ramp to the time at which > 100mA is flowing		2		ns
Release Time		35mA to < 1μA		100		μs

**Note 2:** Limits are 100% tested at T<sub>A</sub> = +25°C, unless otherwise noted. Limits over the operating temperature range are guaranteed by design and characterization.

Typical Operating Characteristics

T<sub>A</sub> = +25°C, unless otherwise noted.

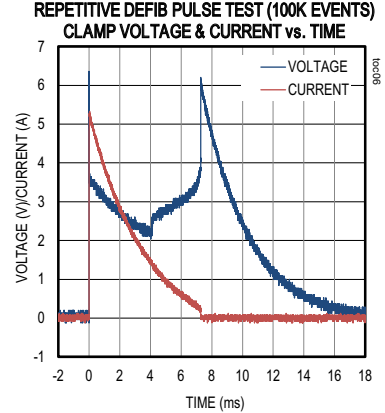
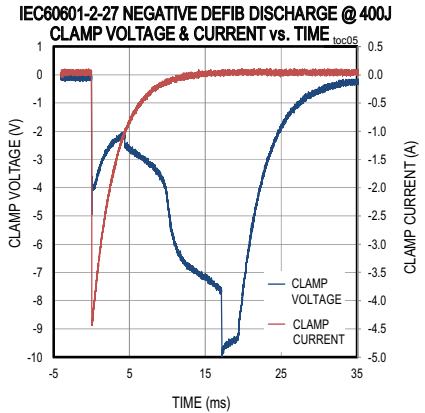
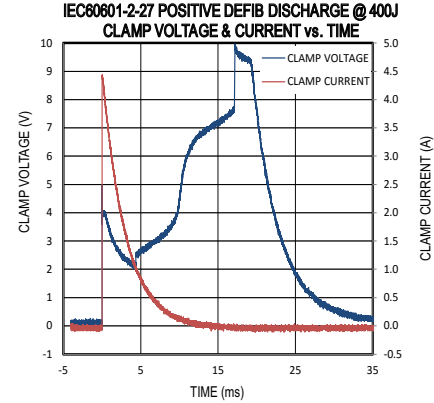
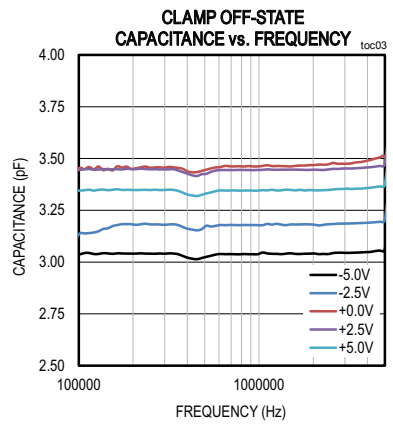
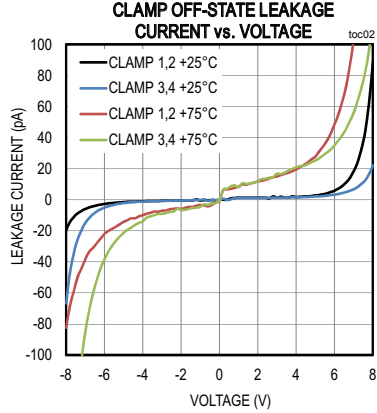
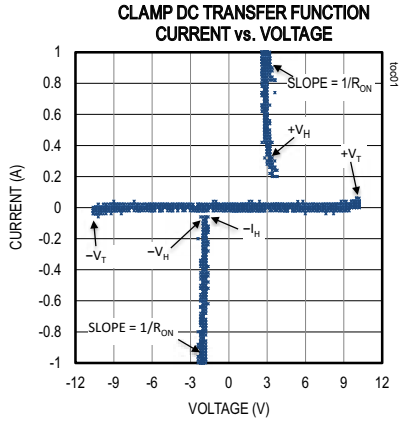

Typical Operating Characteristics (continued)

T<sub>A</sub> = +25°C, unless otherwise noted.

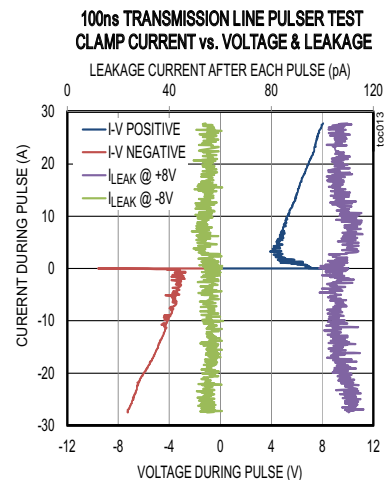
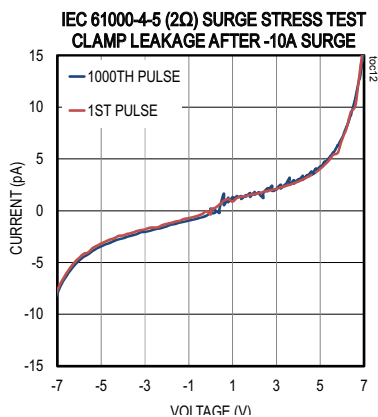
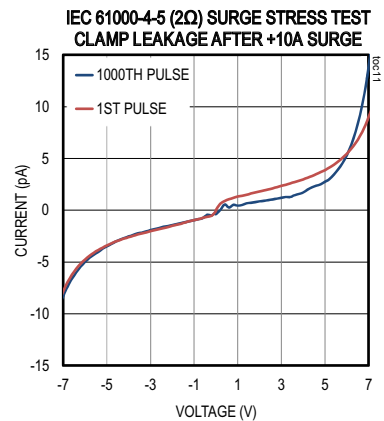
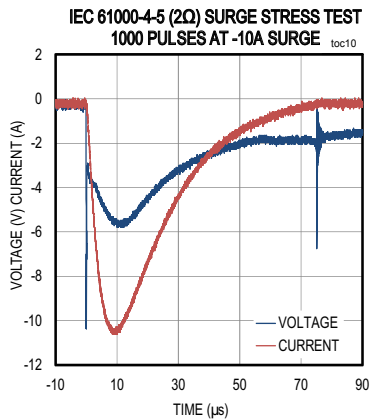
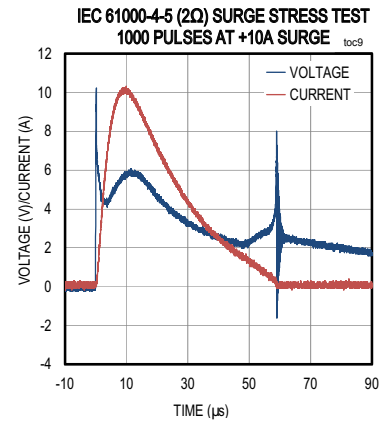
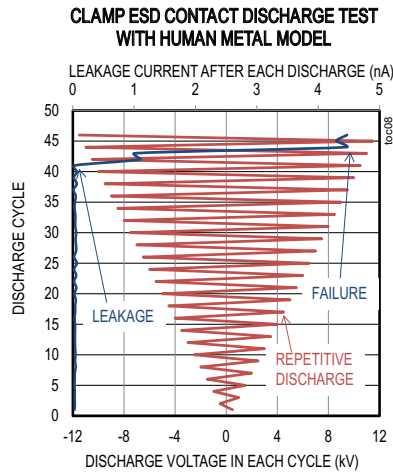
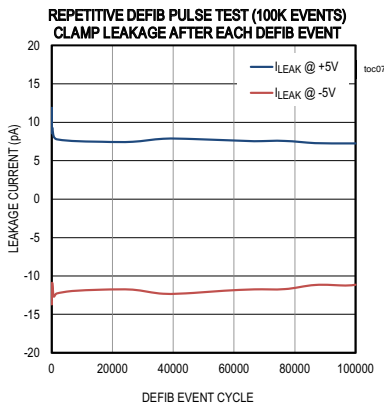

Pin Configurations

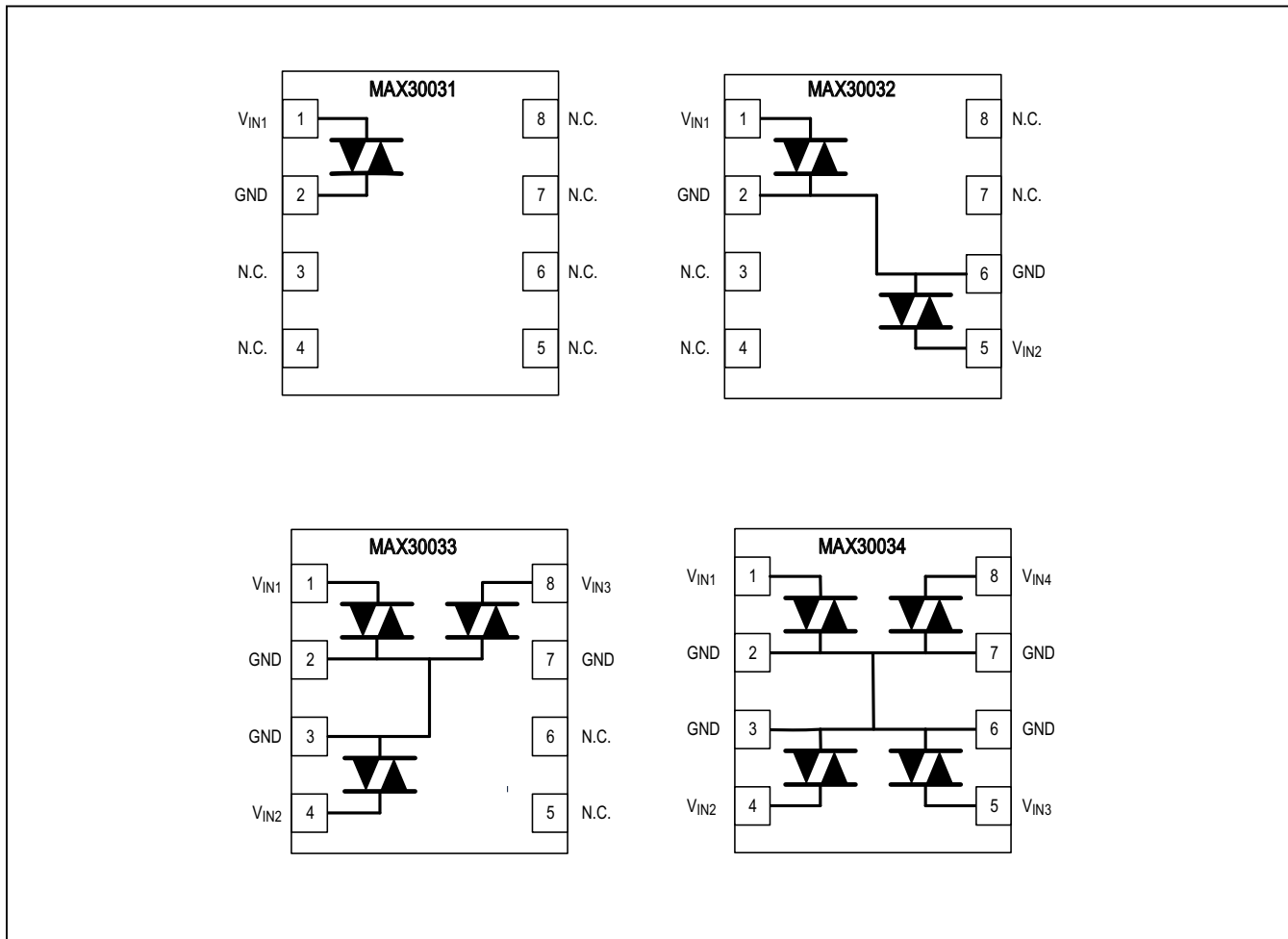

## Pin Descriptions

PIN	NAME	FUNCTION	COMMENTS
<b>MAX30031</b>			
1	V <sub>IN1</sub>	Clamp input 1	Tie to the input voltage to be clamped
2	GND	Ground	Tie to board GND
3	N.C.		
4	N.C.		
5	N.C.		
6	N.C.		
7	N.C.		
8	N.C.		
EP	GND	Exposed paddle	Tie to board GND
<b>MAX30032</b>			
1	V <sub>IN1</sub>	Clamp input 1	Tie to the input voltage to be clamped
2	GND	Ground	Tie to board GND
3	N.C.		
4	N.C.		
5	V <sub>IN2</sub>	Clamp input 2	Tie to the input voltage to be clamped
6	GND	Ground	Tie to board GND
7	N.C.		
8	N.C.		
EP	GND	Exposed paddle	Tie to system GND
<b>MAX30033</b>			
1	V <sub>IN1</sub>	Clamp input 1	Tie to the input voltage to be clamped
2	GND	Ground	Tie to board GND
3	GND	Ground	Tie to board GND
4	V <sub>IN2</sub>	Clamp input 2	Tie to the input voltage to be clamped
5	N.C.		
6	N.C.		
7	GND	Ground	Tie to board GND
8	V <sub>IN3</sub>	Clamp input 3	Tie to the input voltage to be clamped
EP	GND	Exposed paddle	Tie to board GND
<b>MAX30034</b>			
1	V <sub>IN1</sub>	Clamp input 1	Tie to the input voltage to be clamped
2	GND	Ground	Tie to board GND
3	GND	Ground	Tie to board GND
4	V <sub>IN2</sub>	Clamp input 2	Tie to the input voltage to be clamped
5	V <sub>IN3</sub>	Clamp input 3	Tie to the input voltage to be clamped
6	GND	Ground	Tie to board GND
7	GND	Ground	Tie to board GND
8	V <sub>IN4</sub>	Clamp input 4	Tie to the input voltage to be clamped
EP	GND	Exposed paddle	Tie to board GND

## Detailed Description

The MAX3003\_ defibrillation pulse protectors are specifically designed to protect the input of ECG and respiration detection circuits from a maximum discharge of 400J with the maximum allowable shunted energy into the ECG protection circuit. These devices operate as bidirectional voltage trigger clamps. When the voltage across the terminals of the device goes above approximately +10.3V or below -10.3V, the impedance across the device drops from well over  $10^{10}\Omega$  to less than  $1\Omega$ . This drop of impedance across the device conducts sufficient current so as to clamp the voltage across its terminals to protect the input of sensitive electronics. TOC1 illustrates the VI characteristic of the MAX3003\_.

The MAX3003\_ do not dissipate the majority of the defibrillation pulse energy, rather they clamp the voltage at the input to a low voltage, forcing the majority of the defib energy to be dissipated in an external energy rated resistor,  $R_{LIMIT}$ . This external energy-rated resistor should be sized to limit the energy absorbed by the ECG system to within the limits specified by IEC and AAMI requirements.

The voltage across the MAX3003\_, when triggered on, is approximately  $V_{ON} = 3.5V + I_{CLAMP} \times R_{ON}$ , where  $I_{CLAMP}$  is the current flowing through the MAX3003\_ and will be given by  $I_{CLAMP} = V_{APPLIED}/R_{LIMIT}$ .  $R_{ON}$  is the MAX3003\_ on state impedance given in the electrical characteristics table. Thus the current in the MAX3003\_, produces a power dissipation in the device of  $P_{MAX3003\_} = 3.5V \times I_{CLAMP} + R_{ON} \times I_{CLAMP}^2$ . The peak energy per defib pulse must be kept below the maximum shown in the absolute maximum ratings.

Before the MAX3003\_ go into a clamp state, the voltage can briefly exceed 10.3V (typ). So a secondary protection resistor ( $R_{SEC}$ ) between the MAX3003\_ and the ECG input circuit is recommended. Virtually all modern circuitry have ESD protection at their inputs to clamp the input to an acceptably low voltage. These clamps are generally designed to protect the input against limited ESD and latch-up events. Thus  $R_{SEC}$  should be sized to limit the current into the ECG input to levels below the absolute maximum rating of the device and would typically be part of the input filtering network. Generally  $R_{SEC}$  would be as low as a few hundred ohms and dissipate very little energy during a defib event. For example, if the instrumentation amplifier supply is 3V, then  $R_{SEC} > (10.3V - 3.7V)/I_{MAX}$ , where  $I_{MAX}$  is the maximum current specified in the instrumentation amplifier data sheet.

MAX3003\_ will fall out of the conduction state and return to a low-leakage off-state once the terminal current drops below the hold current, of approximately +175mA or -55mA. When in the off state, the MAX3003\_ exhibit extremely low leakage, typically less than 10pA at room temperature as well as low capacitance, typically 3.3pF. Thus the device has little or no impact on the characteristics of the ECG input signal-conditioning network.

In addition to defib protection, the MAX3003\_ is an extremely fast device. Thus, it is capable of also serving as an IEC61000-4-2 high ESD protection device, eliminating the need for multiple protection components at the front-end of an ECG system. TOC8 illustrates multiple direct ( $R_{LIMIT} = 0\Omega$ ) HMM ESD hits at various voltages. The HMM ESD model is essentially an IEC61000-4-2 ESD model with a hard GND connection and contact discharge. Thus, it represents a worst-case IEC61000-4-2 scenario. As can be seen from TOC8, the MAX3003\_ are able to tolerate a worst case IEC61000-4-2 contact discharge to well over 8kV without damage.

The MAX3003\_ are “snap-back” type clamp structures and are specifically designed for applications where the normal circuit impedance is high enough that the minimum hold current cannot be supported, such as ECG defib protection. In such a case the MAX3003\_ are guaranteed to turn off when the transient condition is removed and will not remain in a clamp condition causing potential damage.

If the MAX3003\_ were to be used in an application where the circuit impedance was low enough to support the minimum hold current, such as a power supply clamping application, then the devices could result in excessively high DC current to flow once triggered by an overdrive condition. In such a situation, the MAX3003\_ could be destroyed and could destroy other circuitry in the process.

To ensure that the intended circuit is appropriate for use with the MAX3003\_, analyze the target circuit with a short circuit in place of the MAX3003\_. If the current in that short circuit is less than the minimum hold current, then the MAX3003\_ would work for that application.

## Ordering Information

PART	TEMP RANGE	PIN-PACKAGE
MAX30031CUA+*	0°C to 70°C	8- $\mu$ MAX
MAX30032CUA+*	0°C to 70°C	8- $\mu$ MAX
MAX30033CUA+*	0°C to 70°C	8- $\mu$ MAX
MAX30034CUA+	0°C to 70°C	8- $\mu$ MAX

+Denotes lead(Pb)-free/RoHS compliant package.

\*Future Product—Contact factory for availability.

## Chip Information

PROCESS: CMOS

## Package Information

For the latest package outline information and land patterns (footprints), go to [www.maximintegrated.com/packages](http://www.maximintegrated.com/packages). Note that a "+", "#", or "-" in the package code indicates RoHS status only. Package drawings may show a different suffix character, but the drawing pertains to the package regardless of RoHS status.

PACKAGE TYPE	PACKAGE CODE	OUTLINE NO.	LAND PATTERN NO.
TDFN	U8+4	<a href="#">21-0036</a>	<a href="#">90-0092</a>



MAX30031/MAX30032/  
MAX30033/MAX30034

Defibrillation/Surge/ESD Protector

## Revision History

REVISION NUMBER	REVISION DATE	DESCRIPTION	PAGES CHANGED
0	3/16	Initial release	—

For pricing, delivery, and ordering information, please contact Maxim Direct at 1-888-629-4642, or visit Maxim Integrated's website at [www.maximintegrated.com](http://www.maximintegrated.com).

*Maxim Integrated cannot assume responsibility for use of any circuitry other than circuitry entirely embodied in a Maxim Integrated product. No circuit patent licenses are implied. Maxim Integrated reserves the right to change the circuitry and specifications without notice at any time. The parametric values (min and max limits) shown in the Electrical Characteristics table are guaranteed. Other parametric values quoted in this data sheet are provided for guidance.*