

No.	Changes and/or Note No.	Date	Intr	No	Changes and/or Note No.	Date	Intr

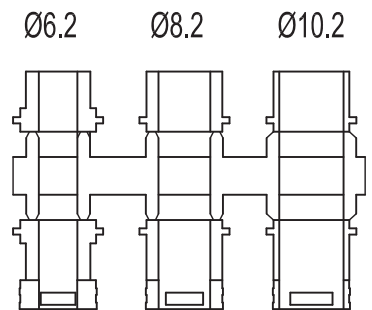
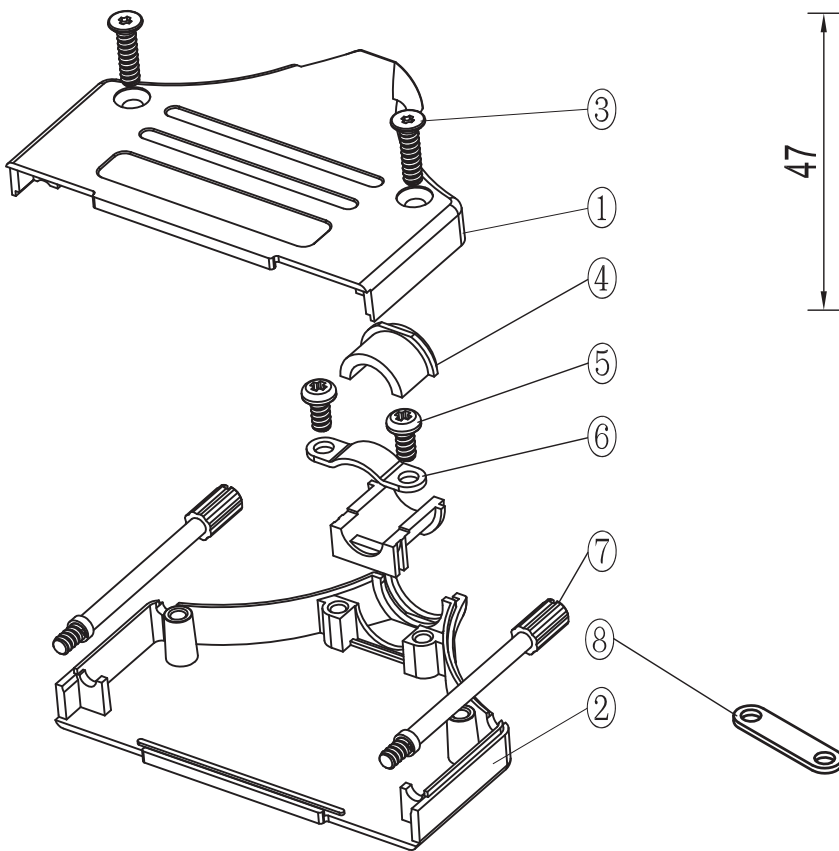
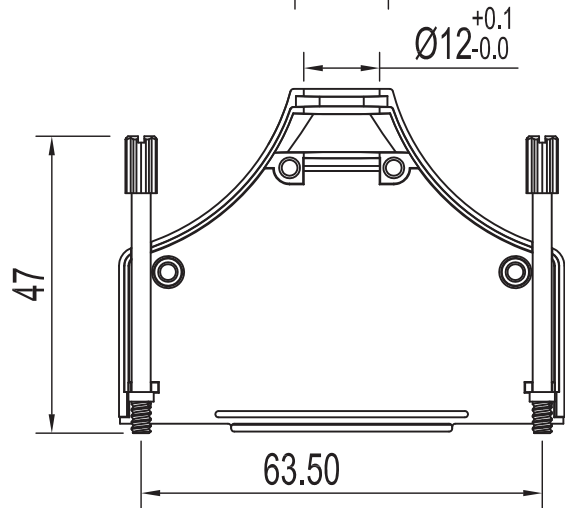
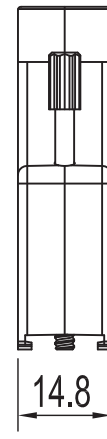
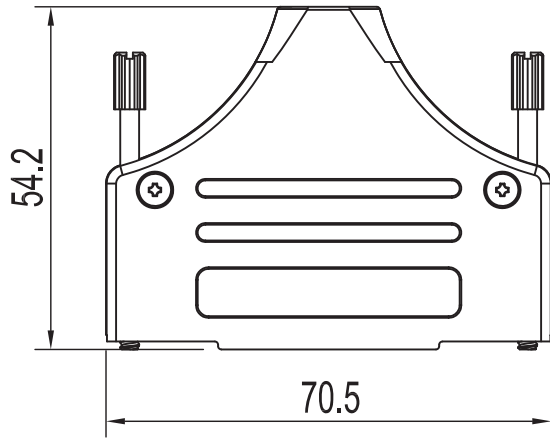

Grommet Set

Part Number:	Description:	Pack:	Item	QTY	Part description
6560-0136-04	MHDM37-K	Kit	1	1	MHDM37-Upper cover
			2	1	MHDM37-Lower cover
			3	2	M3X12 Countersunk screw
			4	1	DM-D1 Grommet set
6561-0136-04	MHDM37	Bulk	5	2	M3X6 Screw
			6	1	DM-Clamp-R
			7	2	UNC 4-40X47 Jackscrew
			8	1	DM-Clamp-F

DATE: 2011-08-15	DRAWN: MRR	SCALE:	MATERIAL TYPE:	GENERAL TOLERANCES UNLESS OTHERWISE STATED LINEAR 0 ±0.20 0.0 ±0.15 0.00 ±0.10 ANGULAR ±0°30' ALL DIMENSIONS IN mm THIRD ANGLE PROJECTION
	APPROVED:		REPLACES:	

	MHDM SERIES		DRAWING No:	6688-9592