

No.	Changes and/or Note	Date	Intr	No	Changes and/or Note	Date	Intr

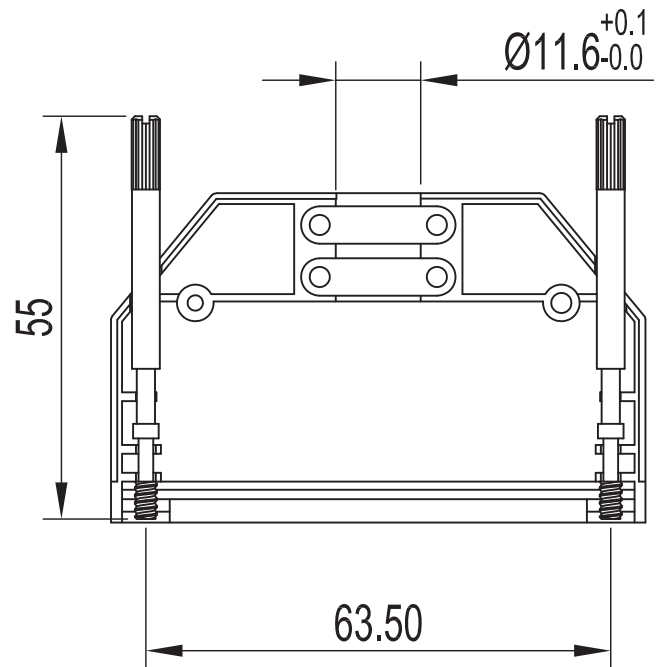
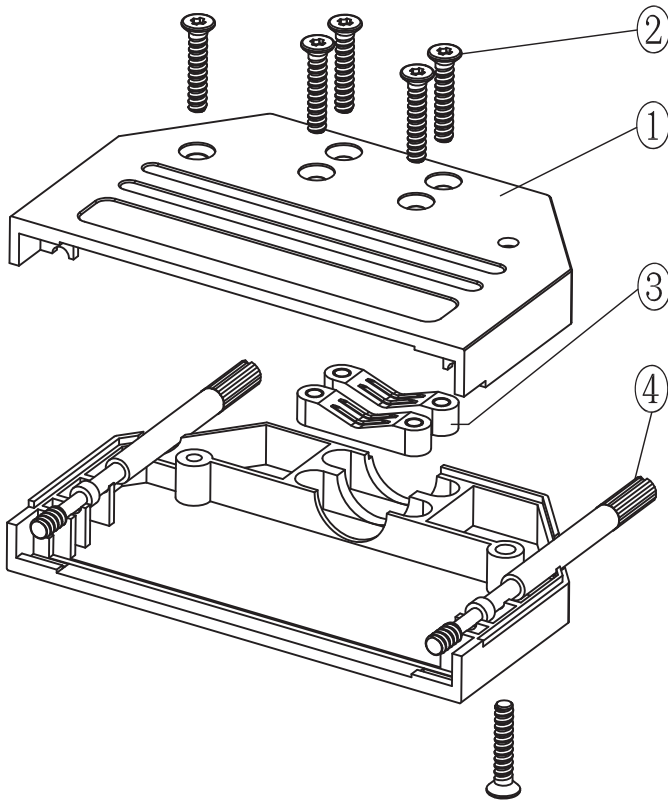
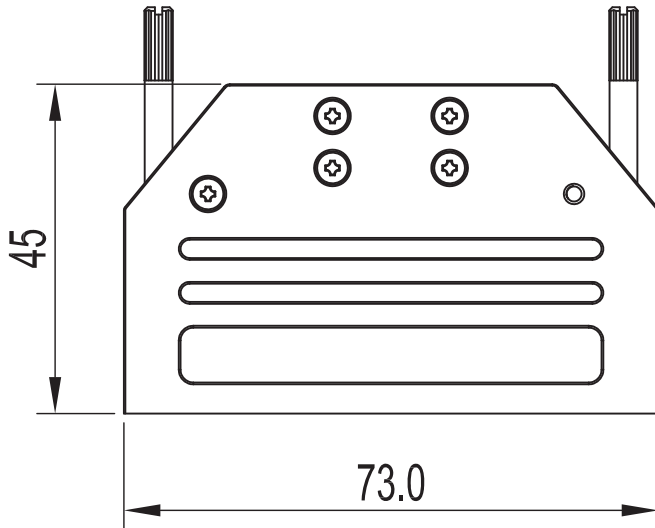

Part Number:	Description:	Pack:	Item	QTY	Part description
6560-0305-04	DTZI37-K	Kit	1	2	DTZI37 Cover
6561-0305-04	DTZI37	Bulk	2	6	M2.5X14 Countersunk screw
			3	2	DTZI37-Clamp
			4	2	UNC 4-40X55 Jackscrew
DATE: 2011-04-12	DRAWN: MRR	SCALE:	MATERIAL TYPE:		GENERAL TOLERANCES UNLESS OTHERWISE STATED LINEAR 0 ±0.20 0.0 ±0.15 0.00 ±0.10 ANGULAR ±0°30' ALL DIMENSIONS IN mm THIRD ANGLE PROJECTION
	APPROVED:		REPLACES:		
			DTZI-SERIES		
			DRAWING No: 6688-9604		