



Figure can vary

Part no.: 50141869

PRK3C/4P

Polarized retro-reflective photoelectric sensor



Contents

- Technical data
- Dimensioned drawings
- Electrical connection
- Diagrams
- Operation and display
- Reflectors & reflective tapes
- Part number code
- Notes
- Accessories

Technical data

Basic data	
Series	3C
Operating principle	Reflection principle
Optical data	
Operating range	Guaranteed operating range
Operating range	0.1 ... 5 m , With reflector TK(S) 100x100
Operating range limit	Typical operating range
Operating range limit	0.1 ... 6 m , With reflector TK(S) 100x100
Light source	LED , Red
LED light wavelength	633 nm
LED group	Exempt group (in acc. with EN 62471)
Transmitted-signal shape	Pulsed
Electrical data	
Protective circuit	Polarity reversal protection Short circuit protected
Performance data	
Supply voltage U_B	10 ... 30 V , DC , Incl. residual ripple
Residual ripple	0 ... 15 % , From U_B
Open-circuit current	0 ... 20 mA
Outputs	
Number of digital switching outputs	2 Piece(s)
Switching outputs	
Voltage type	DC
Switching current, max.	100 mA
Switching voltage	High: $\geq(U_B-2V)$ Low: $\leq 2V$
Switching output 1	
Switching element	Transistor , PNP
Switching principle	Light switching
Switching output 2	
Switching element	Transistor , PNP
Switching principle	Dark switching
Timing	
Switching frequency	1,500 Hz
Response time	0.33 ms
Readiness delay	300 ms
Connection	

Part no.: 50141869 – PRK3C/4P – Polarized retro-reflective photoelectric sensor

Connection 1

Function	Signal OUT Voltage supply
Type of connection	Cable
Cable length	2,000 mm
Sheathing material	PUR
Cable color	Black
Number of conductors	4 -wire
Wire cross section	0.2 mm ²

Mechanical data

Dimension (W x H x L)	11.4 mm x 34.2 mm x 18.3 mm
Housing material	Plastic , PC-ABS
Lens cover material	Plastic / PMMA
Net weight	50 g
Housing color	Red
Type of fastening	Through-hole mounting Via optional mounting device
Compatibility of materials	ECOLAB

Operation and display

Type of display	LED
Number of LEDs	2 Piece(s)

Environmental data

Ambient temperature, operation	-40 ... 60 °C
Ambient temperature, storage	-40 ... 70 °C

Certifications

Degree of protection	IP 67 IP 69K
Protection class	III
Certifications	c UL US
Standards applied	IEC 60947-5-2

Classification

Customs tariff number	85365019
eCl@ss 8.0	27270902
eCl@ss 9.0	27270902
ETIM 5.0	EC002717
ETIM 6.0	EC002717

Dimensioned drawings

All dimensions in millimeters

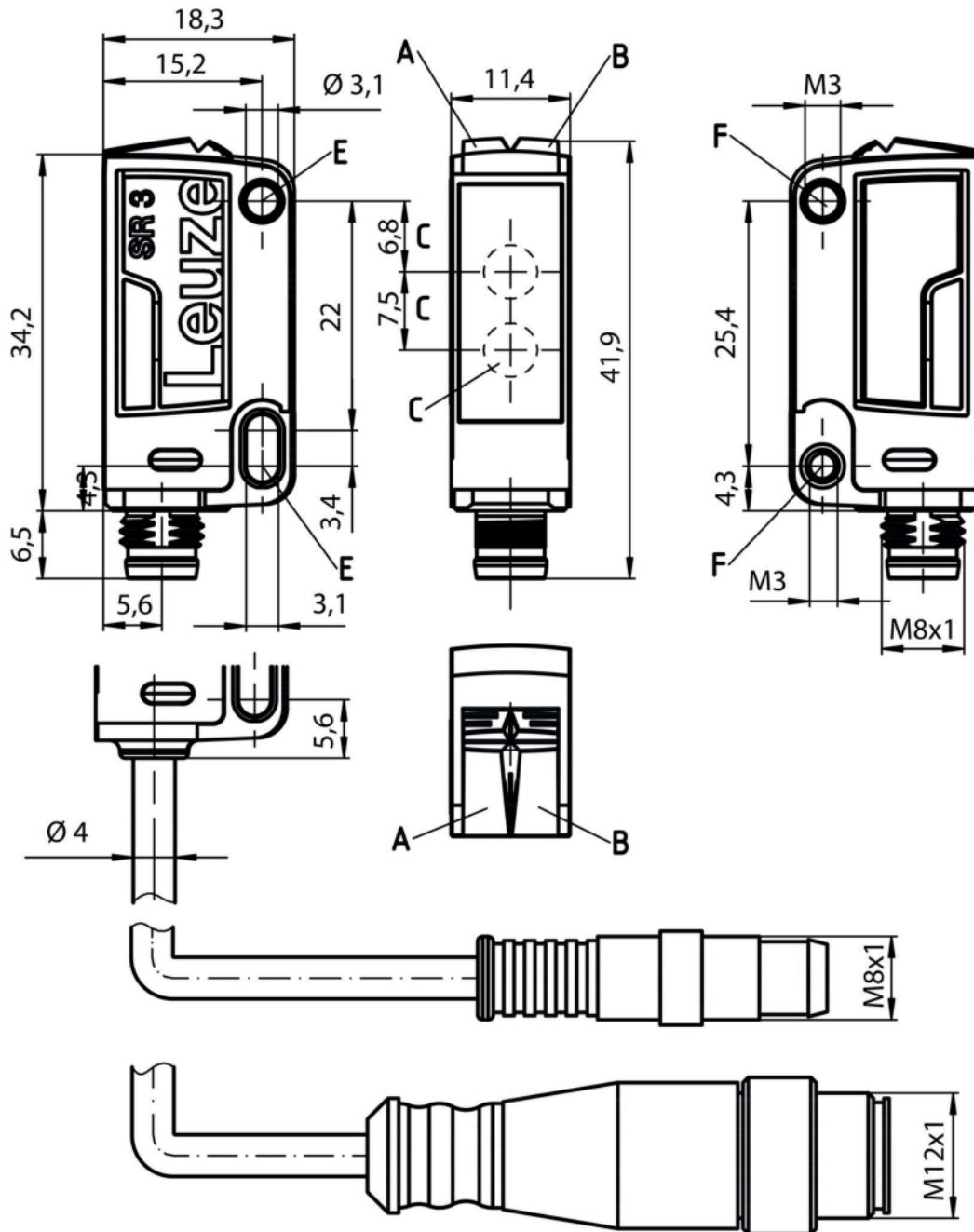

- A Green LED
- B Yellow LED
- C Optical axis
- E Mounting sleeve (standard)
- F Threaded sleeve (3C.B series)

Electrical connection

Connection 1	
Function	Signal OUT Voltage supply
Type of connection	Cable
Cable length	2,000 mm
Sheathing material	PUR

Part no.: 50141869 – PRK3C/4P – Polarized retro-reflective photoelectric sensor

Connection 1	
Cable color	Black
Number of conductors	4 -wire
Wire cross section	0.2 mm ²

Conductor color	Conductor assignment
Brown	V+
White	OUT 2
Blue	GND
Black	OUT 1

Diagrams

Typ. response behavior

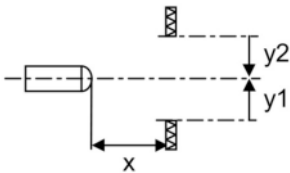
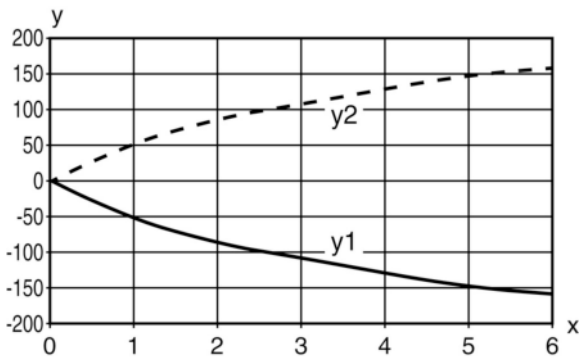

x Distance [m]
y Misalignment [mm]

Typ. function reserve

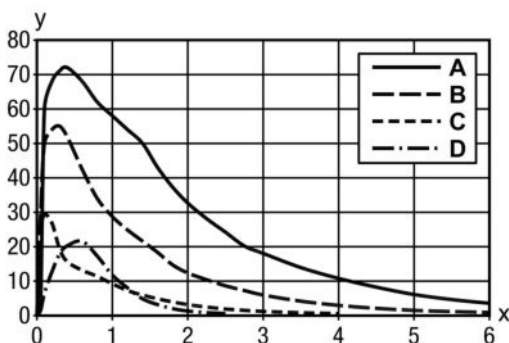





x	Distance [m]
y	Function reserve
A	TKS 100x100
B	TKS 40x60
C	TKS 20x40
D	Film REF 4-A-50x50

Operation and display



LEDs

LED	Display	Meaning
1	Green, continuous light	Ready
2	Yellow, continuous light	Light path free
	Yellow, flashing	Light path free, no function reserve

Reflectors & reflective tapes

	Part no.	Designation	Operating range/ Operating range limit	Description
	50108300	REF 4-A-50x50	0.1 ... 1.2 m 0.1 ... 1.6 m	Design: Rectangular Reflective surface: 50 mm x 50 mm Material: Plastic Chemical designation of the material: PMMA Fastening: Self-adhesive
	50003192	TK 100x100	0.1 ... 5 m 0.1 ... 6 m	Design: Rectangular Reflective surface: 96 mm x 96 mm Triple reflector size: 4 mm Material: Plastic Base material: Plastic Chemical designation of the material: PMMA8N Fastening: Adhesive
	50003189	TK 30x50	0.1 ... 1.2 m 0.1 ... 1.6 m	Design: Rectangular Reflective surface: 29 mm x 45 mm Triple reflector size: 4 mm Material: Plastic Base material: Plastic Chemical designation of the material: PMMA8N Fastening: Adhesive
	50024127	TK 82.2	0.1 ... 1.2 m 0.1 ... 1.6 m	Design: Round Triple reflector size: 4 mm Reflection surface diameter: 79 mm Material: Plastic Base material: Plastic Chemical designation of the material: PMMA8N Fastening: Through-hole mounting, Adhesive
	50022816	TKS 100X100	0.1 ... 5 m 0.1 ... 6 m	Design: Rectangular Reflective surface: 96 mm x 96 mm Triple reflector size: 4 mm Material: Plastic Base material: Plastic Chemical designation of the material: PMMA8N Fastening: Through-hole mounting, Adhesive

Part no.: 50141869 – PRK3C/4P – Polarized retro-reflective photoelectric sensor

	Part no.	Designation	Operating range/ Operating range limit	Description
	50081283	TKS 20X40	0.1 ... 1.5 m 0.1 ... 2 m	Design: Rectangular Reflective surface: 16 mm x 38 mm Triple reflector size: 2.3 mm Material: Plastic Base material: Plastic Chemical designation of the material: PMMA8N Fastening: Through-hole mounting, Adhesive
	50023525	TKS 30X50	0.1 ... 1.2 m 0.1 ... 1.6 m	Design: Rectangular Reflective surface: 27 mm x 44 mm Triple reflector size: 3 mm Material: Plastic Base material: Plastic Chemical designation of the material: PMMA8N Fastening: Through-hole mounting, Adhesive
	50040820	TKS 40X60	0.1 ... 3 m 0.1 ... 3.6 m	Design: Rectangular Reflective surface: 37 mm x 56 mm Triple reflector size: 4 mm Material: Plastic Base material: Plastic Chemical designation of the material: PMMA8N Fastening: Through-hole mounting, Adhesive

Part number code

 Part designation: **AAA 3C d EE-f.GG H/i J-K**

AAA3C	Operating principle / construction: HT3C: diffuse reflection sensor with background suppression LS3C: throughbeam photoelectric sensor transmitter LE3C: throughbeam photoelectric sensor receiver PRK3C: retro-reflective photoelectric sensor with polarization filter
d	Light type: n/a: red light l: infrared light
EE	Light source: n/a: LED L1: laser class 1 L2: laser class 2
f	Preset range (optional): n/a: operating range acc. to data sheet xxxF: preset range [mm]
GG	Equipment: n/a: standard A: autocollimation principle (single lens) for positioning tasks B: housing model with two M3 threaded sleeves, brass F: permanently set range L: long light spot S: small light spot T: autocollimation principle (single lens) for highly transparent bottles without tracking TT: autocollimation principle (single lens) for highly transparent bottles with tracking V: V-optics XL: extra long light spot X: extended model
H	Operating range adjustment: n/a with HT: range adjustable via 8-turn potentiometer n/a with retro-reflective photoelectric sensors (PRK): operating range not adjustable 1: 270° potentiometer 3: teach-in via button 6: auto-teach

Part no.: 50141869 – PRK3C/4P – Polarized retro-reflective photoelectric sensor

i	Switching output/function OUT 1/IN: Pin 4 or black conductor: 2: NPN transistor output, light switching N: NPN transistor output, dark switching 4: PNP transistor output, light switching P: PNP transistor output, dark switching 6: push-pull switching output, PNP light switching, NPN dark switching G: push-pull switching output, PNP dark switching, NPN light switching L: IO-Link interface (SIO mode: PNP light switching, NPN dark switching) 8: activation input (activation with high signal) X: pin not used 1: IO-Link / light switching (NPN) / dark switching (PNP)
J	Switching output / function OUT 2/IN: pin 2 or white conductor: 2: NPN transistor output, light switching N: NPN transistor output, dark switching 4: PNP transistor output, light switching P: PNP transistor output, dark switching 6: push-pull switching output, PNP light switching, NPN dark switching G: push-pull switching output, PNP dark switching, NPN light switching W: warning output X: pin not used 8: activation input (activation with high signal) 9: deactivation input (deactivation with high signal) T: teach-in via cable
K	Electrical connection: n/a: cable, standard length 2000 mm, 4-wire 5000: cable, standard length 5000 mm, 4-wire M8: M8 connector, 4-pin (plug) M8.3: M8 connector, 3-pin (plug) 200-M8: cable, length 200 mm with M8 connector, 4-pin, axial (plug) 200-M8.3: cable, length 200 mm with M8 connector, 3-pin, axial (plug) 200-M12: cable, length 200 mm with M12 connector, 4-pin, axial (plug)

Note

A list with all available device types can be found on the Leuze website at www.leuze.com.

Notes

Observe intended use!

- This product is not a safety sensor and is not intended as personnel protection.
- The product may only be put into operation by competent persons.
- Only use the product in accordance with its intended use.

For UL applications:

- For UL applications, use is only permitted in Class 2 circuits in accordance with the NEC (National Electric Code).
- These proximity switches shall be used with UL Listed Cable assemblies rated 30V, 0.5A min, in the field installation, or equivalent (categories: CYJV/CYJV7 or PVVA/PVVA7)

- Light source: Average life expectancy 100,000 h at an ambient temperature of 25 °C
- Response time: For short decay times, an ohmic load of approx. 5 kOhm is recommended
- Sum of the output currents for both outputs, 50 mA for ambient temperatures > 40 °C
- The push-pull switching outputs must not be connected in parallel.

Part no.: 50141869 – PRK3C/4P – Polarized retro-reflective photoelectric sensor

Accessories



Mounting technology - Mounting brackets

	Part no.	Designation	Article	Description
	50060511	BT 3	Mounting device	Design of mounting device: Angle, L-shape Fastening, at system: Through-hole mounting Mounting bracket, at device: Screw type Type of mounting device: Rigid Material: Metal

Mounting technology - Rod mounts

	Part no.	Designation	Article	Description
	50117255	BTU 200M-D12	Mounting system	Design of mounting device: Mounting system Fastening, at system: For 12 mm rod, Sheet-metal mounting Mounting bracket, at device: Screw type, Suited for M3 screws Type of mounting device: Clampable, Adjustable, Turning, 360° Material: Metal

Standard reflectors

	Part no.	Designation	Article	Description
	50081283	TKS 20X40	Reflector	Design: Rectangular Reflective surface: 16 mm x 38 mm Triple reflector size: 2.3 mm Material: Plastic Base material: Plastic Chemical designation of the material: PMMA8N Fastening: Through-hole mounting, Adhesive
	50040820	TKS 40X60	Reflector	Design: Rectangular Reflective surface: 37 mm x 56 mm Triple reflector size: 4 mm Material: Plastic Base material: Plastic Chemical designation of the material: PMMA8N Fastening: Through-hole mounting, Adhesive

Reflective tapes for standard applications

	Part no.	Designation	Article	Description
	50108300	REF 4-A-50x50	Reflective tape	Design: Rectangular Reflective surface: 50 mm x 50 mm Material: Plastic Chemical designation of the material: PMMA Fastening: Self-adhesive

Note

A list with all available accessories can be found on the Leuze electronic website in the Download tab of the article detailed page.