

M12 MALE 0° WIREABLE SCREW TERM.4-pol. max.0,75mm² 4-6mm

Male straight

4-pole

Clamping range cable entry: 4...6 mm

Plastic housings with good resistance against chemicals and oils. The resistance to aggressive media should be individually tested for your application. Further details on request.

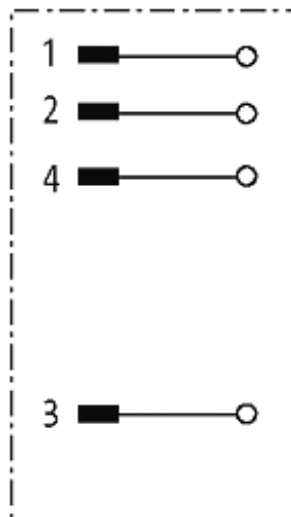
[Link to Product](#)**Illustration**

Male

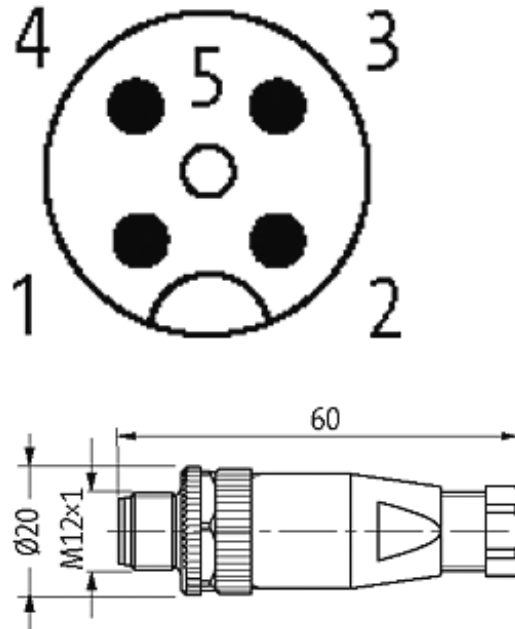

Product may differ from Image

Approvals



Form

12701

Technical Data

Operating voltage	max. 250 V AC/DC
Operating current per contact	max. 4 A
Connection cross section	max. 0.75 mm ²
Sealing range (cable diameter)	4...6 mm
Locking of ports	Screw thread M12 × 1 mm (recommended torque 0.6 Nm) self-securing
Protection	IP67 inserted and tightened (EN 60529)

General data

Temperature range	-25...+85 °C
Dimensions H × W × D	60×20×20 mm

Commercial data

country of origin	DE
customs tariff number	85369010

minimum order quantity

1