

M12 male / M12 female 0° shielded Cube67

PUR 0.5+0.25 shielded gn UL/CSA+drag ch. 9,5m

Cube67, 6-pole

Hybrid cable for communication and supply

Male straight to female straight

M12 - M12

6-pole used, shielded

Plastic housings with good resistance against chemicals and oils. The resistance to aggressive media should be individually tested for your application. Further details on request. Further cable lengths on request.

[Link to Product](#)

Illustration

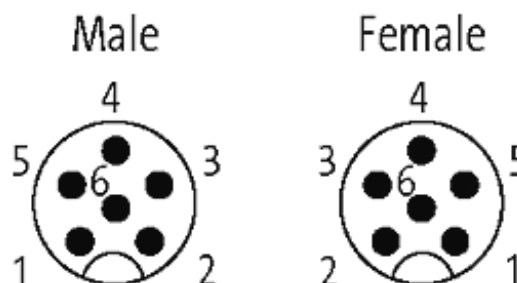
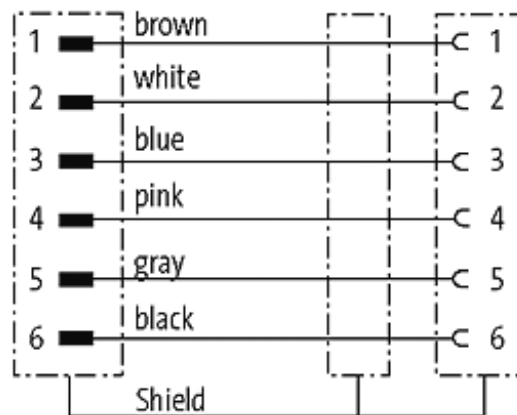



Product may differ from Image

Approvals



More Info

Cube67

Form

46041

Technical Data

Operating voltage	max. 30 V AC/DC
Operating current per contact	max. 4 A
Locking of ports	Screw thread M12 × 1 mm (recommended torque 0.6 Nm) self-securing
Protection	IP67 inserted and tightened (EN 60529)

Cables

Cable number	802
No./diameter of wires	4×0.5 + 2×0.25 mm ²
Wire isolation	PP (br, bl, bk, wh), (gr, pk)
C-track properties	5 Mio.
Torsion	± 180 °/m
Jacket Color	green
Shore hardness outer jacket	90 ± 5A
Material (jacket)	PUR (UL/CSA)
Outer diameter	approx. 7.9 mm
Bend radius (fixed)	5 × outer Ø

The information in this brochure has been compiled with the utmost care.

Liability for the correctness completeness and topicality of the information is restricted to gross negligence. Version: 05/15

Bend radius (moving)	10 × outer Ø
Temperature range (fixed)	-50...+80 °C
Temperature range (mobile)	-40...+80 °C
Shielded	yes

Commercial data

country of origin	DE
customs tariff number	85444290
minimum order quantity	1