

REAR INSULATINGPLATE OFFSET 4 POLE 1 PCS. ACCESSORY
FOR: 3VA6 400/600



Model

Product brand name	SETRON
Product designation	accessories

Certificates

General Product Approval	EMC	Declaration of Conformity	other
--------------------------	-----	---------------------------	-------



[Miscellaneous](#)

Further information

Information- and Downloadcenter (Catalogs, Brochures,...)

<http://www.siemens.com/lowvoltage/catalogs>

Industry Mall (Online ordering system)

<https://mall.industry.siemens.com/mall/en/en/Catalog/product?mfb=3VA9471-0WK40>

Service&Support (Manuals, Certificates, Characteristics, FAQs,...)

<https://support.industry.siemens.com/cs/ww/en/ps/3VA9471-0WK40>

Image database (product images, 2D dimension drawings, 3D models, device circuit diagrams, ...)

http://www.automation.siemens.com/bilddb/cax_en.aspx?mfb=3VA9471-0WK40

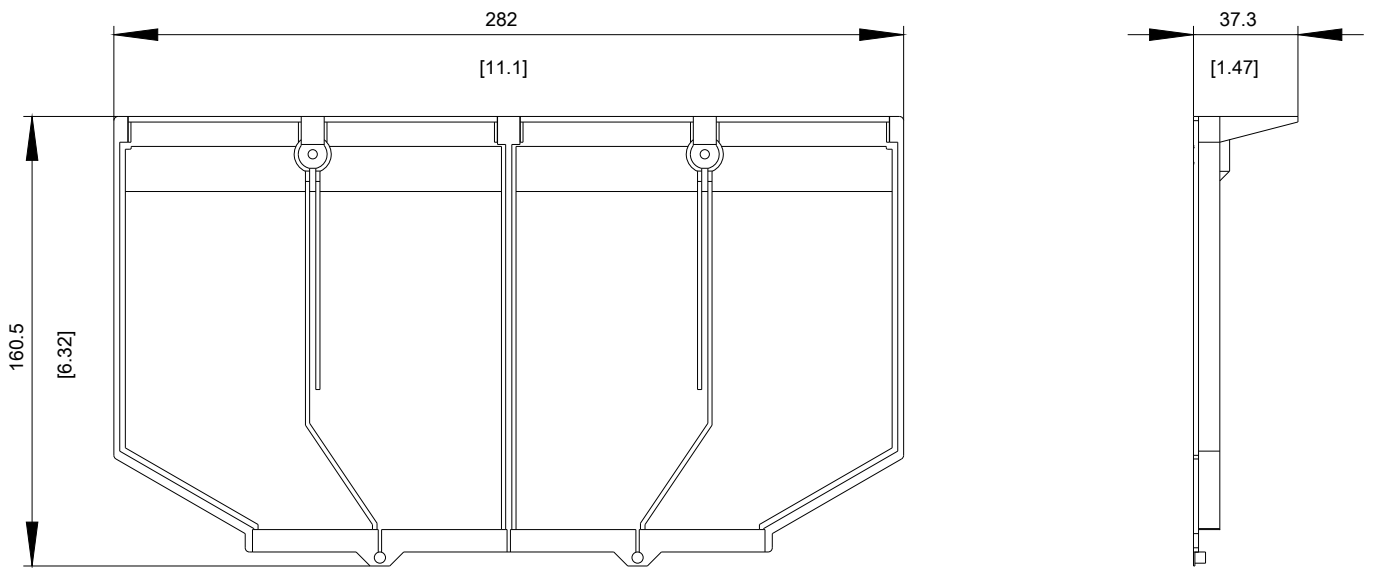

last modified:

08/28/2017