

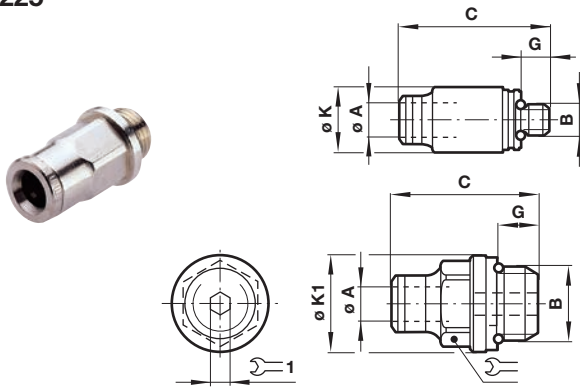



**Straight adaptor, BSP parallel  
10225**

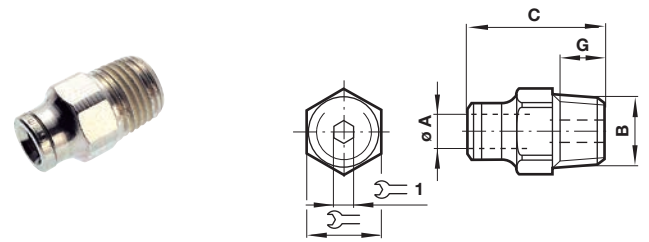

Ø A	B	C	G	Ø K	Ø K1		 1	Model
4	M3	21	2,5	9	-	-	1,5	102250403
4	M5	21,5	3,5	9	-	-	2,5	102250405
4	G1/8	19	5,5	-	14	10	3	102250418
4	G1/4	21	8	-	18	10	3	102250428
5	M5	23	3,5	10	-	-	2,5	102250505
5	G1/8	23,5	5,5	-	14	10	4	102250518
5	G1/4	22,5	8	-	18	12	4	102250528
6	M5	24	3,5	11	-	-	2,5	102250605
6	G1/8	25	5,5	-	14	11	4	102250618
6	G1/4	23,5	8	-	18	13	4	102250628
8	G1/8	26,5	5,5	-	14	13	5	102250818
8	G1/4	28	8	-	18	14	6	102250828
8	G3/8	24,5	9	-	12	17	6	102250838
8	G1/2	28,5	11	-	26	17	6	102250848
10	G1/8	32	5,5	-	14	17	5	102251018
10	G1/4	33,5	8	-	18	17	7	102251028
10	G3/8	32,5	9	-	22	19	8	102251038
10	G1/2	30,5	11	-	26	19	8	102251048
12	G1/4	36,5	8	-	18	22	7	102251228
12	G3/8	37,5	9	-	22	22	10	102251238
12	G1/2	34,5	11	-	26	22	10	102251248
14	G3/8	37,5	9	-	22	22	10	102251438
14	G1/2	38,5	11	-	26	22	10	102251448

**Straight adaptor, BSP taper  
10125**

 Dimensions in mm  
Projection/First angle

Ø A	B	C	G		 1	Model
4	R1/8	20,5	10	10	3	101250418
4	R1/4	23	11	14	3	101250428
5	R1/8	22,5	7,5	10	4	101250518
5	R1/4	23	11	14	4	101250528
6	R1/8	23	7,5	11	4	101250618
6	R1/4	25	11	14	4	101250628
8	R1/8	26,5	7,5	13	5	101250818
8	R1/4	28	11	14	6	101250828
8	R3/8	27	12,5	17	6	101250838
8	R1/2	29	16	22	6	101250848
10	R1/8	31,5	7,5	17	5	101251018
10	R1/4	34	11	17	7	101251028
10	R3/8	34	12,5	17	8	101251038
10	R1/2	33,5	16	22	8	101251048
12	R1/4	39	11	22	7	101251228
12	R3/8	39	12,5	22	10	101251238
12	R1/2	40	16	22	10	101251248
14	R3/8	39,5	12,5	22	10	101251438
14	R1/2	40	16	22	10	101251448

**Female straight adaptor, female parallel BSP  
10226**

Ø A	B	C	G		Model
4	M5	22,5	5	10	102260405
4	G1/8	24,5	7,5	13	102260418
4	G1/4	29	5	17	102260428
5	M5	23,5	7,5	10	102260505
5	G1/8	25,5	7,5	13	102260518
5	G1/4	29,5	7,5	17	102260528
6	G1/8	26	11	13	102260618
6	G1/4	30,5	11	17	102260628
8	G1/8	27	11	13	102260818
8	G1/4	31,5	11	17	102260828
10	G1/4	36,5	11	17	102261028
10	G3/8	39	11,5	19	102261038
12	G3/8	41	11,5	19	102261238
12	G1/2	44,5	15	24	102261248