

Datasheet - AZ 17-02ZK

Safety switch with separate actuator / AZ 17



- thermoplastic enclosure
- Small body
- 8 actuating planes
- 30 mm x 60 mm x 30 mm
- Multiple coding
- Double-insulated
- Long life
- High level of contact reliability with low voltages and currents
- Not sensitive to dirty conditions by virtue of patented roller system
- cable gland M16

(Minor differences between the printed image and the original product may exist!)

Ordering details

Product type description	AZ 17-02ZK
Article number	1121961
EAN code	4030661049694

Approval

Approval	 BG
	 USA/CAN
	 CCC

Classification

Standards	EN ISO 13849-1
B _{10d} Opener (NC)	2.000.000
Mission time	20 Years
notice	$MTTF_d = \frac{B_{10d}}{0,1 \times n_{op}}$ $n_{op} = \frac{d_{op} \times h_{op} \times 3600 \text{ s/h}}{t_{zyklus}}$

Global Properties

Product name	AZ 17
Standards	EN 60947-5-1, BG-GS-ET-15
Materials	
- Material of the housings	Plastic, glass-fibre reinforced thermoplastic, self-extinguishing
- Material of the contacts	Silver
Housing coating	None
Weight	85 g

Mechanical data

Design of electrical connection	IDC method of termination
Cable section	
- Min. Cable section	1 x 0,75 mm ²
- Max. Cable section	1 x 1 mm ²
Mechanical life	> 1.000.000 operations
higher Latching force (Y/N)	No
Latching force	5 N
Positive break force	17 N
positive break travel	11 mm
Max. Actuating speed	0,2 m/s

Ambient conditions

Protection class	IP67 to IEC/EN 60529
------------------	----------------------

Electrical data

Design of control element	Opener (NC)
Switching principle	Creep circuit element
Number of auxiliary contacts	0 piece
Number of safety contacts	2 piece
Rated impulse withstand voltage U _{imp}	4 kV
Rated insulation voltage U _i	250 V
Thermal test current I _{the}	10 A
Utilisation category	AC-15: 230 V / 4 A DC-13: 24 V / 4 A
Max. fuse rating	6 A gG D-fuse

ATEX

Explosion protection categories for gases	None
Explosion protected category for dusts	None

Dimensions

Dimensions of the sensor	
- Width of sensor	30 mm
- Height of sensor	85 mm
- Length of sensor	30 mm

notice

Individual coding available on request

This type termination (IDC) method enables simple connection of flexible conductors without the need for the use of conductor ferrules

Included in delivery

Actuators must be ordered separately.

Slot sealing plugs

Diagram

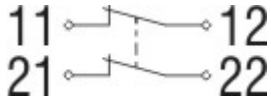



Note Diagram

 positive break NC contact

 active

 no active

 Normally-open contact

 Normally-closed contact

Switch travel diagram

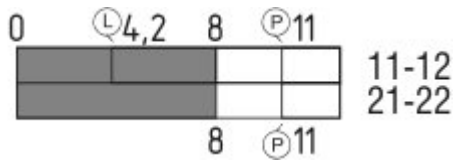



Notes Switch travel diagram

 Contact closed

 Contact open

 Setting range

 Break point

 Positive opening sequence/- angle

VS adjustable range of NO contact

VÖ adjustable range of NC contact

N after travel

Ordering suffix

The applicable ordering suffix is added at the end of the part number of the safety switch.

Order example: AZ 17-02ZK-1637

...-1637

0,3 µm gold-plated contacts

Ordering code

AZ 17-(1)Z(2)K-(3)-(4)-(5)

(1)

11 Normally open contact (NO) 1 / Opener (NC) 1

02 Opener (NC) 2

(2)

without Latching force 5 N

R Latching force 30 N

(3)

without cable gland M16

2243 Front cable entry

2243-1 Rear cable entry

ST Connector M12, 4-pole

(4)

1637 gold-plated contacts

(5)

5M 5 m Cable length

6M 6 m Cable length

Documents

Operating instructions and Declaration of conformity (br) 650 kB, 07.07.2010

http://127.0.0.1/Bilddata/AZ/Pdf/Az17/bedien/ace/br/mrl_az17-ace_br.pdf

Operating instructions and Declaration of conformity (fr) 647 kB, 02.06.2010

http://127.0.0.1/Bilddata/AZ/Pdf/Az17/bedien/fr/mrl_az17_fr.pdf

Operating instructions and Declaration of conformity (es) 641 kB, 02.06.2010

http://127.0.0.1/Bilddata/AZ/Pdf/Az17/bedien/es/mrl_az17_es.pdf

Operating instructions and Declaration of conformity (en) 721 kB, 02.06.2010

http://127.0.0.1/Bilddata/AZ/Pdf/Az17/bedien/en/mrl_az17_en.pdf

Operating instructions and Declaration of conformity (nl) 638 kB, 02.06.2010

http://127.0.0.1/Bilddata/AZ/Pdf/Az17/bedien/nl/mrl_az17_nl.pdf

Operating instructions and Declaration of conformity (de) 597 kB, 18.02.2011

http://127.0.0.1/Bilddata/AZ/Pdf/Az17/bedien/de/mrl_az17_de.pdf

Operating instructions and Declaration of conformity (it) 627 kB, 02.06.2010

http://127.0.0.1/Bilddata/AZ/Pdf/Az17/bedien/it/mrl_az17_it.pdf

Operating instructions and Declaration of conformity (jp) 1 MB, 17.11.2010

http://127.0.0.1/Bilddata/AZ/Pdf/Az17/bedien/jp/mrl_az17_jp.pdf

BG-test certificate (de) 552 kB, 28.02.2007

http://127.0.0.1/Bilddata/AZ/Pdf/Az17/baumuste/z_z17p01.pdf

BG-test certificate (en) 551 kB, 28.02.2007

http://127.0.0.1/Bilddata/AZ/Pdf/Az17/baumuste/z_z17p02.pdf

CCC certification (en) 746 kB, 12.12.2006

http://127.0.0.1/Bilddata/AZ/Pdf/Az15_16/zertifikat/q_175p02.pdf

CCC certification (cn) 730 kB, 12.12.2006

http://127.0.0.1/Bilddata/AZ/Pdf/Az15_16/zertifikat/q_175p03.pdf

Gost certification (ru) 1 MB, 21.06.2007

http://127.0.0.1/Bilddata/AZ/Pdf/Az15_16/zertifikat/q_az1p01.pdf

Images

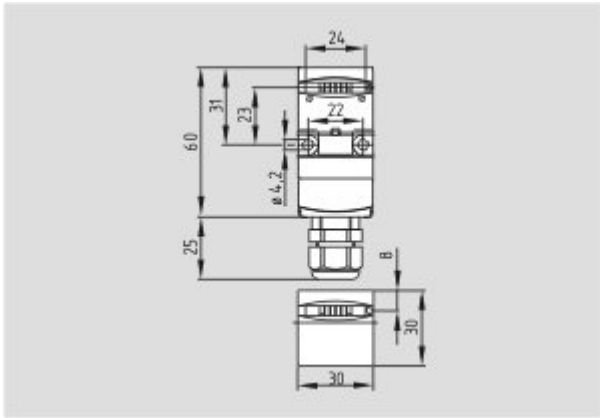

Dimensional drawing (basic component)

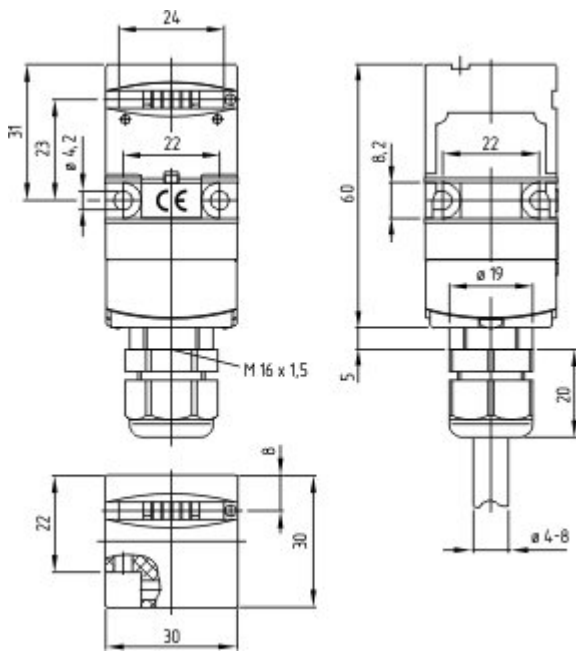

Dimensional drawing (basic component)

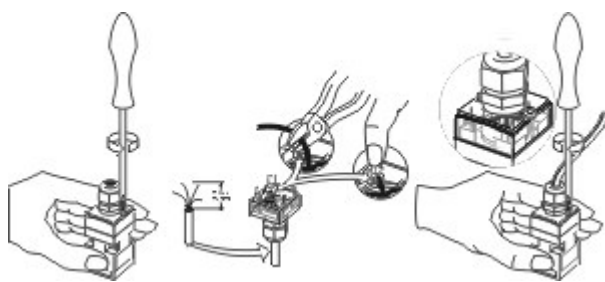

Configuration graphic

System components

Actuator



1122893 - AZ 17/170-B1

- Particularly suitable for sliding doors



1137406 - AZ 17/170-B1-2245

- Damps vibration on guard device



1122895 - AZ 17/170-B5

- Particularly suitable for hinged guards (front mounting)



1126060 - AZ 17-B6

- For very small actuating radii
- The direction of actuation can be selected by applicable insertion of the insert



1139788 - AZ 17/170-B11

- Particularly suitable for sliding doors



1139789 - AZ 17/170-B15

- Particularly suitable for hinged guards (front mounting)

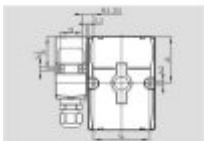

AZ 17-B25

- Ergonomic operation
- No supplementary door-handle required
- Door hinge on left-hand side (View point towards the hazardous area)
- No protruding actuator
- Actuator without handle
- Simple mounting
- Several door-handles available
- Possibility to mount the own handles using a default square screw (8 mm)

Accessories

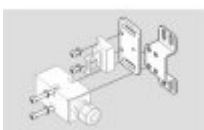

1150363 - Mounting set MS AZ 17 P

1149212 - Mounting set MS AZ 17 R/P

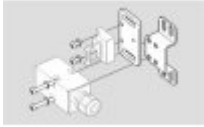

1208493 - AZM 170-B CENTERING GUIDE

- for AZ 17 and AZM 170

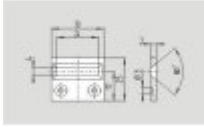

Mounting accessories



1135338 - TAMPERPROOF SCREWS M 5 x 12

- To mount the actuator
- Higher protection against tampering with interlock
- Protects against unauthorised removal of actuator
- Various lengths available



1135339 - TAMPERPROOF SCREWS M 5 x 16

- To mount the actuator
- Higher protection against tampering with interlock
- Protects against unauthorised removal of actuator
- Various lengths available



1135340 - TAMPERPROOF SCREWS M 5 x 20

- To mount the actuator
- Higher protection against tampering with interlock
- Protects against unauthorised removal of actuator
- Various lengths available

K.A. Schmersal GmbH, Möddinghofe 30, D-42279 Wuppertal

The data and values have been checked thoroughly. Technical modifications and errors excepted.

Generiert am 21.04.2011 - 10:01:04h Kasbase 1.4.7 DBI