



UNICASE

[Home Page](#)
[E-Mail Us](#)
[Catalogue PDF](#)
[Get a Catalogue](#)
[Get a Drawing](#)
[Get a Price](#)
[Get a Quote](#)
[Customising](#)
[IP Ratings](#)
[Colour Chart](#)
[Ordering Info](#)
[Order Form](#)
[Distributors](#)
 01489 583858

 01489 583836

FEATURES:

- Aluminium instrument enclosures
- Robust and versatile design
- Six standard models and four slimline models
- Simple and fast assembly
- Removable internal chassis
- PBC guide rails in the assembly extrusions
- Aluminium front and rear panels included
- Front panels recessed to protect controls
- Four push-in non-slip rubber feet included

MATERIAL:

- Aluminium

PROTECTION CLASS:

- IP 40 (Not rated)

FINISH:

- Powder epoxy polyester paint

STANDARD COLOURS:

- Light grey, RAL 7035

SUPPLY:

1. Top cover
2. Base cover
3. Assembly profile (x2)
4. Anodised aluminium front panel (x2)
5. Rubber foot (x4)
6. M3 x 8 mm (x16)

APPLICATIONS:

- Simple universal enclosures for measuring and control technology, feedback control, peripheral devices and interfaces, switchboxes, modems, medical field and laboratory technology.

 [Assembly Instructions](#)
 [Printable Page](#)

Standard Models



Slimline Models



Internal Chassis



Fast Assembly



Recessed Front Panel

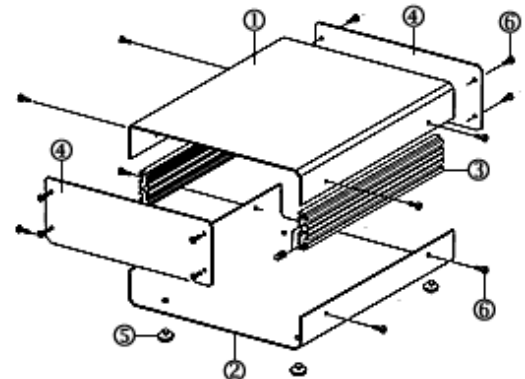

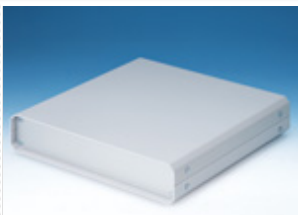

Part No. Slimline Models		Part No. Standard Models	Description	H	W	D	Drawings
M5511110	£		UNICASE SL1	50	130	180	PDF
M5512110	£		UNICASE SL2	50	185	250	PDF
M5513110	£		UNICASE SL3	50	250	250	PDF
M5514110	£		UNICASE SL4	50	250	300	PDF
		M5501110	£ UNICASE 1	65	185	180	PDF
		M5502110	£ UNICASE 2	90	260	250	PDF
		M5503110	£ UNICASE 3	110	350	250	PDF
		M5504110	£ UNICASE 4	134.5	261	300	PDF
		M5505110	£ UNICASE 5	134.5	367	300	PDF
		M5506110	£ UNICASE 6	134.5	474	300	PDF

DWG

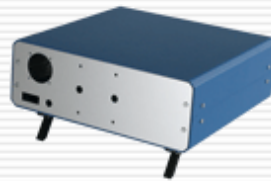

Customising

Tel: 01489 583858 Last Updated: 31-Oct-2007 ©METcase™ UK. All rights reserved.

FIRST ANGLE PROJECTION

Note: Subject to technical modifications without prior notice.
 Typographical and other errors do not justify any claim for damages.
 All dimensions should be verified using the actual case.

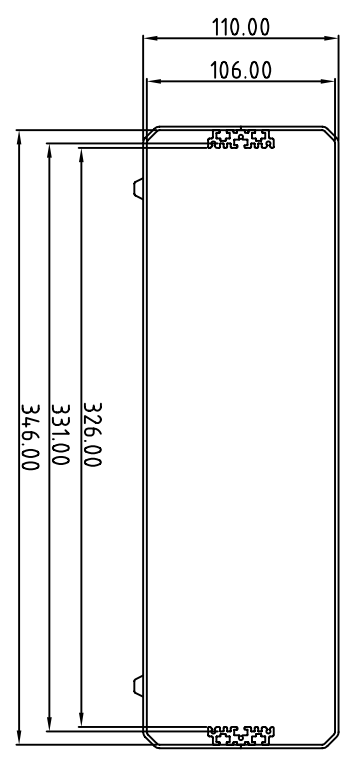
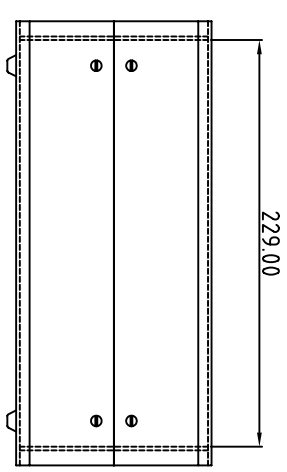
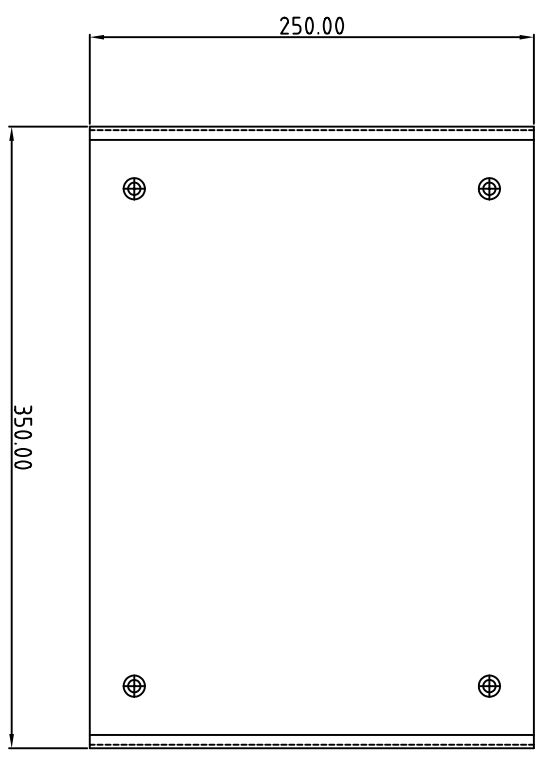
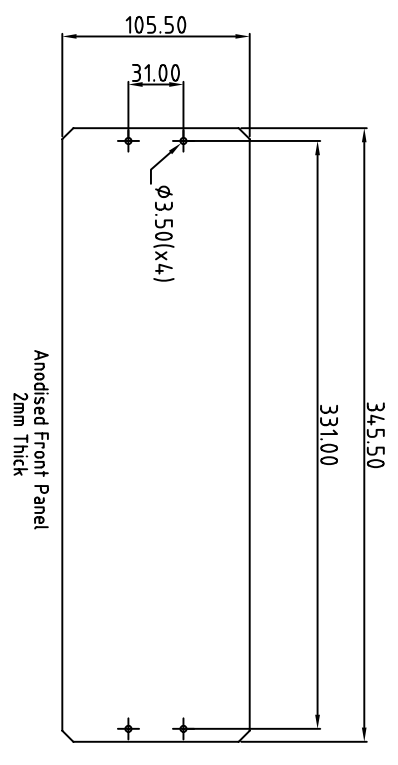

Modifications	Iss
	1

Tolerances unless otherwise stated:

- General tolerances ± 0.20
- Resultant tolerances between hole centers ± 0.15
- Tolerances on hole diameters ± 0.05
- Angles $\pm 0.5^\circ$
- Surface finish $32/\sqrt{\quad}$

Required Finish

Scale 1:4

Drawn by: IAN COX

Checked By:

Drawing Number: M5503110

Date drawn: August '05

DO NOT SCALE



METCASE ENCLOSURES
 Unit 3, Mitchell Close
 Segensworth East, Fareham,
 Hampshire, PO15 5SE, UK.

www.metcase.com

Part Name: UNICASE 3

Part Number: M5503110

Sheet 1 of 1

OKW ENCLOSURES LTD. DATE AS SHOWN. THIS DRAWING CONTAINS PROPRIETARY INFORMATION OF OKW ENCLOSURES LTD AND IS TENDERED SUBJECT TO THE FOLLOWING CONDITIONS. THE INFORMATION BE RETAINED IN CONFIDENCE. NOT BE REPRODUCED OR COPIED, AND NOT BE USED OR INCORPORATED IN ANY PRODUCT, UNLESS PERMISSION IS OBTAINED IN WRITING FROM OKW ENCLOSURES LTD.

A4