

Isolated Compact IGBT Gate Driver with DESAT

NCD57084, NCV57084

NCx57084 is a high current single channel IGBT gate driver with 2.5 kVrms internal galvanic isolation designed for high system efficiency and reliability in high power applications. The driver includes DESAT short circuit protection with soft turn off and fault reporting in a narrow body SOIC-8 package. NCx57084 accommodates wide range of input bias voltage and signal levels from 3.3 V to 20 V, and wide range of output bias voltage up to 30 V.

Features

- High Peak Output Current (+7A/-7 A)
- Low Output Impedance for Enhanced IGBT Driving
- Short Propagation Delays with Accurate Matching
- DESAT Protection with Programmable Delay
- Negative Voltage (Down to -9 V) Capability for DESAT
- IGBT Gate Clamping during Short Circuit
- IGBT Gate Active Pull Down
- Soft Turn Off During IGBT Short Circuit
- Tight UVLO Thresholds for Bias Flexibility
- Output Partial Pulse Avoidance During UVLO/DESAT (Restart)
- 3.3 V, 5 V, and 15 V Logic Input
- 2.5 kVrms Galvanic Isolation
- High Transient Immunity
- High Electromagnetic Immunity
- NCV Prefix for Automotive and Other Applications Requiring Unique Site and Control Change Requirements; AEC-Q100 Qualified and PPAP Capable
- This Device is Pb-Free, Halogen Free/BFR Free and is RoHS Compliant

Typical Applications

- Motor Control
- Automotive Applications
- Uninterruptible Power Supplies (UPS)
- Industrial Power Supplies
- HVAC
- Industrial Pumps and Fans



ON Semiconductor®

www.onsemi.com



**SOIC-8 NB
CASE 751-07**

MARKING DIAGRAM

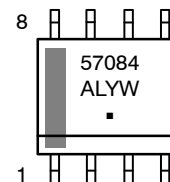

57084	= Specific Device Code
A	= Assembly Location
L	= Wafer Lot
Y	= Year
W	= Work Week
▪	= Pb-Free Package

PIN CONNECTIONS

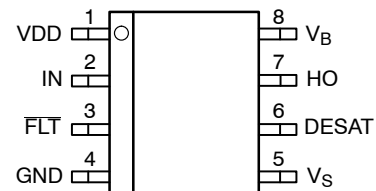

**NCx57084
x = D or V**

ORDERING INFORMATION

See detailed ordering and shipping information on page 10 of this data sheet.

NCD57084, NCV57084

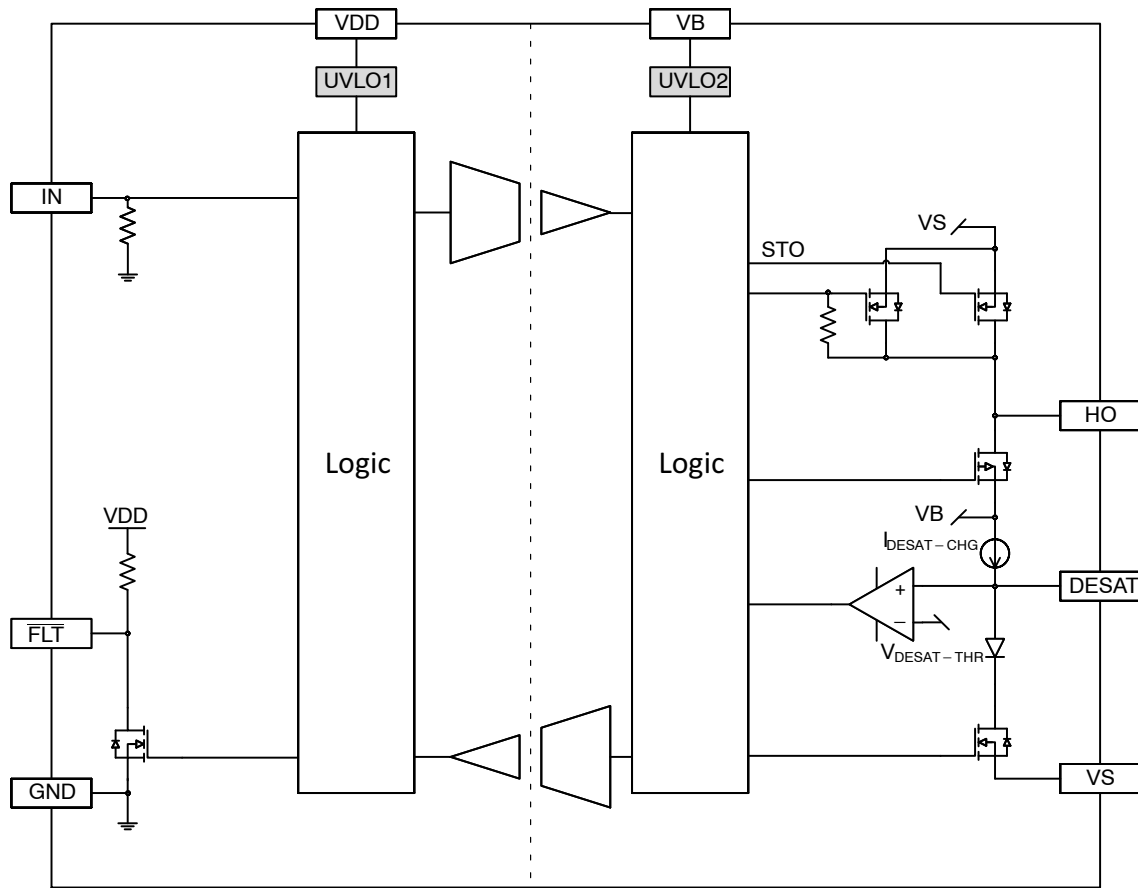

Figure 1. Simplified Block Diagram

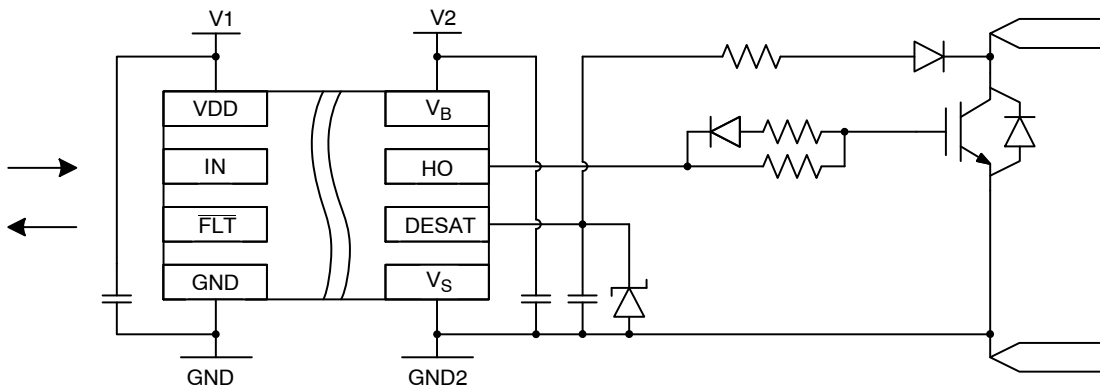

Figure 2. Simplified Application Schematics

NCD57084, NCV57084

FUNCTION DESCRIPTION

Pin Name	No.	I/O	Description
V _{DD}	1	Power	Input side power supply. A good quality bypassing capacitor is required from this pin to GND and should be placed close to the pins for best results. The under voltage lockout (UVLO1) circuit enables the device to operate at power on when a typical supply voltage higher than V _{UVLO1-OUT-ON} is present. Please see Figure 4 for more details.
IN	2	I	Non-inverted gate driver input. It is internally clamped to GND and has an equivalent pull-down resistor of 100 kΩ to ensure that output is low in the absence of an input signal.
FLT	3	O	Fault output (active low) that allows communication to the main controller that the driver has encountered a desaturation, or UVLO1, or UVLO2 condition and has deactivated the output. There is an internal 50 kΩ pull-up resistor connected to this pin. Multiple of them from different drivers can be "OR"ed together. FLT and HO will go high automatically after t _{MUTE} expires along with a rising edge of IN to avoid partial output pulse on HO. This is a feature called "Re-start".
GND	4	Power	Input side ground reference.
V _S	5	Power	Output side ground reference.
DESAT	6	I/O	Input for detecting the desaturation of IGBT due to a short circuit condition. An internal constant current source I _{DESAT-CHG} charging an external capacitor connected to this pin allows a programmable blanking delay every ON cycle before DESAT fault is processed, thus preventing false triggering. When the DESAT voltage goes up and reaches V _{DESAT-THR} , the output is driven low. Further, the $\overline{\text{FLT}}$ output is activated, please refer to Figure 6. $\overline{\text{FLT}}$ and HO will be kept low (including soft turn off time) at least for a period defined by t _{MUTE} .
HO	7	O	Driver output that provides the appropriate drive voltage and source/sink current to the IGBT/FET gate. HO is actively pulled low during start-up.
V _B	8	Power	Output side positive power supply. The operating range for this pin is from UVLO2 to its maximum allowed value. A good quality bypassing capacitor is required from this pin to V _S and should be placed close to the pins for best results. The under voltage lockout (UVLO2) circuit enables the device to operate at power on when a typical supply voltage higher than V _{UVLO2-OUT-ON} is present. Please see Figure 5 for more details.

SAFETY AND INSULATION RATINGS

Symbol	Parameter	Value	Unit
	Installation Classifications per DIN VDE 0110/1.89 Table 1 Rated Mains Voltage	< 150 V _{RMS}	I-IV
		< 300 V _{RMS}	I-IV
		< 450 V _{RMS}	I-IV
		< 600 V _{RMS}	I-IV
		< 1000 V _{RMS}	I-III
		Climatic Classification	40/100/21
	Pollution Degree (DIN VDE 0110/1.89)	2	
CTI	Comparative Tracking Index (DIN IEC 112/VDE 0303 Part 1)	600	
V _{PR}	Input-to-Output Test Voltage, Method b, V _{IORM} × 1.875 = V _{PR} , 100% Production Test with t _m = 1 s, Partial Discharge < 5 pC	2250	V _{PK}
V _{IORM}	Maximum Repetitive Peak Voltage	1200	V _{PK}
V _{IOWM}	Maximum Working Insulation Voltage	870	V _{RMS}
V _{IOTM}	Highest Allowable Over Voltage	4200	V _{PK}
E _{CR}	External Creepage	4.0	mm
E _{CL}	External Clearance	4.0	mm
DTI	Insulation Thickness	8.65	μm
T _{Case}	Safety Limit Values – Maximum Values in Failure; Case Temperature	150	°C
P _{S,INPUT}	Safety Limit Values – Maximum Values in Failure; Input Power	132	mW
P _{S,OUTPUT}	Safety Limit Values – Maximum Values in Failure; Output Power	1128	mW
R _{IO}	Insulation Resistance at TS, V _{IO} = 500 V	10 ⁹	Ω

ISOLATION CHARACTERISTICS

Symbol	Parameter	Conditions	Value	Unit
V _{ISO} , INPUT- OUTPUT	Input-Output Isolation Voltage	T _A = 25°C, Relative Humidity < 50%, t = 1.0 minute, I _{I-O} < 30 μA, 50 Hz (Notes 1, 2, 3)	2500	V _{RMS}
R _{ISO}	Isolation Resistance	V _{I-O} = 500 V (Note 1)	10 ¹¹	Ω

1. Device is considered a two-terminal device: pins 1 to 4 are shorted together and pins 5 to 8 are shorted together.
2. 2,500 VRMS for 1-minute duration is equivalent to 3,000 VRMS for 1-second duration.
3. The input-output isolation voltage is a dielectric voltage rating per UL1577. It should not be regarded as an input-output continuous voltage rating. For the continuous working voltage rating, refer to equipment-level safety specification or DIN VDE V 0884-11 Safety and Insulation Ratings Table.

NCD57084, NCV57084

ABSOLUTE MAXIMUM RATINGS (Note 4) Over operating free-air temperature range unless otherwise noted.

Symbol	Parameter	Minimum	Maximum	Unit
$V_{DD} - GND$	Supply Voltage, Input Side	-0.3	22	V
$V_B - V_S$	Supply Voltage, Output Side	-0.3	32	V
$V_{HO} - V_S$	Gate-driver Output Voltage	-0.3	$V_{BS} + 0.3$	V
I_{PK-SRC}	Gate-driver Output Sourcing Peak Current (maximum pulse width = 10 μ s, maximum duty cycle = 0.2%, $V_D - V_S = 15$ V)	-	7	A
I_{PK-SNK}	Gate-driver Output Sinking Peak Current (maximum pulse width = 10 μ s, maximum duty cycle = 0.2%, $V_D - V_S = 15$ V)	-	7.5	A
$V_{IN} - GND$	Voltage at IN, FLT	-0.3	$V_{DD} + 0.3$	V
I_{FLT}	Output current of FLT	-	10	mA
$V_{DESAT} - V_S$	Voltage at DESAT (Note 5)	-9	$V_{BS} + 0.3$	V
PD	Power Dissipation (Note 6)	-	1123	mW
ESD _{HBM}	ESD Capability, Human Body Model (Note 7)	-	± 2	kV
ESD _{CDM}	ESD Capability, Charged Device Model (Note 7)	-	± 2	kV
MSL	Moisture Sensitivity Level	-	1	-
$T_J(max)$	Maximum Junction Temperature	-40	150	$^{\circ}C$
T_{STG}	Storage Temperature Range	-65	150	$^{\circ}C$
T_{SLD}	Lead Temperature Soldering Reflow, Pb-Free (Note 8)	-	260	$^{\circ}C$

Stresses exceeding those listed in the Maximum Ratings table may damage the device. If any of these limits are exceeded, device functionality should not be assumed, damage may occur and reliability may be affected.

4. Refer to ELECTRICAL CHARACTERISTICS and APPLICATION INFORMATION for Safe Operating Area.

5. The minimum value is verified by characterization with a single pulse of 1.5 mA for 300 μ s.

6. The value is estimated for ambient temperature 25 $^{\circ}C$ and junction temperature 150 $^{\circ}C$, 650 mm², 1 oz copper, 2 surface layers and 2 internal power plane layers. Power dissipation is affected by the PCB design and ambient temperature.

7. This device series incorporates ESD protection and is tested by the following methods:

ESD Human Body Model tested per AEC-Q100-002 (EIA/JESD22-A114).

ESD Charged Device Model tested per AEC-Q100-011 (EIA/JESD22-C101).

Latchup Current Maximum Rating: ≤ 100 mA per JEDEC standard: JESD78, 125 $^{\circ}C$.

8. For information, please refer to our Soldering and Mounting Techniques Reference Manual, SOLDERRM/D.

THERMAL CHARACTERISTICS (Note 9, 10)

Symbol	Parameter	Conditions	Value	Unit
$R_{\theta JA}$	Thermal Resistance, Junction-to-Air	100 mm ² , 1 oz Copper, 1 Surface Layer	179	$^{\circ}C/W$
		100 mm ² , 1 oz Copper, 2 Surface Layers and 2 Internal Power Plane Layers	110	

9. Refer to ELECTRICAL CHARACTERISTICS and APPLICATION INFORMATION for Safe Operating Area.

10. Values based on copper area of 100 mm² (or 0.16 in²) of 1 oz copper thickness and FR4 PCB substrate.

OPERATING RANGES (Note 11)

Symbol	Parameter	Min	Max	Unit
V_{DD-GND}	Supply Voltage, Input Side	UVLO1	20	V
$V_B - V_S$	Supply Voltage, Output Side	UVLO2	30	V
V_{IN}	Logic Input Voltage at IN	GND	V_{DD}	V
$ dV_{ISO}/dt $	Common Mode Transient Immunity	100	-	kV/ μ s
T_A	Ambient Temperature	-40	125	$^{\circ}C$

Functional operation above the stresses listed in the Recommended Operating Ranges is not implied. Extended exposure to stresses beyond the Recommended Operating Ranges limits may affect device reliability.

11. Refer to ELECTRICAL CHARACTERISTICS and APPLICATION INFORMATION for Safe Operating Area.

NCD57084, NCV57084

ELECTRICAL CHARACTERISTICS $V_{DD} = 5\text{ V}$, $V_{BS} = 15\text{ V}$.

For typical values $T_A = 25^\circ\text{C}$, for min/max values, T_A is the operating ambient temperature range that applies, unless otherwise noted.

Symbol	Parameter	Test Conditions	Min	Typ	Max	Unit
VOLTAGE SUPPLY						
$V_{UVLO1-OUT-ON}$	UVLO1 Output Enabled		-	-	3.1	V
$V_{UVLO1-OUT-OFF}$	UVLO1 Output Disabled		2.4	-	-	V
$V_{UVLO1-HYST}$	UVLO1 Hysteresis		0.1	-	-	V
$V_{UVLO2-OUT-ON}$	UVLO2 Output Enabled		12.4	12.9	13.4	V
$V_{UVLO2-OUT-OFF}$	UVLO2 Output Disabled		11.5	12	12.5	V
$V_{UVLO2-HYST}$	UVLO2 Hysteresis		0.7	1	-	V
$I_{DD-0-3.3}$	Input Supply Quiescent Current	IN = Low, $V_{DD} = 3.3\text{ V}$, $\overline{FLT} = \text{Hig}$	-	-	2	mA
I_{DD-0-5}		IN = Low, $V_{DD} = 5\text{ V}$, $\overline{FLT} = \text{High}$	-	-	2	mA
$I_{DD-0-15}$		IN = Low, $V_{DD} = 15\text{ V}$, $\overline{FLT} = \text{High}$	-	-	2	mA
$I_{DD-100-5}$		IN = High, $V_{DD} = 5\text{ V}$, $\overline{FLT} = \text{High}$	-	-	6	mA
I_{BS-0}	Output Supply Quiescent Current	IN = Low, no load	-	-	4	mA
I_{BS-100}		IN = High, no load	-	-	6	mA

LOGIC INPUT AND OUTPUT

V_{IL}	Low Input Voltage (Note 12)				$0.3 \times V_{DD}$	V
V_{IH}	High Input Voltage (Note 12)		$0.7 \times V_{DD}$			V
$V_{IN-HYST}$	Input Hysteresis Voltage (Note 12)			$0.15 \times V_{DD}$		V
I_{IN}	Input Current	$V_{IN} = V_{DD}$		50		μA
I_{FLT-L}	FLT Pull-up Current (50 k Ω pull-up resistor)	$V_{FLT} = \text{Low}$	-	100	-	μA
V_{FLT-L}	FLT Low Level Output Voltage	$I_{FLT} = 5\text{ mA}$	-	-	0.3	V
t_{MIN1}	Input Pulse Width of IN for No Response at Output		-	-	10	ns
t_{MIN2}	Input Pulse Width of IN for Guaranteed Response at Output		40	-	-	ns

DRIVER OUTPUT

V_{HOL1}	Output Low State ($V_{HO} - V_S$)	$I_{SNK} = 200\text{ mA}$	-	0.1	0.22	V
V_{HOL2}		$I_{SNK} = 1.0\text{ A}$, $T_A = 25^\circ\text{C}$	-	0.4	1	
V_{HOH1}	Output High State ($V_B - V_{HO}$)	$I_{SRC} = 200\text{ mA}$	-	0.2	0.35	V
V_{HOH2}		$I_{SRC} = 1.0\text{ A}$, $T_A = 25^\circ\text{C}$	-	0.6	1.7	
$I_{PK-SNK1}$	Peak Driver Current, Sink (Note 13)		-	7.5	-	A
$I_{PK-SNK2}$	Peak Driver Current, Sink (Note 13)	$V_{HO} = 9\text{ V}$ (near IGBT Miller Plateau)	-	7	-	A
$I_{PK-SRC1}$	Peak Driver Current, Source (Note 13)		-	7	-	A
$I_{PK-SRC2}$	Peak Driver Current, Source (Note 13)	$V_{HO} = 9\text{ V}$ (near IGBT Miller Plateau)	-	5	-	A

DESAT PROTECTION

$V_{DESAT-THR}$	DESAT Threshold Voltage		8.4	9	9.5	V
$V_{DESAT-NEG}$	DESAT Negative Voltage	$I_{DESAT} = 1.5\text{ mA}$	-	-8	-	V
$I_{DESAT-CHG}$	Blanking Charge Current	$V_{DESAT} = 7\text{ V}$	0.45	0.5	0.55	mA
$I_{DESAT-DIS}$	Blanking Discharge Current		-	50	-	mA

NCD57084, NCV57084

ELECTRICAL CHARACTERISTICS (continued) $V_{DD} = 5\text{ V}$, $V_{BS} = 15\text{ V}$.

For typical values $T_A = 25^\circ\text{C}$, for min/max values, T_A is the operating ambient temperature range that applies, unless otherwise noted.

Symbol	Parameter	Test Conditions	Min	Typ	Max	Unit
IGBT SHORT CIRCUIT CLAMPING						
V_{CLP-HO}	IGBT Short Circuit Clamping ($V_{HO} - V_B$)	IN = High, $I_{HO} = 500\text{ mA}$, $t_{CLP} = 10\text{ }\mu\text{s}$	–	0.7	1.5	V
DYNAMIC CHARACTERISTICS						
t_{PD-ON}	IN to HO High Propagation Delay	$C_{LOAD} = 10\text{ nF}$ V_{IH} to 10% of HO Change for $PW > 150\text{ ns}$	40	60	90	ns
t_{PD-OFF}	IN to HO Low Propagation Delay	$C_{LOAD} = 10\text{ nF}$ V_{IL} to 90% of HO Change for $PW > 150\text{ ns}$	40	60	90	ns
$t_{DISTORT}$	Propagation Delay Distortion (= $t_{PD-ON} - t_{PD-OFF}$)	$T_A = 25^\circ\text{C}$, $PW > 150\text{ ns}$	–	0	–	ns
		$T_A = -40^\circ\text{C}$ to 125°C , $PW > 150\text{ ns}$	–25	–	25	
$t_{DISTORT_TOT}$	Prop Delay Distortion between Parts	$PW > 150\text{ ns}$	–30	0	30	ns
t_{RISE}	Rise Time (see Figure 3) (Note 13)	$C_{LOAD} = 1\text{ nF}$, 10% to 90% of HO Change	–	10	–	ns
t_{FALL}	Fall Time (see Figure 3) (Note 13)	$C_{LOAD} = 1\text{ nF}$, 90% to 10% of HO Change	–	15	–	ns
t_{LEB}	DESAT Leading Edge Blanking Time (See Figure 6)		200	450	700	ns
t_{FILTER}	DESAT Threshold Filtering Time (see Figure 6)		–	320	600	ns
t_{STO}	Soft Turn Off Time (see Figure 6)	$C_{LOAD} = 10\text{ nF}$, $R_G = 10\text{ }\Omega$	1.2	1.8	3	μs
t_{FLT}	Delay after t_{FILTER} to FLT Low		100	450	700	ns
t_{FLT1}	Delay from $V_{UVLO1-OUT-OFF}$ Triggered to FLT Low		–	1.5	–	μs
t_{FLT2}	Delay from t_{UVF2} to FLT Low		–	2.4	–	μs
t_{MUTE}	IN Mute Time after t_{FILTER} , or $UVLO1$, $UVLO2$ Triggered		20	–	–	μs
t_{UVR1}	Delay from $V_{UVLO1-OUT-ON}$ Triggered to HO High	(Note 13)	–	770	–	ns
t_{UVF1}	Delay from $V_{UVLO1-OUT-OFF}$ Triggered to HO Low	(Note 13)	–	1500	–	ns
t_{UVR2}	Delay from $V_{UVLO2-OUT-ON}$ Triggered to HO High	(Note 13)	–	1000	–	ns
t_{UVF2}	Delay from $V_{UVLO2-OUT-OFF}$ Triggered to HO Low (see Figure 5)	(Note 13)	–	1000	–	ns

Product parametric performance is indicated in the Electrical Characteristics for the listed test conditions, unless otherwise noted. Product performance may not be indicated by the Electrical Characteristics if operated under different conditions.

12. Table values are valid for 3.3 V and 5 V V_{DD} , for higher V_{DD} voltages, the threshold values are maintained at the 5 V V_{DD} levels.

13. Values based on design and/or characterization.

NCD57084, NCV57084

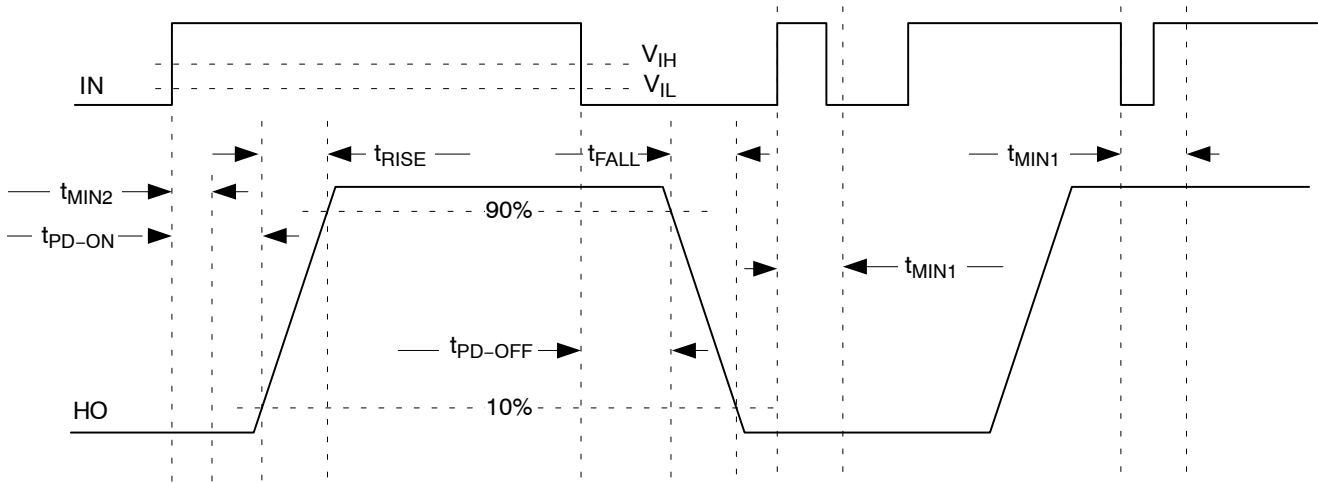

Figure 3. Propagation Delay, Rise and Fall Time

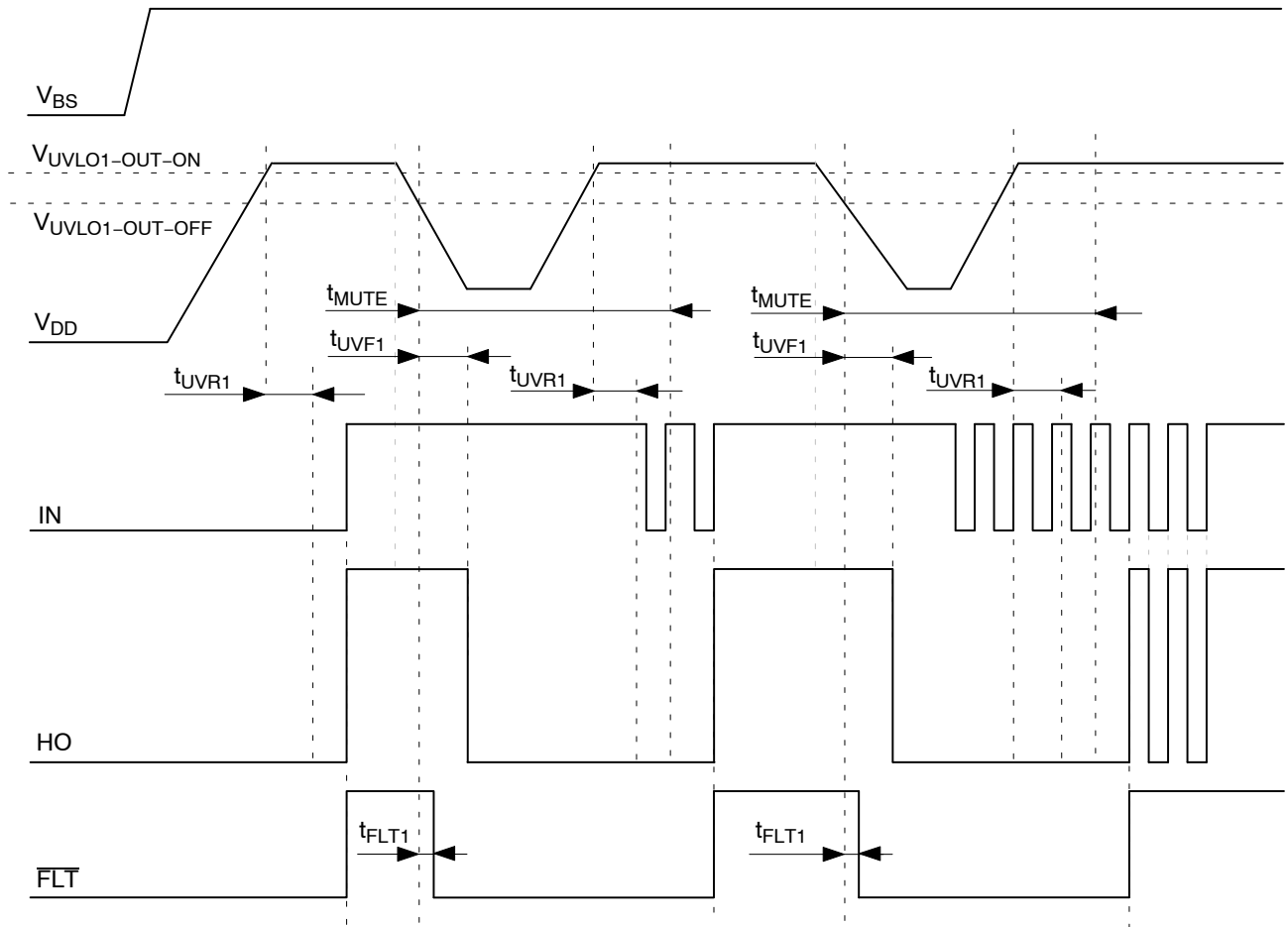

Figure 4. UVLO1 Waveform

NCD57084, NCV57084

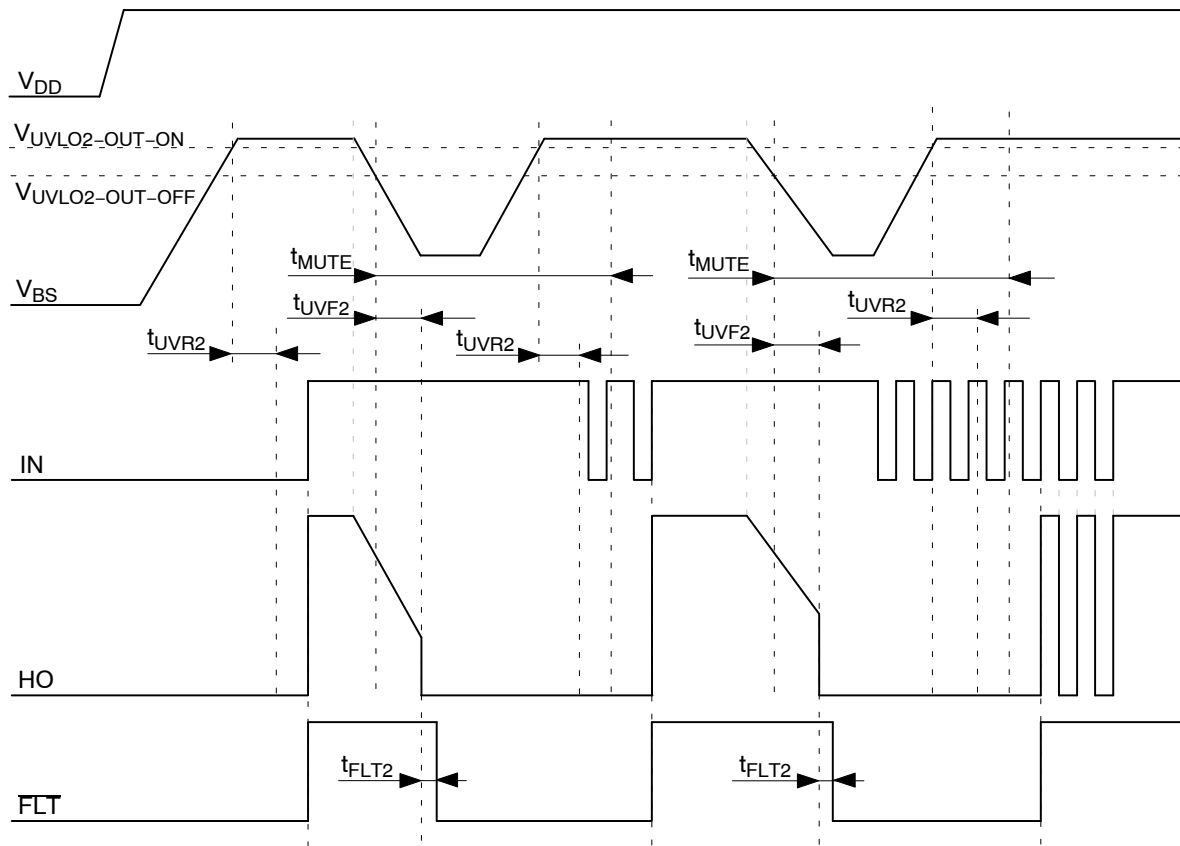

Figure 5. UVLO2 Waveform

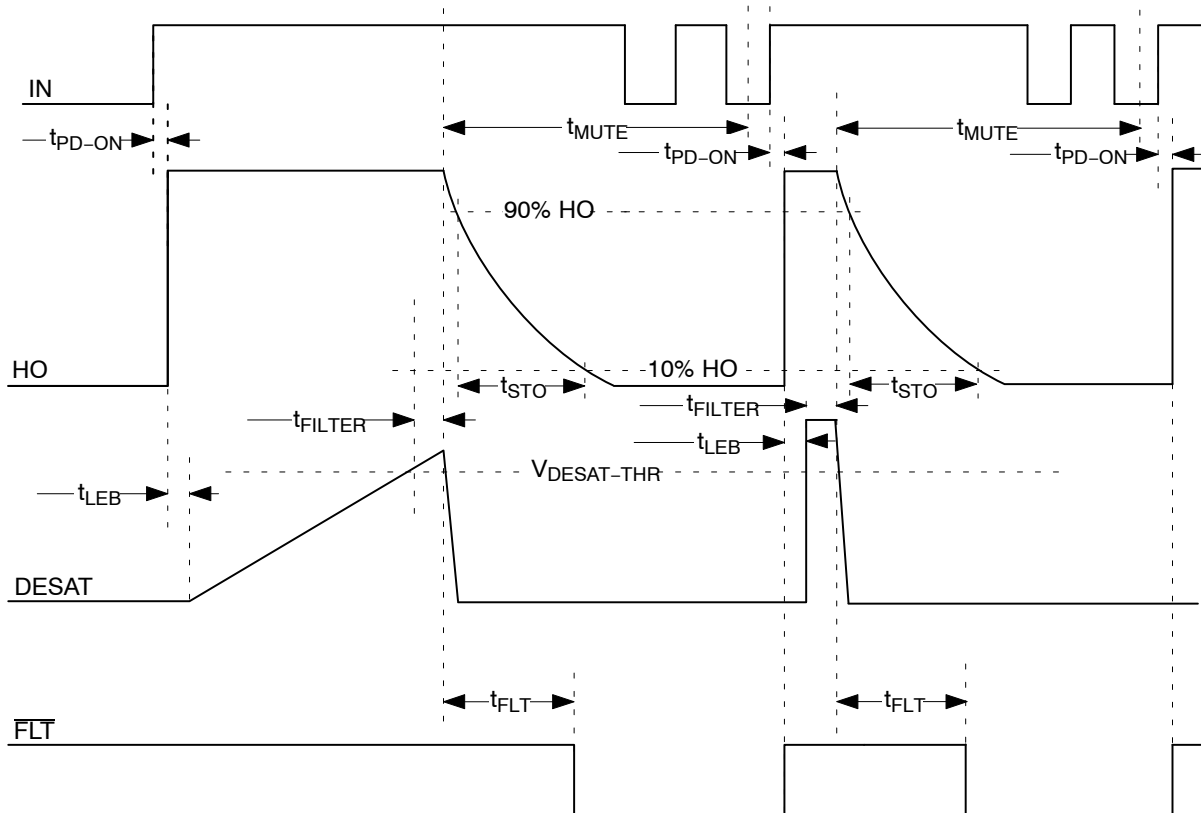

Figure 6. DESAT Response Waveform

NCD57084, NCV57084

TRUTH TABLE

IN	UVLO1	UVLO2	DESAT	HO	FLT	Notes
L	Inactive	Inactive	L	L	L	Initial condition after power up V_{DD} and V_{BS}
\nearrow	Inactive	Inactive	L	\nearrow	\nearrow	Initial condition – IN First Rising edge
H	Inactive	Inactive	L	H	H	Normal Operation – Output High
\searrow	Inactive	Inactive	L	\searrow	H	Normal Operation – Turn off Output
L	Inactive	Inactive	L	L	H	Normal Operation – Output Low
X	Active	Inactive	X	L	L	UVLO1 Activated – FLT Low (t_{FLT1}), Output Low
\nearrow	Inactive	Inactive	L	\nearrow	\nearrow	FLT reset, UVLO1 conditions disappear
X	Inactive	Active	X	L	L	UVLO2 Activated – FLT Low (t_{FLT1}), Output Low
\nearrow	Inactive	Inactive	L	\nearrow	\nearrow	FLT reset, UVLO2 conditions disappear
H	Inactive	Inactive	H ($>t_{FILTER}$)	L	L	DESAT Activated – FLT Low (t_{FLT}), Output Low
\nearrow	Inactive	Inactive	L	\nearrow	\nearrow	FLT reset, DESAT conditions disappear

ORDERING INFORMATION

Device	Package	Shipping [†]
NCD57084DR2G	SOIC–8 Narrow Body, (Pb–Free)	2500 / Tape & Reel
NCV57084DR2G	SOIC–8 Narrow Body, (Pb–Free)	2500 / Tape & Reel

[†]For information on tape and reel specifications, including part orientation and tape sizes, please refer to our Tape and Reel Packaging Specifications Brochure, BRD8011/D.

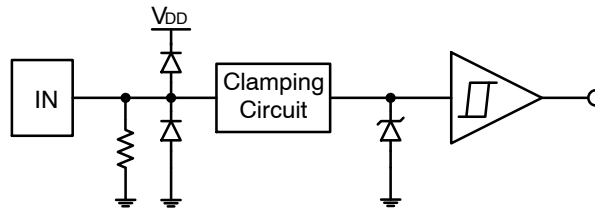

Figure 7. Input Pin Structure

TYPICAL CHARACTERISTICS

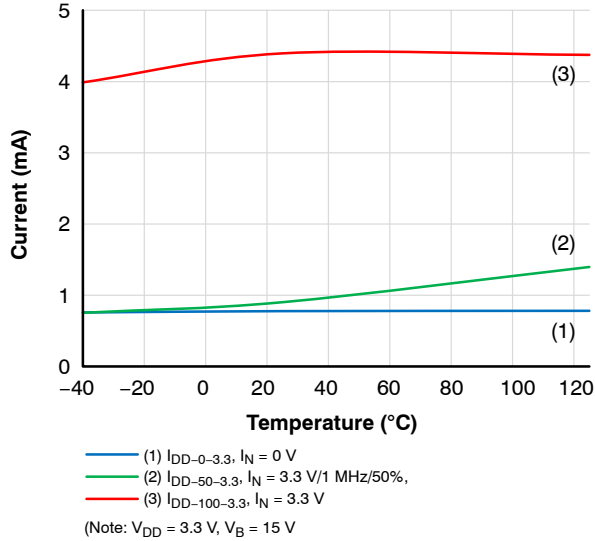

Figure 8. I_{DD} Supply Current, $V_{DD} = 3.3$ V

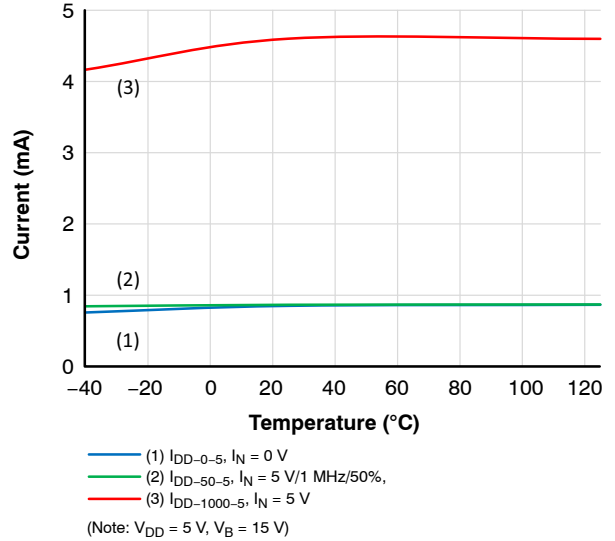

Figure 9. I_{DD} Supply Current, $V_{BS} = 5$ V

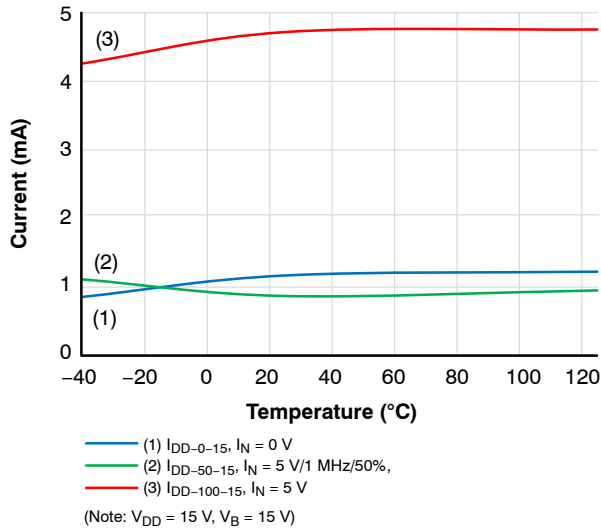

Figure 10. I_{DD} Supply Current, $V_{DD} = 15$ V

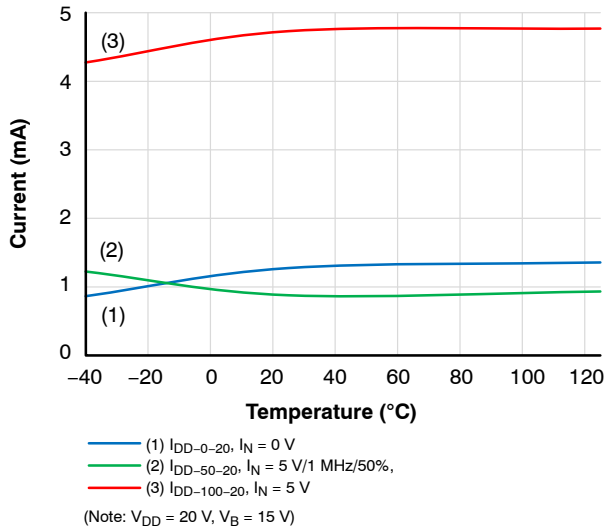

Figure 11. I_{DD} Supply Current, $V_{DD} = 20$ V

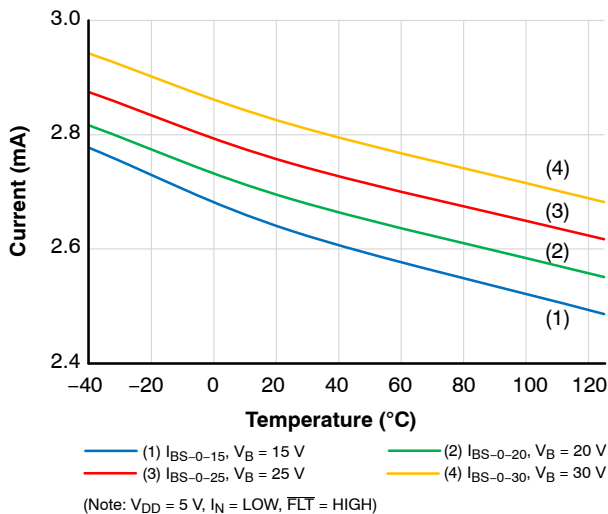

Figure 12. I_{BS} Supply Current, $V_{DD} = 5$ V

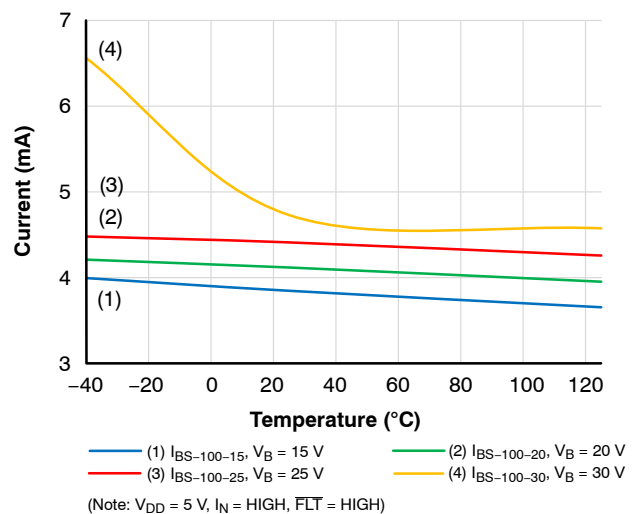
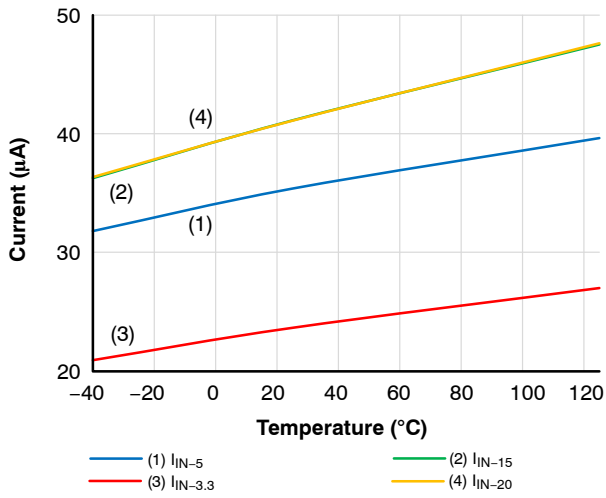

Figure 13. I_{BS} Supply Current, $V_{DD} = 5$ V

NCD57084, NCV57084



(Note: $V_{IN} = V_{DD}$, $V_{BS} = 15$ V)

Figure 14. Input Current - Logic "1"

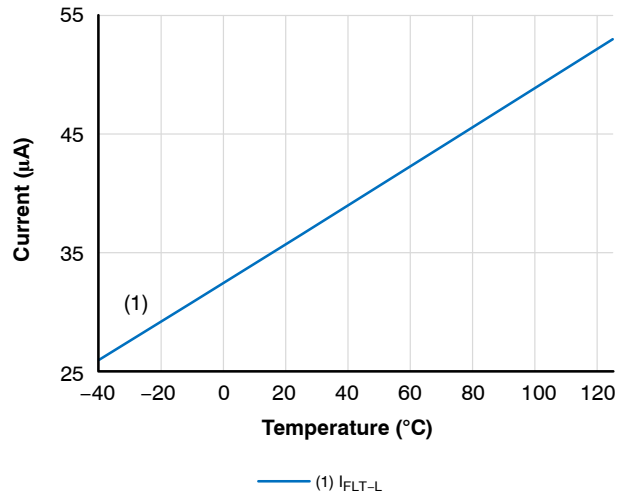

(Note: FLT = LOW, $V_{DD} = 5$ V)

Figure 15. FLT = Pull-up Current

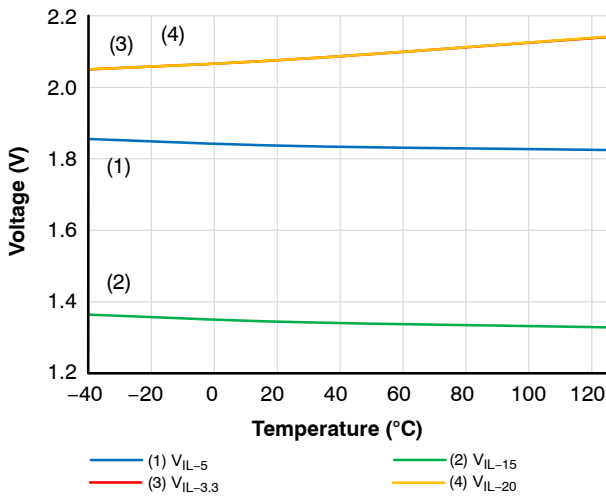

(Note: $V_{BS} = 15$ V)

Figure 16. Low Input Voltage

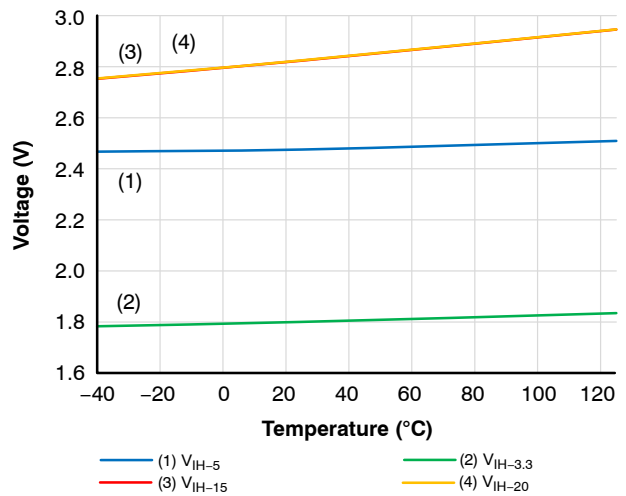

(Note: $V_{BS} = 15$ V)

Figure 17. High Input Voltage

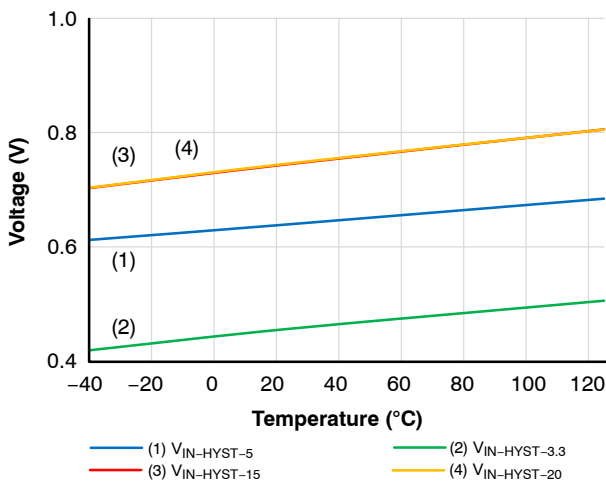

(Note: $V_{BS} = 15$ V)

Figure 18. Input Hysteresis Voltage

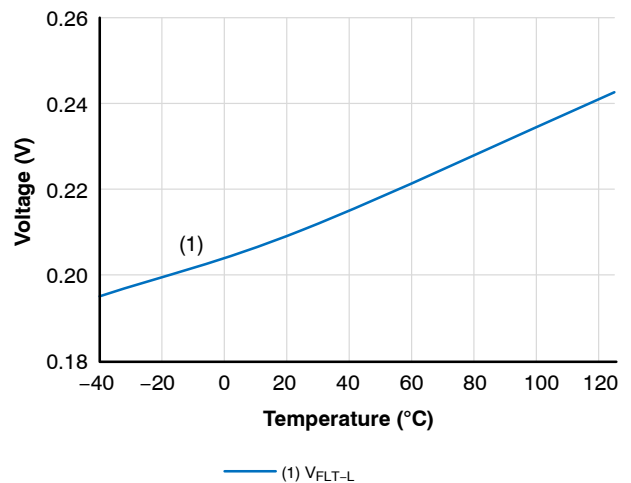

(Note: $I_{FLT} = 5$ mA)

Figure 19. FLT Low Level Output Voltage

NCD57084, NCV57084

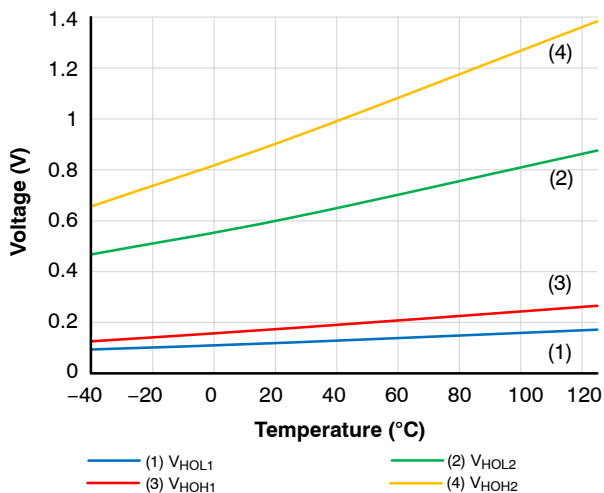

(Note: $V_{DD} = 5\text{ V}$, $V_{BS} = 15\text{ V}$)

Figure 20. Output Voltage

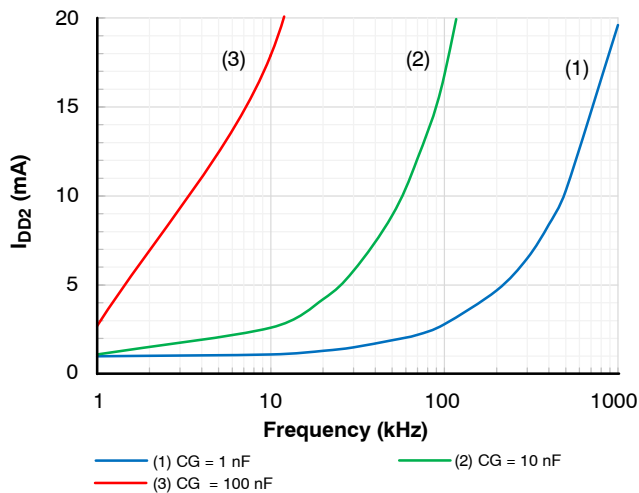

Figure 21. I_{BS} vs Switching Frequency

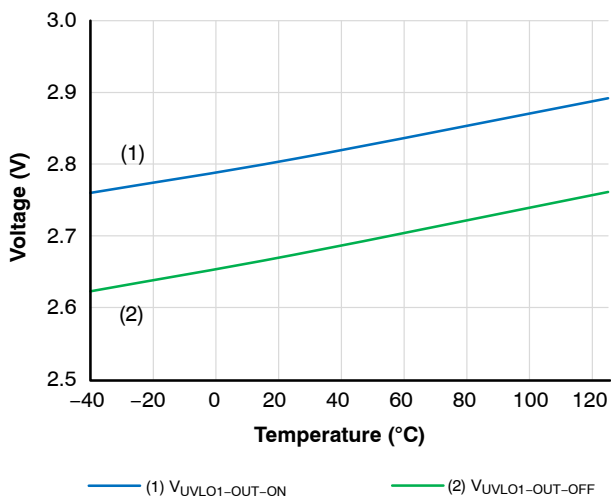

Figure 22. UVLO1 Threshold Voltage

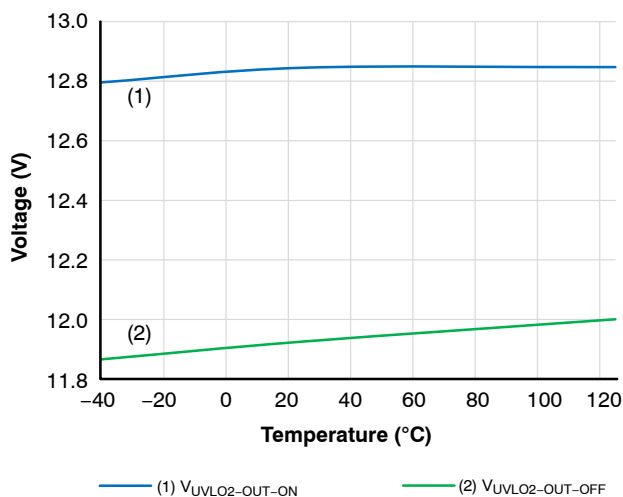

Figure 23. UVLO2 Threshold Voltage

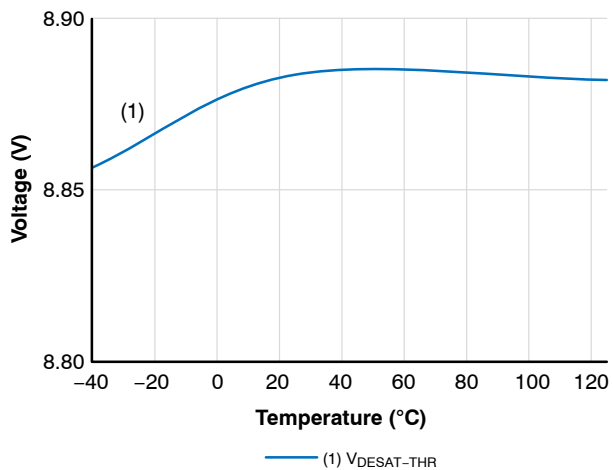

Figure 24. DESAT Threshold Voltage

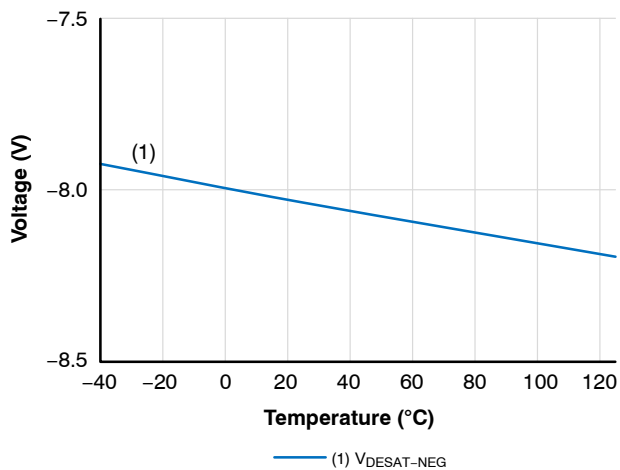

Figure 25. DESAT Negative Voltage

NCD57084, NCV57084

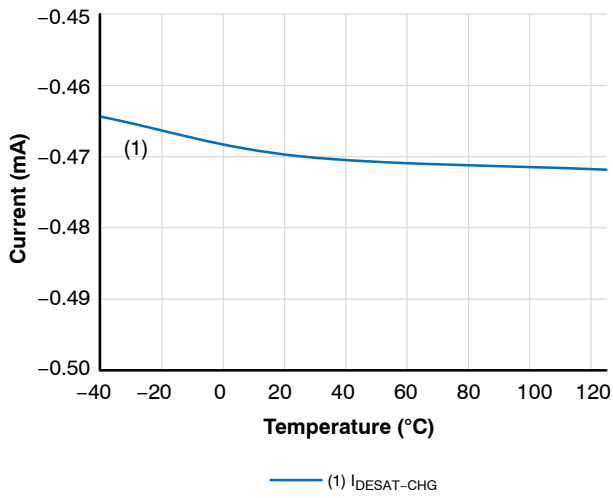

Figure 26. DESAT Blanking Charge Current

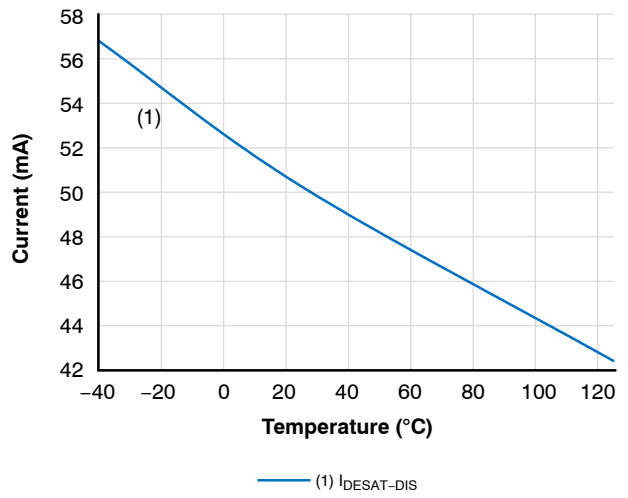

Figure 27. DESAT Blanking Discharge Current

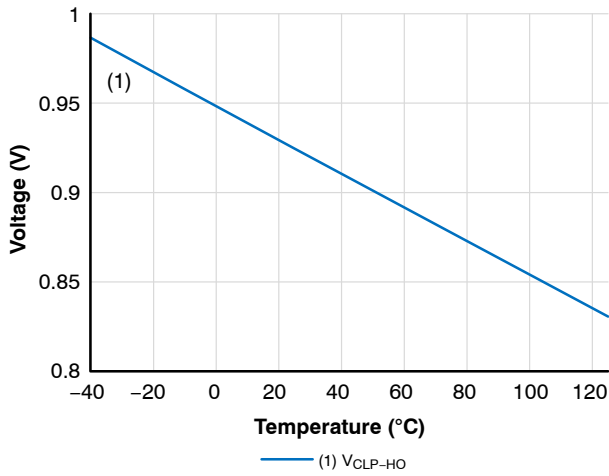
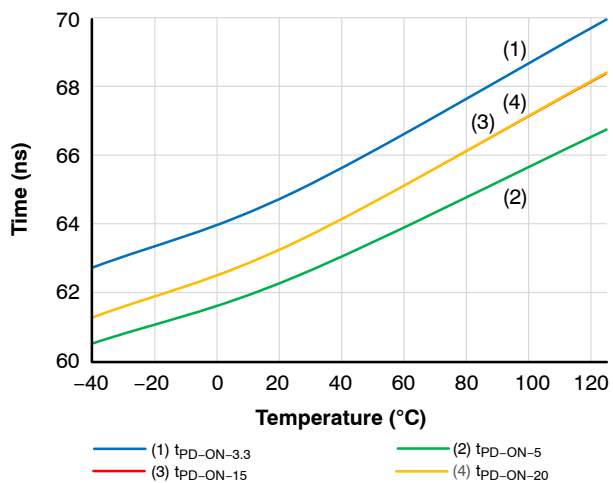
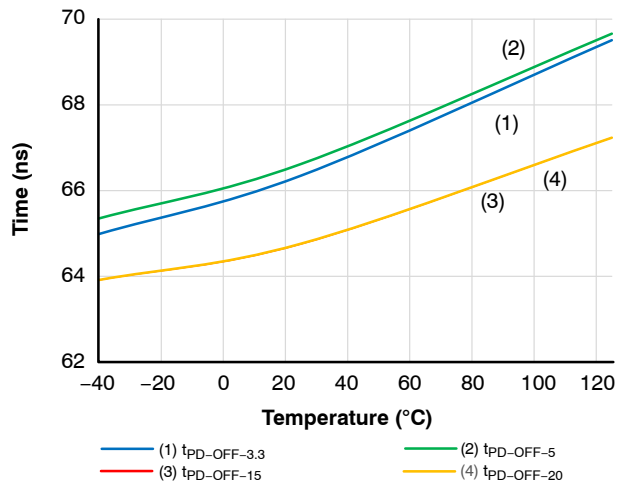

Figure 28. IGBT Short Circuit Clamping Voltage



(Note: $C_{LOAD} = 10 \text{ nF}$, $V_{BS} = 15 \text{ V}$)

Figure 29. High Propagation Delay



(Note: $C_{LOAD} = 10 \text{ nF}$, $V_{BS} = 15 \text{ V}$)

Figure 30. Low Propagation Delay

NCD57084, NCV57084

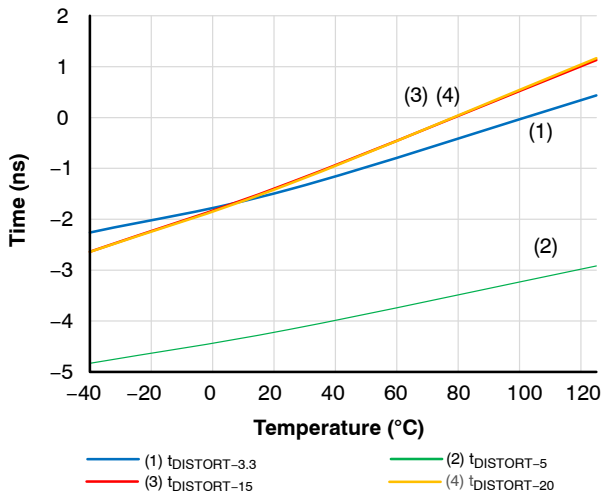

(Note: $V_{BS} = 15\text{ V}$)

Figure 31. Propagation Delay Distortion

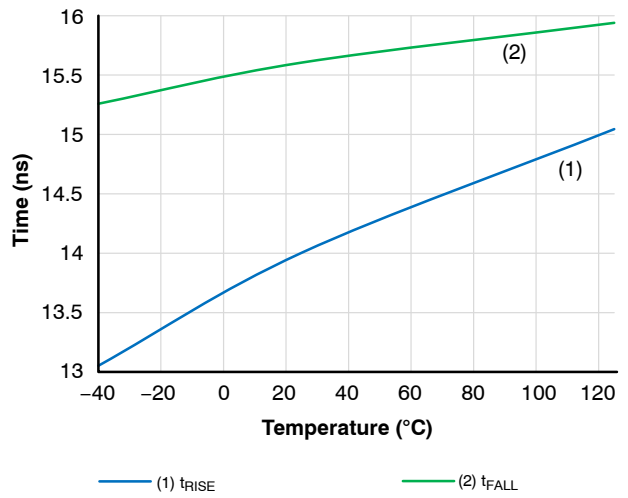

(Note: $C_{LOAD} = 1\text{ nF}$, $V_{BS} = 15\text{ V}$)

Figure 32. Rise / Fall Time

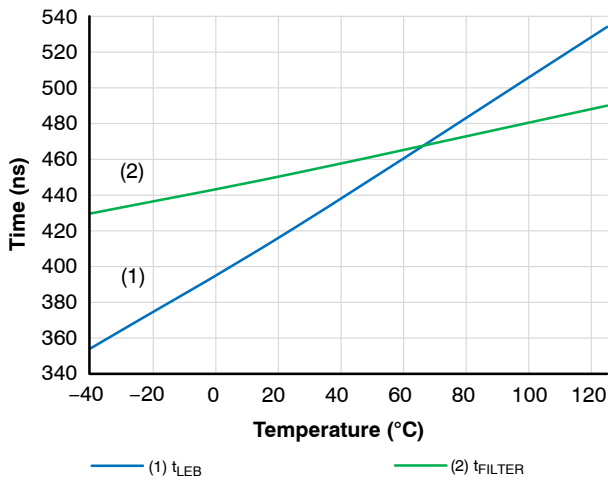

(Note: $V_{DD} = 5\text{ V}$, $V_{BS} = 15\text{ V}$)

Figure 33. DESAT Threshold Filtering Time, DESAT Leading Edge Blanking Time

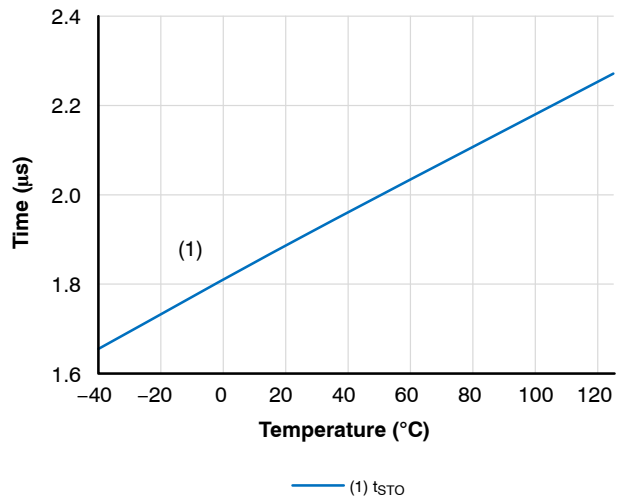

(Note: $V_{DD} = 5\text{ V}$, $V_{BS} = 15\text{ V}$)

Figure 34. Soft Turn Off Time

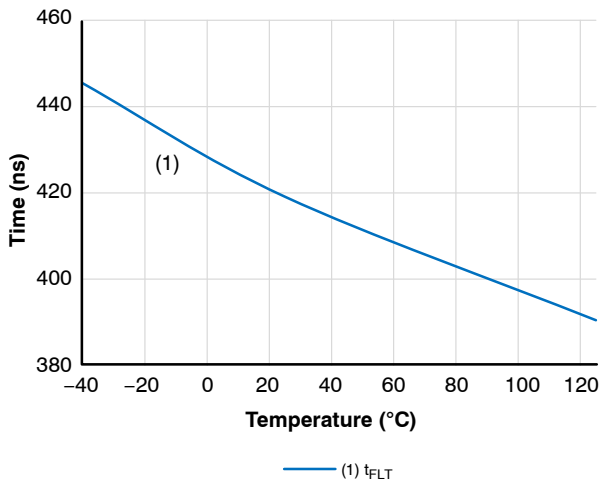

(Note: $V_{DD} = 5\text{ V}$, $V_{BS} = 15\text{ V}$)

Figure 35. FLT Delay Time

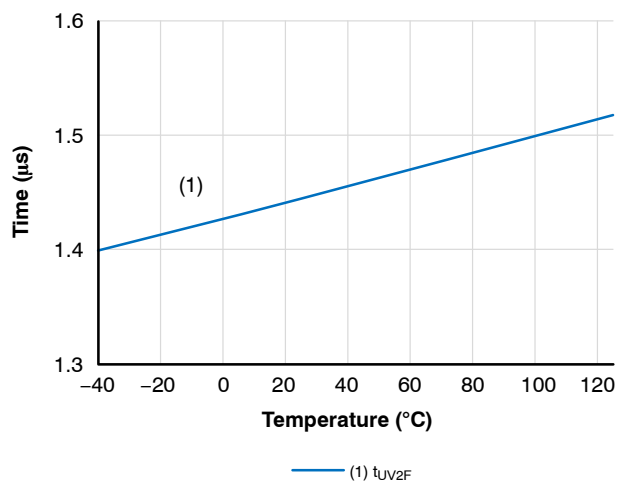

(Note: $V_{DD} = 5\text{ V}$, V_{BS} falls from HI to LOW)

Figure 36. UVLO2 Fall Delay

Under Voltage Lockout (UVLO)

UVLO ensures correct switching of IGBT connected to the driver output.

- The IGBT is turned-off and the output is disabled, if the supply V_{DD} drops below $V_{UVLO1-OUT-OFF}$ or V_{BS} drops below $V_{UVLO2-OUT-OFF}$.
- The driver output does not follow the input signal on V_{IN} until the V_{DD} / V_{BS} rises above the $V_{UVLOX-OUT-ON}$ and the input signal rising edge is applied to the V_{IN} .

With high loading gate capacitances over 10 nF it is important to follow the decoupling capacitor routing guidelines as shown on Figure 37. The decoupling capacitor value should be at least 10 μ F. Also gate resistor of minimal value of 2 Ω has to be used in order to avoid interference of the high di/dt with internal circuitry (e.g. UVLO2).

After the power-on of the driver there has to be a rising edge applied to the IN in order for the output to start following the inputs. This serves as a protection against producing partial pulses at the output if the V_{DD} or V_B is applied in the middle of the input PWM pulse.

Power Supply (V_{DD} , V_{BS})

NCx57084 is designed to support unipolar power supply.

For reliable high output current the suitable external power capacitors required. Parallel combination of 100 nF + 4,7 μ F ceramic capacitors is optimal for a wide range of applications using IGBT. For reliable driving IGBT modules (containing several parallel IGBT's) a higher capacity required (typically 100 nF + 10 μ F). Capacitors should be as close as possible to the driver's power pins.

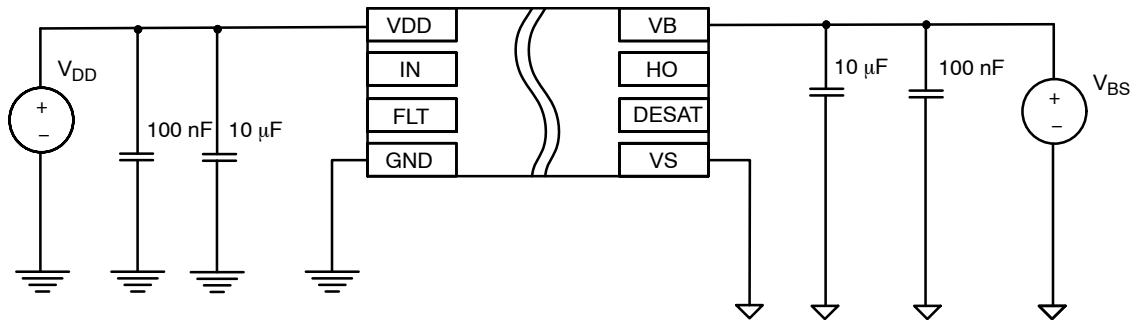

Figure 37. Power Supply

Desaturation Protection (DESAT)

Desaturation protection ensures the protection of IGBT at short circuit. When the V_{CESAT} voltage goes up and reaches the set limit, the output is driven low and \overline{FLT} output is activated. Blanking time can be set by internal current source and an external capacitor. To avoid false DESAT triggering and minimize blanking time, fast switching diodes with low internal capacitance are recommended. All DESAT protective diodes internal capacitances builds voltage divider with the blanking capacitor.

Warning: Both external protective diodes are recommended for the protection against voltage spikes caused by IGBT transients passing through parasitic capacitances.

$$t_{BLANK} = C_{BLANK} \cdot \frac{V_{DESAT-THR}}{I_{DESAT-CHG}}$$

$$V_{DESAT-THR} > R_{S-DESAT} \cdot I_{DESAT-CHG} + V_{FHV diode} + V_{CESAT_IGBT}$$

NCD57084, NCV57084

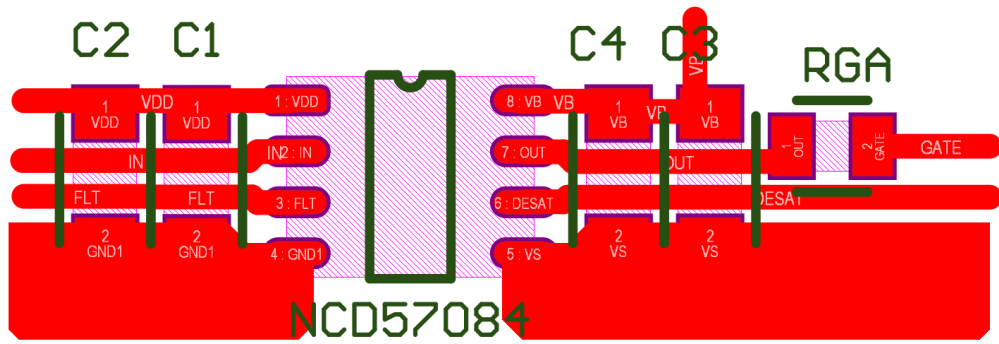

Figure 40. Recommended Layout

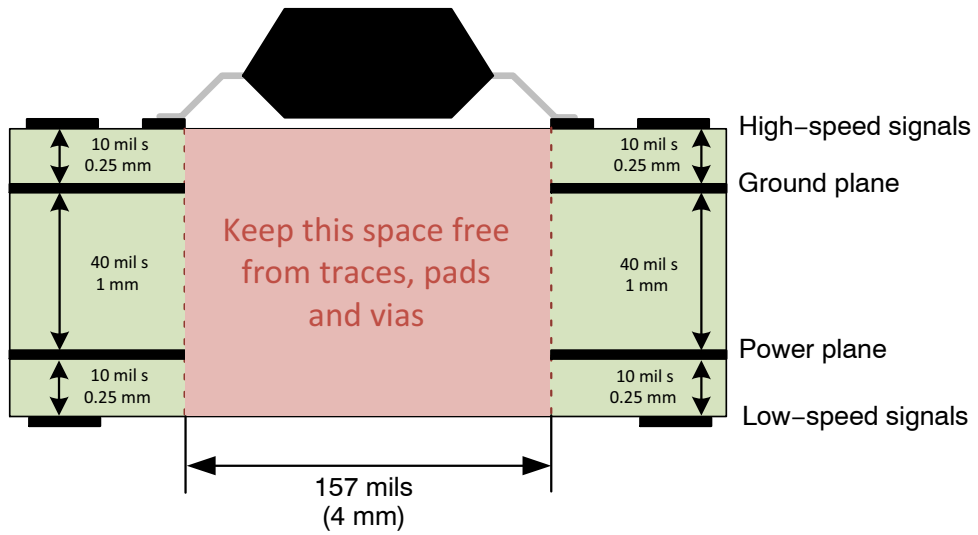
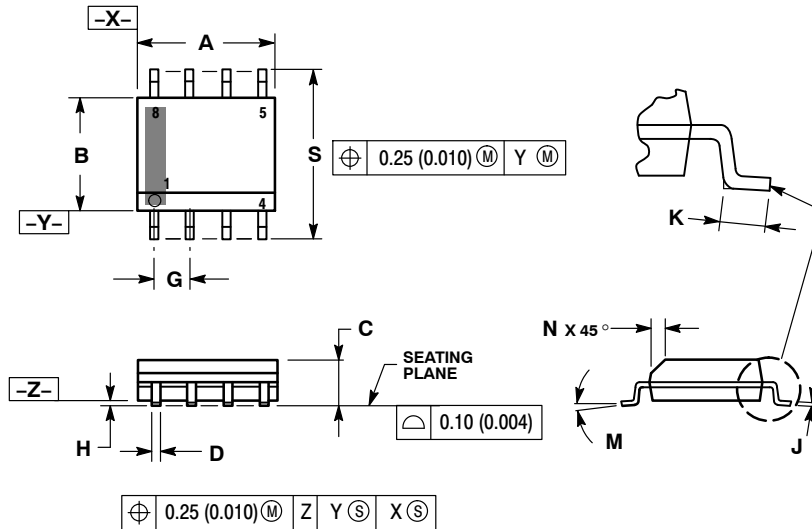

Figure 41. Recommended Layer Stack

NCD57084, NCV57084

PACKAGE DIMENSIONS

SOIC-8 NB
CASE 751-07
ISSUE AK



NOTES:

1. DIMENSIONING AND TOLERANCING PER ANSI Y14.5M, 1982.
2. CONTROLLING DIMENSION: MILLIMETER.
3. DIMENSION A AND B DO NOT INCLUDE MOLD PROTRUSION.
4. MAXIMUM MOLD PROTRUSION 0.15 (0.006) PER SIDE.
5. DIMENSION D DOES NOT INCLUDE DAMBAR PROTRUSION. ALLOWABLE DAMBAR PROTRUSION SHALL BE 0.127 (0.005) TOTAL IN EXCESS OF THE D DIMENSION AT MAXIMUM MATERIAL CONDITION.
6. 751-01 THRU 751-06 ARE OBSOLETE. NEW STANDARD IS 751-07.

DIM	MILLIMETERS		INCHES	
	MIN	MAX	MIN	MAX
A	4.80	5.00	0.189	0.197
B	3.80	4.00	0.150	0.157
C	1.35	1.75	0.053	0.069
D	0.33	0.51	0.013	0.020
G	1.27 BSC		0.050 BSC	
H	0.10	0.25	0.004	0.010
J	0.19	0.25	0.007	0.010
K	0.40	1.27	0.016	0.050
M	0° - 8°		0° - 8°	
N	0.25	0.50	0.010	0.020
S	5.80	6.20	0.228	0.244

GENERIC MARKING DIAGRAM*

SOLDERING FOOTPRINT*

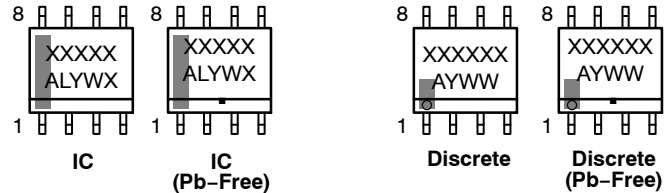
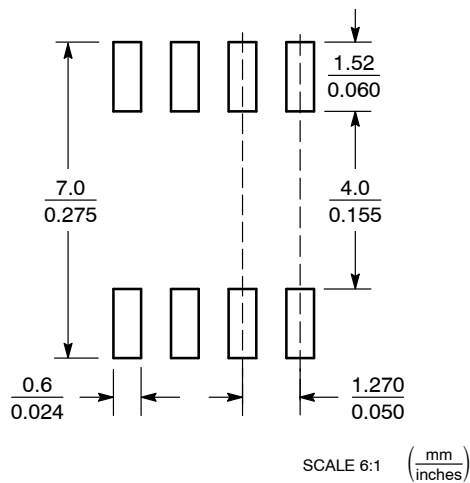

XXXXX = Specific Device Code
A = Assembly Location
L = Wafer Lot
Y = Year
W = Work Week
▪ = Pb-Free Package

XXXXXX = Specific Device Code
A = Assembly Location
Y = Year
WW = Work Week
▪ = Pb-Free Package

*This information is generic. Please refer to device data sheet for actual part marking. Pb-Free indicator, "G" or microdot "▪", may or may not be present. Some products may not follow the Generic Marking.

*For additional information on our Pb-Free strategy and soldering details, please download the ON Semiconductor Soldering and Mounting Techniques Reference Manual, SOLDERRM/D.

STYLES ON PAGE 2

NCD57084, NCV57084

SOIC-8 NB
CASE 751-07
ISSUE AK

DATE 16 FEB 2011

STYLE 1:

PIN 1. EMITTER
2. COLLECTOR
3. COLLECTOR
4. EMITTER
5. EMITTER
6. BASE
7. BASE
8. EMITTER

STYLE 5:

PIN 1. DRAIN
2. DRAIN
3. DRAIN
4. DRAIN
5. GATE
6. GATE
7. SOURCE
8. SOURCE

STYLE 9:

PIN 1. EMITTER, COMMON
2. COLLECTOR, DIE #1
3. COLLECTOR, DIE #2
4. EMITTER, COMMON
5. EMITTER, COMMON
6. BASE, DIE #2
7. BASE, DIE #1
8. EMITTER, COMMON

STYLE 13:

PIN 1. N.C.
2. SOURCE
3. SOURCE
4. GATE
5. DRAIN
6. DRAIN
7. DRAIN
8. DRAIN

STYLE 17:

PIN 1. VCC
2. V2OUT
3. V1OUT
4. TXE
5. RXE
6. VEE
7. GND
8. ACC

STYLE 21:

PIN 1. CATHODE 1
2. CATHODE 2
3. CATHODE 3
4. CATHODE 4
5. CATHODE 5
6. COMMON ANODE
7. COMMON ANODE
8. CATHODE 6

STYLE 25:

PIN 1. VIN
2. N/C
3. REXT
4. GND
5. IOUT
6. IOUT
7. IOUT
8. IOUT

STYLE 29:

PIN 1. BASE, DIE #1
2. EMITTER, #1
3. BASE, #2
4. EMITTER, #2
5. COLLECTOR, #2
6. COLLECTOR, #2
7. COLLECTOR, #1
8. COLLECTOR, #1

STYLE 2:

PIN 1. COLLECTOR, DIE, #1
2. COLLECTOR, #1
3. COLLECTOR, #2
4. COLLECTOR, #2
5. BASE, #2
6. EMITTER, #2
7. BASE, #1
8. EMITTER, #1

STYLE 6:

PIN 1. SOURCE
2. DRAIN
3. DRAIN
4. SOURCE
5. SOURCE
6. GATE
7. GATE
8. SOURCE

STYLE 10:

PIN 1. GROUND
2. BIAS 1
3. OUTPUT
4. GROUND
5. GROUND
6. BIAS 2
7. INPUT
8. GROUND

STYLE 14:

PIN 1. N-SOURCE
2. N-GATE
3. P-SOURCE
4. P-GATE
5. P-DRAIN
6. P-DRAIN
7. N-DRAIN
8. N-DRAIN

STYLE 18:

PIN 1. ANODE
2. ANODE
3. SOURCE
4. GATE
5. DRAIN
6. DRAIN
7. CATHODE
8. CATHODE

STYLE 22:

PIN 1. I/O LINE 1
2. COMMON CATHODE/VCC
3. COMMON CATHODE/VCC
4. I/O LINE 3
5. COMMON ANODE/GND
6. I/O LINE 4
7. I/O LINE 5
8. COMMON ANODE/GND

STYLE 26:

PIN 1. GND
2. dv/dt
3. ENABLE
4. ILIMIT
5. SOURCE
6. SOURCE
7. SOURCE
8. VCC

STYLE 30:

PIN 1. DRAIN 1
2. DRAIN 1
3. GATE 2
4. SOURCE 2
5. SOURCE 1/DRAIN 2
6. SOURCE 1/DRAIN 2
7. SOURCE 1/DRAIN 2
8. GATE 1

STYLE 3:

PIN 1. DRAIN, DIE #1
2. DRAIN, #1
3. DRAIN, #2
4. DRAIN, #2
5. GATE, #2
6. SOURCE, #2
7. GATE, #1
8. SOURCE, #1

STYLE 7:

PIN 1. INPUT
2. EXTERNAL BYPASS
3. THIRD STAGE SOURCE
4. GROUND
5. DRAIN
6. GATE 3
7. SECOND STAGE Vd
8. FIRST STAGE Vd

STYLE 11:

PIN 1. SOURCE 1
2. GATE 1
3. SOURCE 2
4. GATE 2
5. DRAIN 2
6. DRAIN 2
7. DRAIN 1
8. DRAIN 1

STYLE 15:

PIN 1. ANODE 1
2. ANODE 1
3. ANODE 1
4. ANODE 1
5. CATHODE, COMMON
6. CATHODE, COMMON
7. CATHODE, COMMON
8. CATHODE, COMMON

STYLE 19:

PIN 1. SOURCE 1
2. GATE 1
3. SOURCE 2
4. GATE 2
5. DRAIN 2
6. MIRROR 2
7. DRAIN 1
8. MIRROR 1

STYLE 23:

PIN 1. LINE 1 IN
2. COMMON ANODE/GND
3. COMMON ANODE/GND
4. LINE 2 IN
5. LINE 2 OUT
6. COMMON ANODE/GND
7. COMMON ANODE/GND
8. LINE 1 OUT

STYLE 27:

PIN 1. ILIMIT
2. OVLO
3. UVLO
4. INPUT+
5. SOURCE
6. SOURCE
7. SOURCE
8. DRAIN

STYLE 4:

PIN 1. ANODE
2. ANODE
3. ANODE
4. ANODE
5. ANODE
6. ANODE
7. ANODE
8. COMMON CATHODE

STYLE 8:

PIN 1. COLLECTOR, DIE #1
2. BASE, #1
3. BASE, #2
4. COLLECTOR, #2
5. COLLECTOR, #2
6. EMITTER, #2
7. EMITTER, #1
8. COLLECTOR, #1

STYLE 12:

PIN 1. SOURCE
2. SOURCE
3. SOURCE
4. GATE
5. DRAIN
6. DRAIN
7. DRAIN
8. DRAIN

STYLE 16:

PIN 1. EMITTER, DIE #1
2. BASE, DIE #1
3. EMITTER, DIE #2
4. BASE, DIE #2
5. COLLECTOR, DIE #2
6. COLLECTOR, DIE #2
7. COLLECTOR, DIE #1
8. COLLECTOR, DIE #1

STYLE 20:

PIN 1. SOURCE (N)
2. GATE (N)
3. SOURCE (P)
4. GATE (P)
5. DRAIN
6. DRAIN
7. DRAIN
8. DRAIN

STYLE 24:

PIN 1. BASE
2. EMITTER
3. COLLECTOR/ANODE
4. COLLECTOR/ANODE
5. CATHODE
6. CATHODE
7. COLLECTOR/ANODE
8. COLLECTOR/ANODE

STYLE 28:

PIN 1. SW_TO_GND
2. DASIC_OFF
3. DASIC_SW_DET
4. GND
5. V_MON
6. VBULK
7. VBULK
8. VIN

ON Semiconductor and  are trademarks of Semiconductor Components Industries, LLC dba ON Semiconductor or its subsidiaries in the United States and/or other countries. ON Semiconductor owns the rights to a number of patents, trademarks, copyrights, trade secrets, and other intellectual property. A listing of ON Semiconductor's product/patent coverage may be accessed at www.onsemi.com/site/pdf/Patent-Marking.pdf. ON Semiconductor reserves the right to make changes without further notice to any products herein. ON Semiconductor makes no warranty, representation or guarantee regarding the suitability of its products for any particular purpose, nor does ON Semiconductor assume any liability arising out of the application or use of any product or circuit, and specifically disclaims any and all liability, including without limitation special, consequential or incidental damages. Buyer is responsible for its products and applications using ON Semiconductor products, including compliance with all laws, regulations and safety requirements or standards, regardless of any support or applications information provided by ON Semiconductor. "Typical" parameters which may be provided in ON Semiconductor data sheets and/or specifications can and do vary in different applications and actual performance may vary over time. All operating parameters, including "Typicals" must be validated for each customer application by customer's technical experts. ON Semiconductor does not convey any license under its patent rights nor the rights of others. ON Semiconductor products are not designed, intended, or authorized for use as a critical component in life support systems or any FDA Class 3 medical devices or medical devices with a same or similar classification in a foreign jurisdiction or any devices intended for implantation in the human body. Should Buyer purchase or use ON Semiconductor products for any such unintended or unauthorized application, Buyer shall indemnify and hold ON Semiconductor and its officers, employees, subsidiaries, affiliates, and distributors harmless against all claims, costs, damages, and expenses, and reasonable attorney fees arising out of, directly or indirectly, any claim of personal injury or death associated with such unintended or unauthorized use, even if such claim alleges that ON Semiconductor was negligent regarding the design or manufacture of the part. ON Semiconductor is an Equal Opportunity/Affirmative Action Employer. This literature is subject to all applicable copyright laws and is not for resale in any manner.

PUBLICATION ORDERING INFORMATION

LITERATURE FULFILLMENT:

Email Requests to: orderlit@onsemi.com

ON Semiconductor Website: www.onsemi.com

TECHNICAL SUPPORT

North American Technical Support:
Voice Mail: 1 800-282-9855 Toll Free USA/Canada
Phone: 011 421 33 790 2910

Europe, Middle East and Africa Technical Support:

Phone: 00421 33 790 2910

For additional information, please contact your local Sales Representative