

206151-1 ✓ ACTIVE

AMP | AMP CPC

TE Internal #: 206151-1

Circular Power Connectors, Housing, 600 VDC, Wire-to-Wire, 37 Position, Wire & Cable, Receptacle, Pin, Power & Signal, Black, All Plastic, AMP CPC

[View on TE.com >](#)



Connectors > Power Connectors > Circular Power > Circular Power Connectors > Cable/Panel Mount Connector, CPC Series 1



Connector Product Type: **Housing**

Operating Voltage: **600 VDC**

Connector System: **Wire-to-Wire**

Number of Positions: **37**

Sealable: **No**

[All Cable/Panel Mount Connector, CPC Series 1 \(57\)](#)

## Features

### Product Type Features

Connector Product Type	Housing
Connector System	Wire-to-Wire
Sealable	No
Connector & Contact Terminates To	Wire & Cable
Connector & Housing Type	Receptacle
Circular Connector Shell Type	All Plastic

### Configuration Features

Reverse Numbering	Without
Number of Positions	37
Number of Power Positions	0
Number of Signal Positions	37

### Electrical Characteristics



Operating Voltage	600 VAC
-------------------	---------

### Contact Features

Reverse Gender	No
Contact Type	Pin
Contact Protection	With

### Mechanical Attachment

Mating Alignment Type	Keyed
Mating Alignment	With
Panel Mount Feature Type	Flange with Mounting Holes
Mating Retention Type	Threaded Coupling
Screw & Hole Thread Size	1-3/8 - 18 UNEF-2A
Polarization Code	A
Connector Mounting Type	Panel Mount
Mating Retention	With
Panel Mount Feature	With

### Housing Features

Body Orientation	Straight
Housing Color	Black
Housing Material	Thermoplastic
Circular Connector Shell Size	23

### Usage Conditions

Operating Temperature Range	-55 – 105 °C[-67 – 221 °F]
Fluid Resistance	None

### Operation/Application

Circuit Application	Power & Signal
Shielded	No

### Industry Standards

UL Flammability Rating	UL 94V-0
------------------------	----------

### Packaging Features

Packaging Quantity	1
Packaging Method	Standard

## Product Compliance

For compliance documentation, visit the product page on [TE.com](https://www.te.com)>

EU RoHS Directive 2011/65/EU	Compliant
EU ELV Directive 2000/53/EC	Compliant
China RoHS 2 Directive MIIT Order No 32, 2016	No Restricted Materials Above Threshold
EU REACH Regulation (EC) No. 1907/2006	Current ECHA Candidate List: JUNE 2022 (224) Candidate List Declared Against: JUNE 2022 (224) Does not contain REACH SVHC
Halogen Content	BFR/CFR/PVC Free, but Br/Cl >900 ppm in other sources.
Solder Process Capability	Not applicable for solder process capability

### Product Compliance Disclaimer

This information is provided based on reasonable inquiry of our suppliers and represents our current actual knowledge based on the information they provided. This information is subject to change. The part numbers that TE has identified as EU RoHS compliant have a maximum concentration of 0.1% by weight in homogenous materials for lead, hexavalent chromium, mercury, PBB, PBDE, DBP, BBP, DEHP, DIBP, and 0.01% for cadmium, or qualify for an exemption to these limits as defined in the Annexes of Directive 2011/65/EU (RoHS2). Finished electrical and electronic equipment products will be CE marked as required by Directive 2011/65/EU. Components may not be CE marked. Additionally, the part numbers that TE has identified as EU ELV compliant have a maximum concentration of 0.1% by weight in homogenous materials for lead, hexavalent chromium, and mercury, and 0.01% for cadmium, or qualify for an exemption to these limits as defined in the Annexes of Directive 2000/53/EC (ELV). Regarding the REACH Regulation, the information TE provides on SVHC in articles for this part number is based on the latest European Chemicals Agency (ECHA) 'Guidance on requirements for substances in articles' posted at this URL: <https://echa.europa.eu/guidance-documents/guidance-on-reach>

## Compatible Parts

 <p>TE Part # 206150-1 CPC PLUG ASSEMBLY SIZE 23-37</p>	 <p>TE Part # 207299-4 FLANGE PLUG</p>	 <p>TE Part # CAT-AM71-C83998B CPC Cable Clamps</p>	 <p>TE Part # 206150-3 CPC PLUG ASSEMBLY SIZE 23-37</p>
 <p>TE Part # 206150-2 CPC PLUG, SZ 23-37, SMALL PACK</p>	 <p>TE Part # 2387129-1 PLUG CONN CA, STD, SER 1, SZ 23-37, L 0.5M</p>	 <p>TE Part # 2387129-2 PLUG CONN CA, STD, SER 1, SZ 23-37, L 1M</p>	 <p>TE Part # 2387129-3 PLUG CONN CA, STD, SER 1, SZ 23-37, L 2M</p>

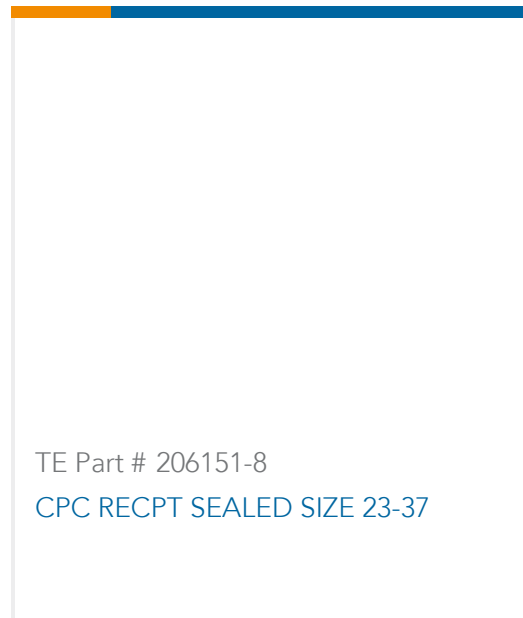

Also in the Series | AMP CPC

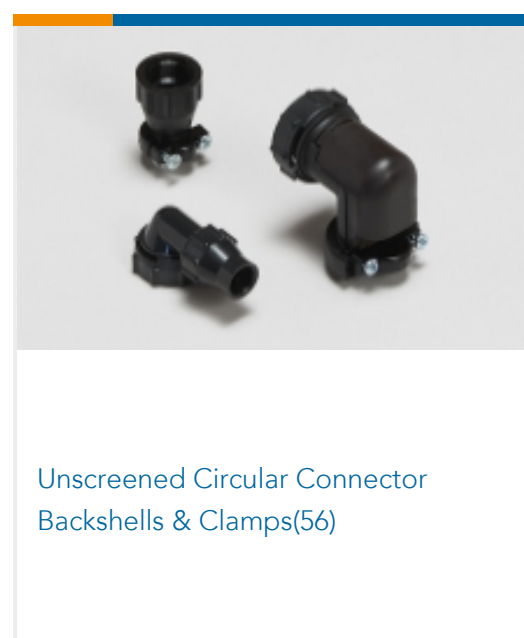
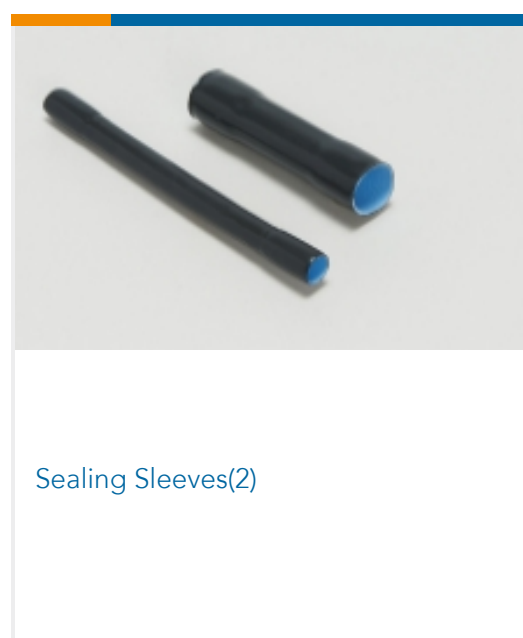
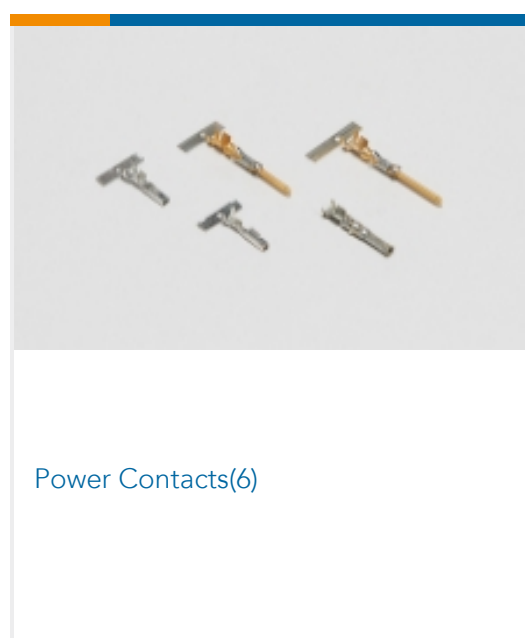
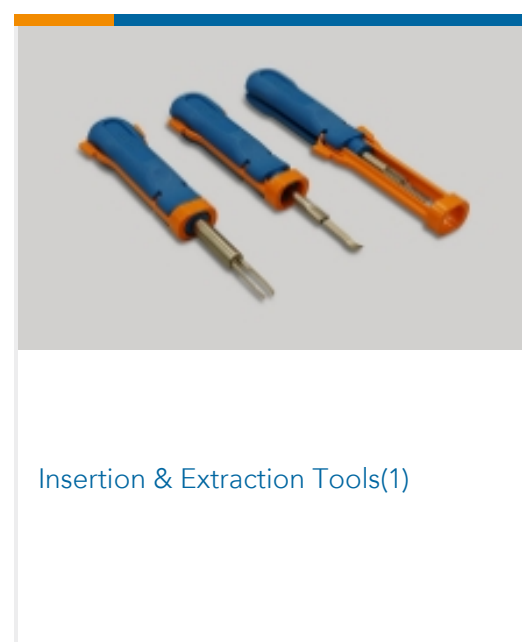
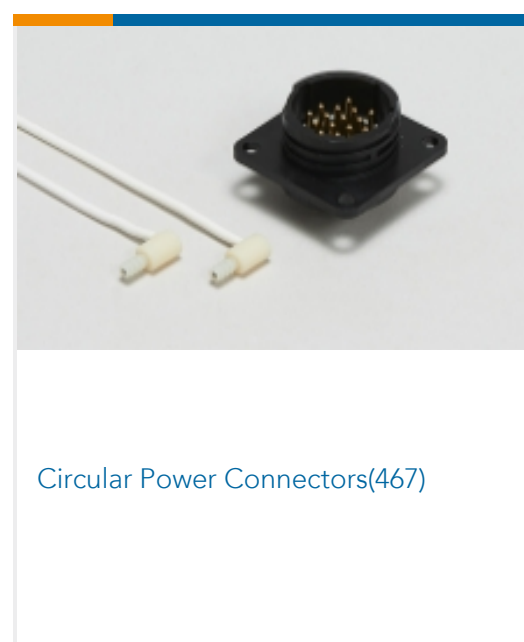
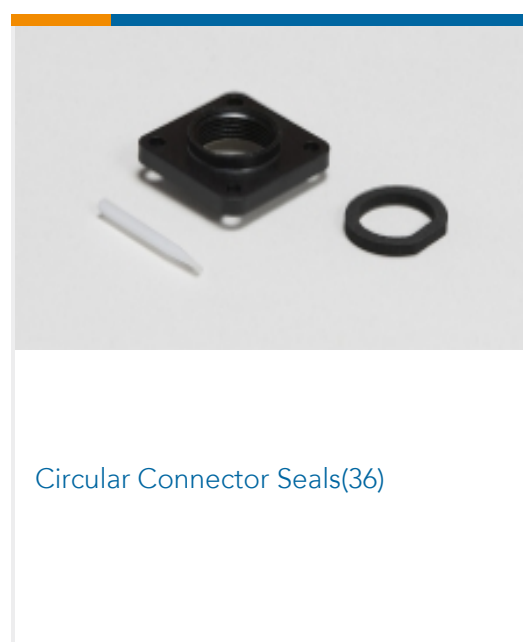
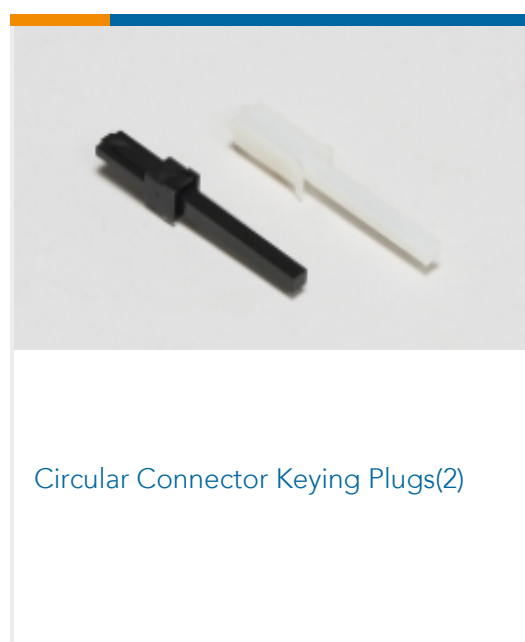
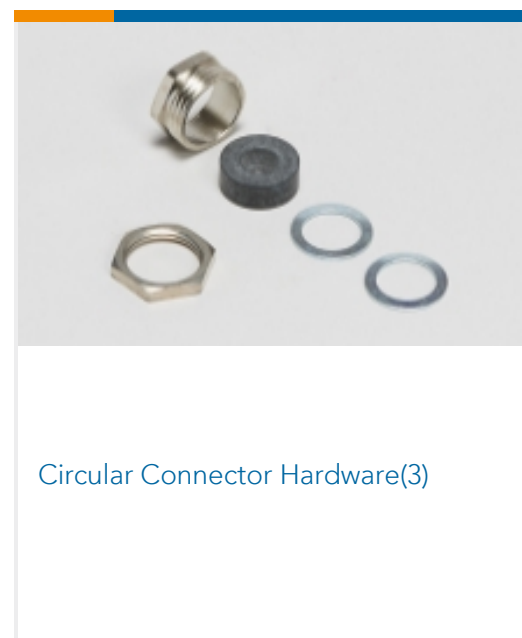
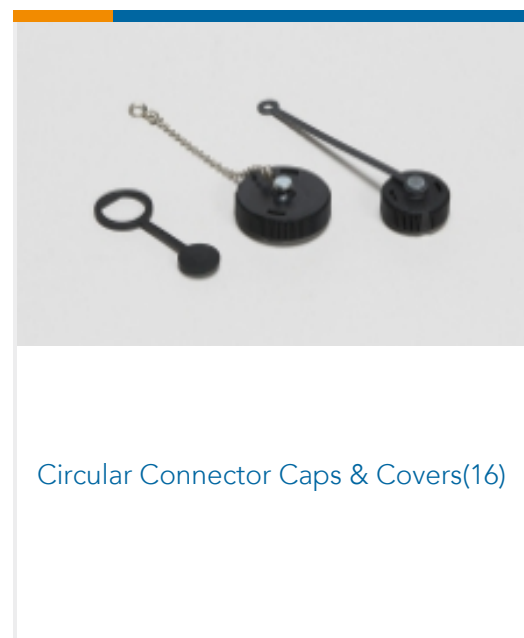
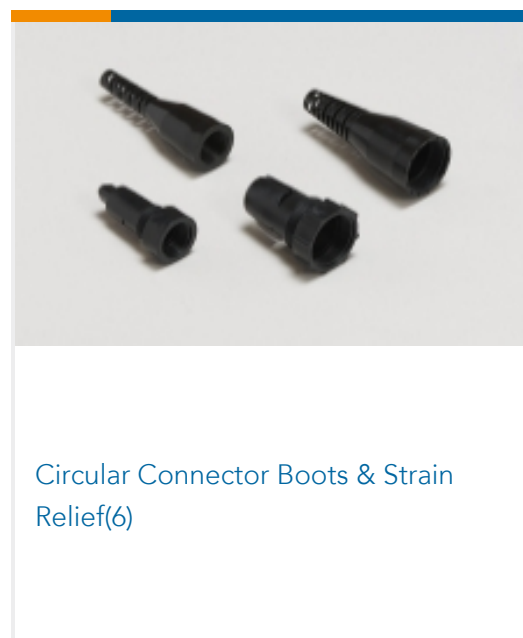
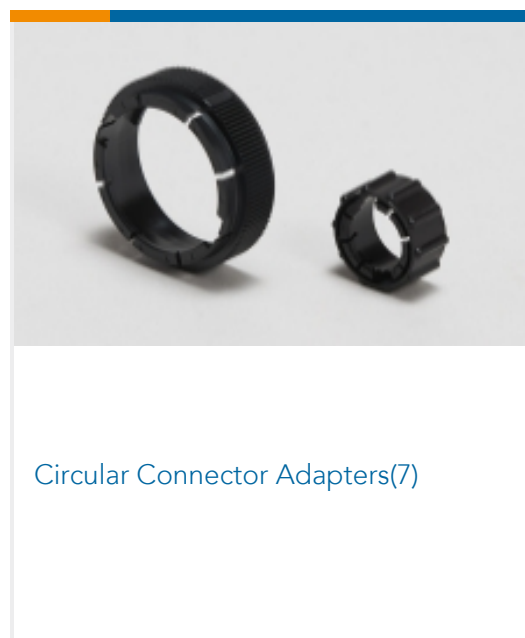

Customers Also Bought



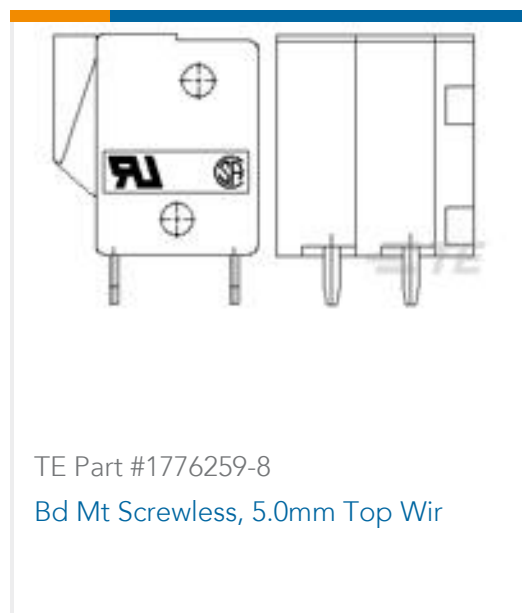

## Documents

### CAD Files

#### 3D PDF

3D

#### Customer View Model

[ENG\\_CVM\\_CVM\\_206151-1\\_AG.2d\\_dxf.zip](#)

English

#### Customer View Model

[ENG\\_CVM\\_CVM\\_206151-1\\_AG.3d\\_igs.zip](#)

English

#### Customer View Model

[ENG\\_CVM\\_CVM\\_206151-1\\_AG.3d\\_stp.zip](#)

English

By downloading the CAD file I accept and agree to the [Terms and Conditions](#) of use.

### Datasheets & Catalog Pages

[AMP Circular Connectors for Commercial Signal & Power Applications](#)

English

### Product Specifications

[Application Specification](#)

English

### Product Environmental Compliance

[MD\\_206151-1\\_07182018858\\_dmtec](#)

English

[MD\\_206151-1\\_07182018858\\_dmtec](#)

English



**Instruction Sheets**

[Instruction Sheet \(U.S.\)](#)

English

---

**Agency Approvals**

[UL Report](#)

English