

AspiraVision Compact for CDM

HID-AV C 35 /I CDM 220-240V 50/60Hz

AspiraVision is the mark of excellence in HID electronic gear technology – high-end, compact, lightweight and easy to use, with added features for optimal performance of 35, 50 and 70 W CDM lamps. The recently added switching function provides maximum flexibility for users by integrating three different wattage choices into a single driver.

Product data

• General Characteristics

Interface	-
Application code	-
Rated Lamptype	CDM
Rated Number of Lamps	1 piece
Rated Ballast-Lamp Power	35
Line Voltage	220-240 V
Line Current	0.25 A
Line Frequency	50/60 Hz
Housing	/I
Suitable for Outdoor use?	No
Lifetime 90% surv.@Tcaselife	40000 hr

• Operating Characteristics

Automatic restart	Yes
Ignition switch-off time	19 min
Ignition Voltage	3.0 (min), 5.0 (max) kV
Mains voltage safety (AC)	-18%/+10%
Mains voltage performance (AC)	-10%/+6%
Min. Mains voltage operational	198 (min) V
Output peak voltage	4000 (max) V
Inrush current Peak	6 (max) A
Inrush current Width	10 ms
Earth leakage current	0.25 (max) mA
Lamp Power Tolerance	-3%/+3%
PowerFactor 100% output power	0.95 -

Overvoltage protection 320Vac	48 hr
Overvoltage protection 350Vac	2 hr
Overvoltage protection 400Vac	5 min
Max ballast on MCB(16A type B)	58 x
Hum and Noise level	20 dB(A)

• Wiring Characteristics

Cable-Cap output-wires mutual	160 pF
Connector type	Insert
Max. cable length Device/Lamp	2 m
Striplength	10.0-11.0 mm
Wcs Ballast contacts	0.50-2.50 mm ²

• System Chars on driver level

Rated Lamp Power on CDM	39
System Power on CDM	43
Lamp Power on CDM	39
Power Loss on CDM	4

• Temperature Characteristics

Active temperature protection	Yes
F-marking	Yes
T-case life	70 C
T-case switch-off	85 (min) C

PHILIPS

AspiraVision Compact for CDM

T-ambient -20 (min), 55 (max) C
 T-storage -25 (min), 80 (max) C

VDE certificate Yes
 VDE-EMV certificate No
 CB Certificate Yes

• Product Dimensions

Length A1 188 mm
 Fixing Hole Distance 170 mm
 Length A2
 Width B1 82.7 mm
 Height C1 34.5 mm
 Fixing Hole Diameter 4.8 mm
 D1

• Product Data

Order code 913700647666
 Full product code 913700647666
 Full product name HID-AV C 35 /I CDM 220-240V 50/60Hz
 Order product name HID-AV C 35 /I CDM 220-240V 50/60Hz
 Pieces per pack 1
 Packing configuration 12
 Packs per outerbox 12
 Bar code on pack - EAN1 8711500881663
 Bar code on outerbox - EAN3 8727900885248
 Logistic code(s) - 12NC 913700647666
 Net weight per piece 0.342 kg

• Approval & Application Chars

EMI 9 kHz ... 300MHz CISPR 15 ed 7.2
 Vibrations IEC 68-2-6 Fc
 Bumps IEC 68-2-29 Eb
 Humidity EN 61347-2-3 and 2-1
 Approval marks ENEC / CE / VDE-EMC
 CE marking Yes
 ENEC certificate Yes

Dimensional drawing

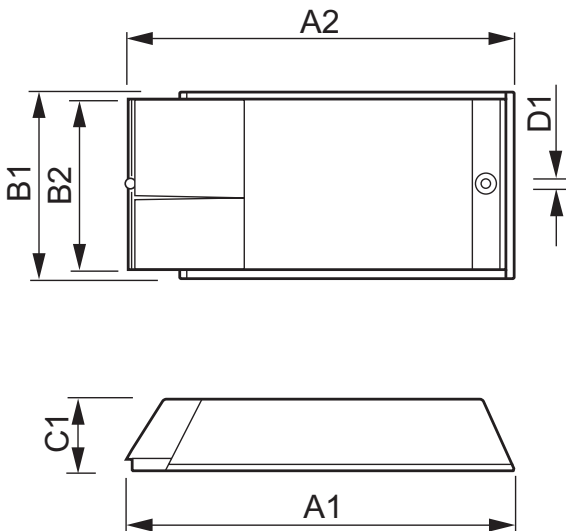

HID-AV C 35 /I CDM 220-240V 50/60Hz

Product	A1 (Norm)	A2 (Norm)	B1 (Norm)	B2 (Norm)	C1 (Norm)	D1 (Norm)
HID-AV C 35 /I CDM 220-240V 50/60Hz	188	170	82.7	-	34.5	4.8

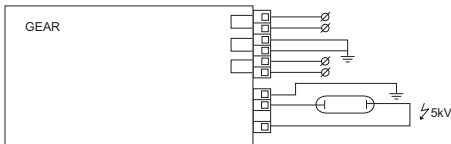

© 2014 Koninklijke Philips N.V. (Royal Philips)
 All rights reserved.

Specifications are subject to change without notice. Trademarks are the property of Koninklijke Philips N.V. (Royal Philips) or their respective owners.

www.philips.com/lighting

2014, April 11
 data subject to change