

MIRELLA-50-S-PF

~15° spot beam

TECHNICAL SPECIFICATIONS:

Dimensions	Ø 49.9 mm
Height	24 mm
Fastening	socket
Colour	metal
Box size	480 x 280 x 300 mm
Box weight	3 kg
Quantity in Box	336 pcs
ROHS compliant	yes ⓘ







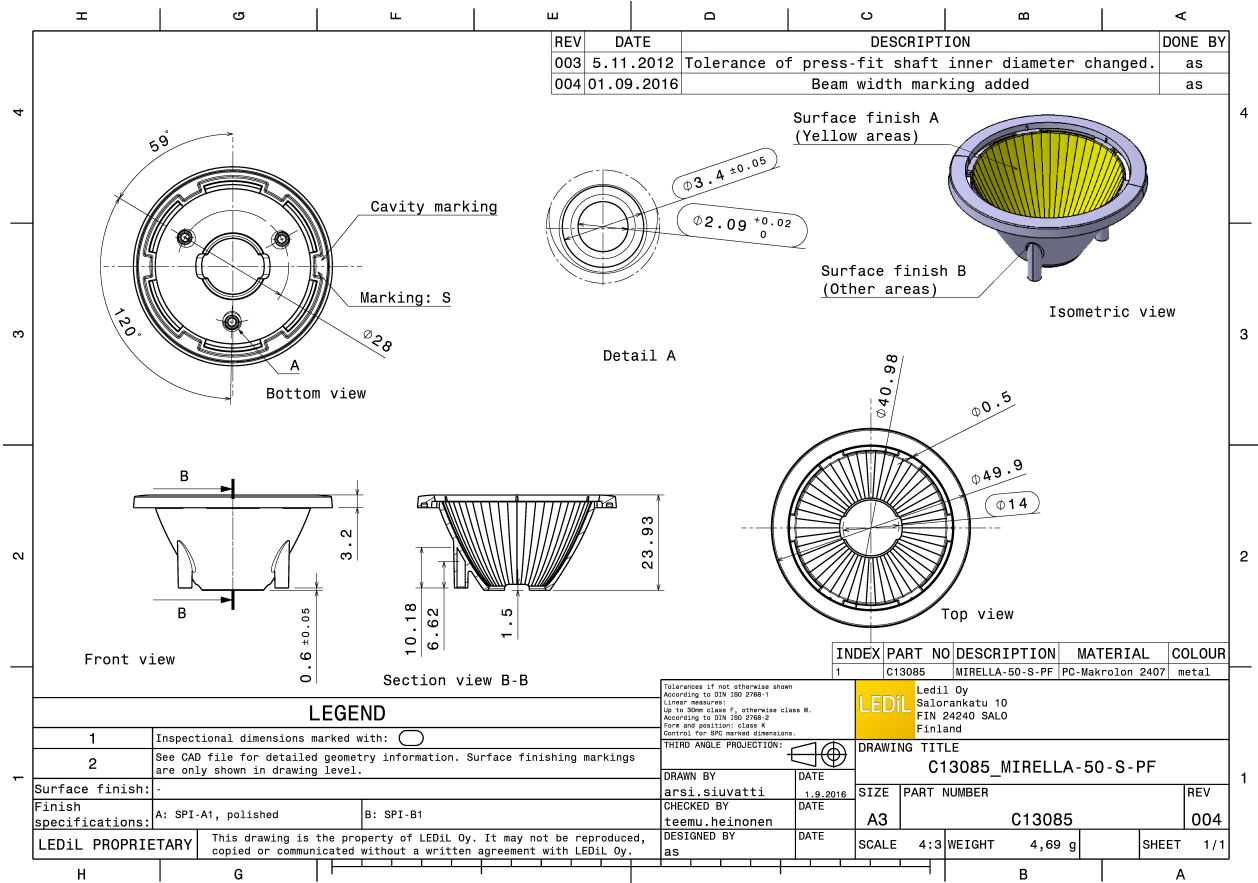

MATERIAL SPECIFICATIONS:

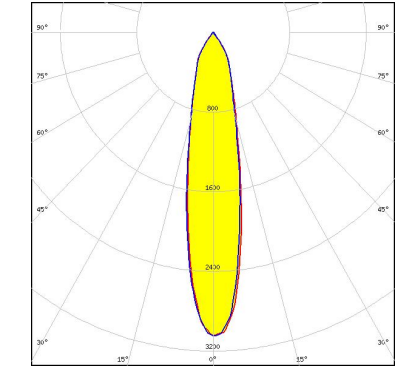

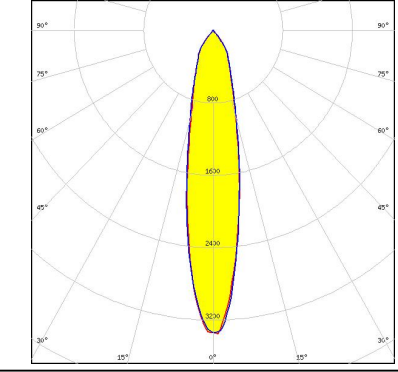
Component	Type	Material	Colour	Coating
MIRELLA-50-S-PF	Reflector	PC	metal	lacquer

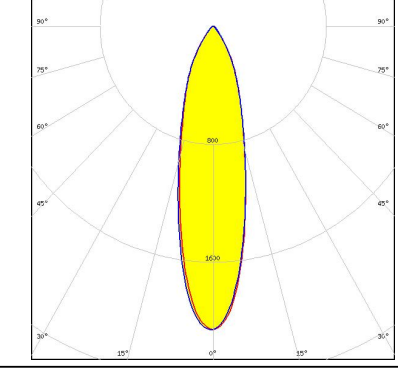

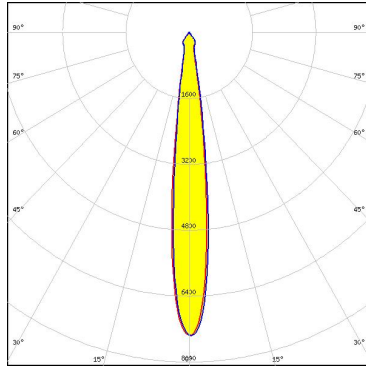
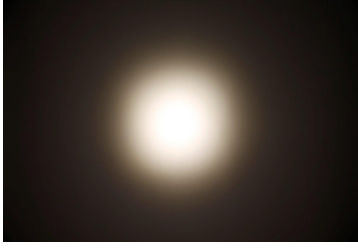
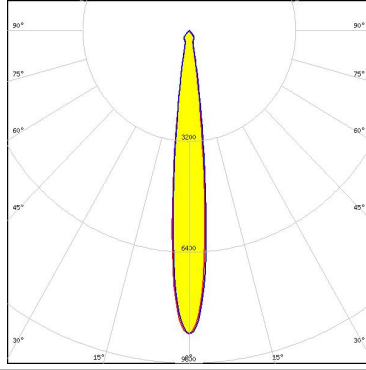
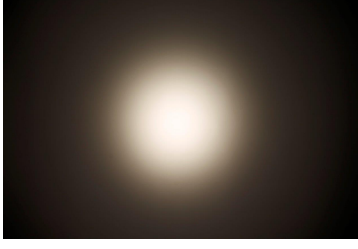
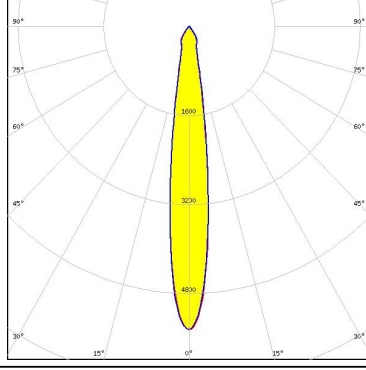
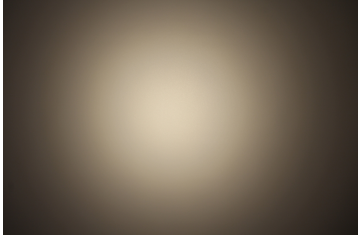

PHOTOMETRIC DATA (MEASURED):

<p>bridgelux.</p> <p>LED V10 Gen7 FWHM 21.0° Efficiency 81 % Peak intensity 3.100 cd/lm LEDs/each optic 1 Light colour White</p> <p>Required components: C13709_PF-SOCKET-VERO13-18 C13333_MIRELLA-CL</p>		
<p>bridgelux.</p> <p>LED V10 Gen7 FWHM 21.0° Efficiency 91 % Peak intensity 3.400 cd/lm LEDs/each optic 1 Light colour White</p> <p>Required components: C13709_PF-SOCKET-VERO13-18 Bender Wirth: 486 Typ L1</p>		
<p>bridgelux.</p> <p>LED V10 Gen7 FWHM 26.0° Efficiency 79 % Peak intensity 2.100 cd/lm LEDs/each optic 1 Light colour White</p> <p>Required components: C13709_PF-SOCKET-VERO13-18 C12479_MIRELLA-DL</p>		
<p>bridgelux.</p> <p>LED V6 Gen6 FWHM 18.0° Efficiency 73 % Peak intensity 4.270 cd/lm LEDs/each optic 1 Light colour White</p> <p>Required components: C13709_PF-SOCKET-VERO13-18 C12479_MIRELLA-DL Bender Wirth: 460 Typ L1</p>		

PHOTOMETRIC DATA (MEASURED):

<p>bridgelux.</p> <p>LED V6 Gen6 FWHM 13.0° Efficiency 84 % Peak intensity 7.400 cd/lm LEDs/each optic 1 Light colour White</p> <p>Required components: C13761_PF-SOCKET-CXA15 C13333_MIRELLA-CL</p>		
<p>bridgelux.</p> <p>LED V6 Gen6 FWHM 12.0° Efficiency 90 % Peak intensity 8.800 cd/lm LEDs/each optic 1 Light colour White</p> <p>Required components: C13761_PF-SOCKET-CXA15</p>		
<p>bridgelux.</p> <p>LED V6 Gen6 FWHM 15.0° Efficiency 84 % Peak intensity 5.500 cd/lm LEDs/each optic 1 Light colour White</p> <p>Required components: C13761_PF-SOCKET-CXA15 C12479_MIRELLA-DL</p>		
<p>bridgelux.</p> <p>LED V8 Gen6 FWHM 20.0° Efficiency 71 % Peak intensity 3.370 cd/lm LEDs/each optic 1 Light colour White</p> <p>Required components: C13709_PF-SOCKET-VERO13-18 C12479_MIRELLA-DL Bender Wirth: 460 Typ L1</p>		

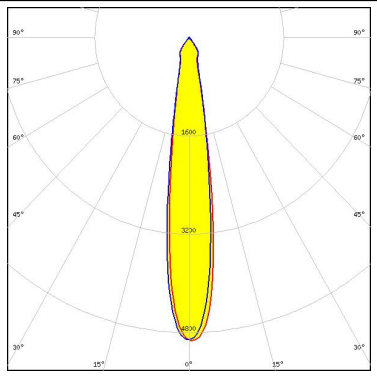

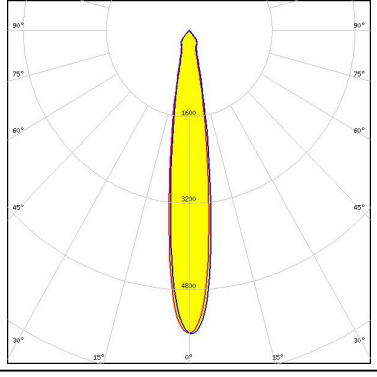
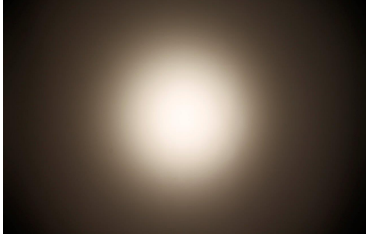
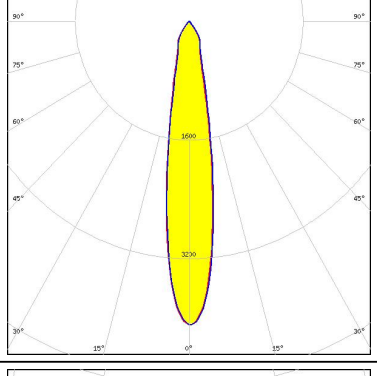
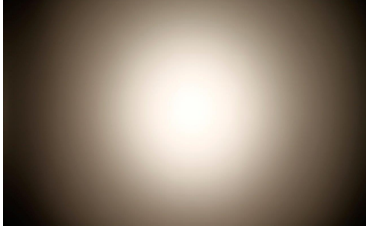
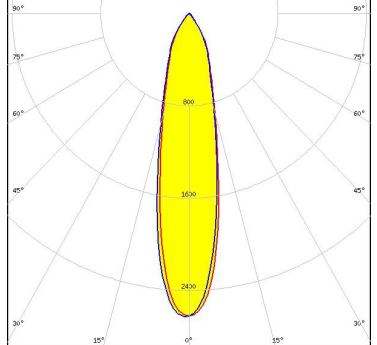
PHOTOMETRIC DATA (MEASURED):

<p>bridgelux.</p> <p>LED V8 Gen6 FWHM 16.0° Efficiency 84 % Peak intensity 4.900 cd/lm LEDs/each optic 1 Light colour White Required components: C13761_PF-SOCKET-CXA15 C13333_MIRELLA-CL</p>		
<p>bridgelux.</p> <p>LED V8 Gen6 FWHM 15.0° Efficiency 90 % Peak intensity 5.600 cd/lm LEDs/each optic 1 Light colour White Required components: C13761_PF-SOCKET-CXA15</p>		
<p>bridgelux.</p> <p>LED V8 Gen6 FWHM 18.0° Efficiency 85 % Peak intensity 4.100 cd/lm LEDs/each optic 1 Light colour White Required components: C13761_PF-SOCKET-CXA15 C12479_MIRELLA-DL</p>		
<p>bridgelux.</p> <p>LED VERO10 FWHM 23.0° Efficiency 83 % Peak intensity 2.600 cd/lm LEDs/each optic 1 Light colour White Required components: C13708_PF-SOCKET-VERO10 C12479_MIRELLA-DL</p>		

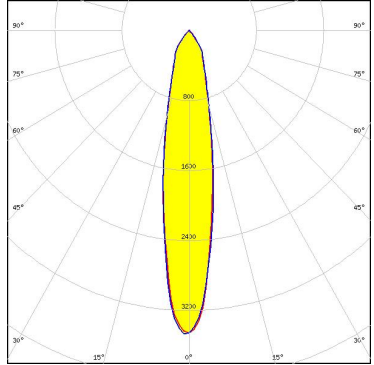
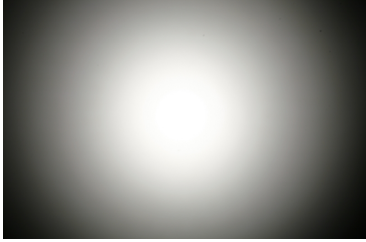
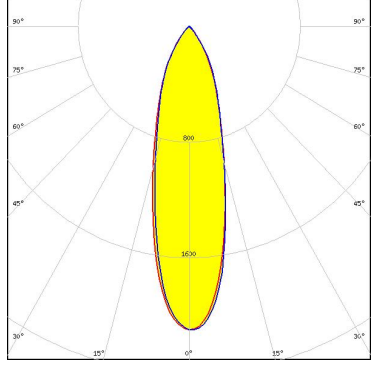
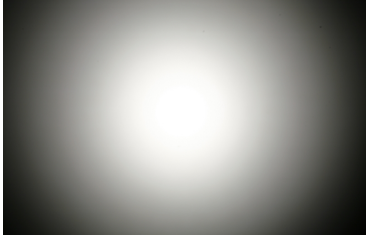
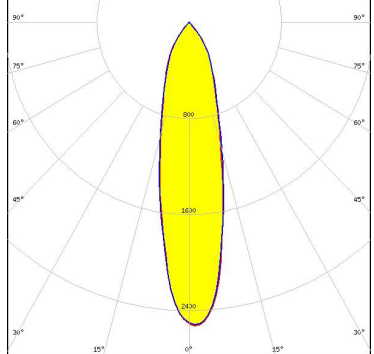
PHOTOMETRIC DATA (MEASURED):

<p>bridgelux.</p> <p>LED VERO10 FWHM 23.0° Efficiency 83 % Peak intensity 2.600 cd/m LEDs/each optic 1 Light colour White Required components: C13708_PF-SOCKET-VERO10 C13333_MIRELLA-CL</p>		
<p>bridgelux.</p> <p>LED VERO10 FWHM 20.0° Efficiency 88 % Peak intensity 3.500 cd/m LEDs/each optic 1 Light colour White Required components: C13708_PF-SOCKET-VERO10</p>		
<p>bridgelux.</p> <p>LED VERO13 FWHM 28.0° Efficiency 84 % Peak intensity 2.100 cd/m LEDs/each optic 1 Light colour White Required components: C13709_PF-SOCKET-VERO13-18 C12479_MIRELLA-DL</p>		
<p>bridgelux.</p> <p>LED VERO13 FWHM 25.0° Efficiency 89 % Peak intensity 2.540 cd/m LEDs/each optic 1 Light colour White Required components: C13709_PF-SOCKET-VERO13-18</p>		

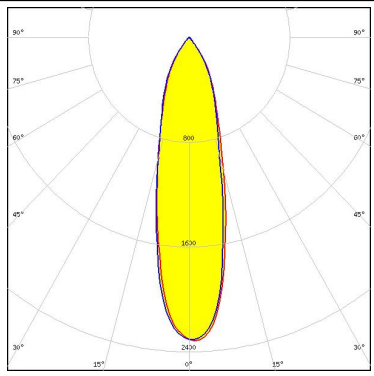
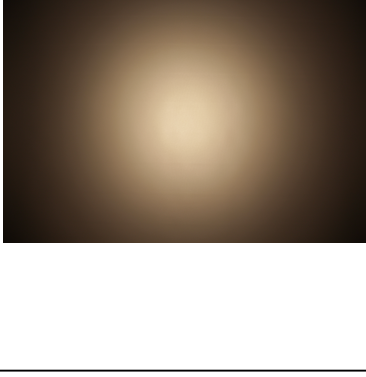
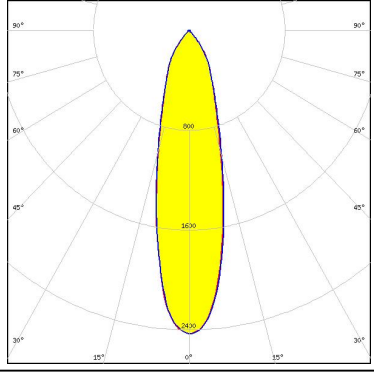
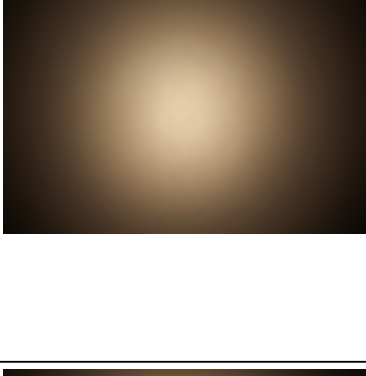
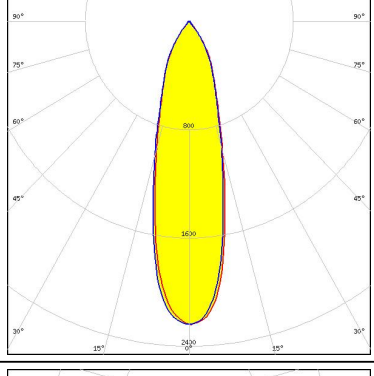
PHOTOMETRIC DATA (MEASURED):

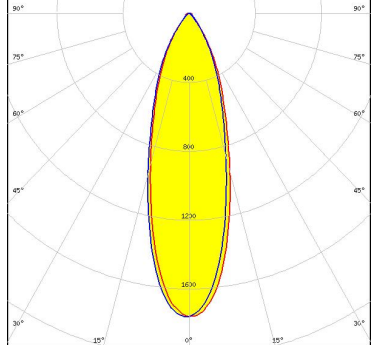
<p>bridgelux.</p> <p>LED VERO13 FWHM 26.0° Efficiency 83 % Peak intensity 2.320 cd/lm LEDs/each optic 1 Light colour White</p> <p>Required components: C13709_PF-SOCKET-VERO13-18 C13333_MIRELLA-CL</p>		
<p>bridgelux.</p> <p>LED Xenio Point 13mm FWHM 26.0° Efficiency 87 % Peak intensity 2.400 cd/lm LEDs/each optic 1 Light colour White</p> <p>Required components: C13709_PF-SOCKET-VERO13-18</p>		
<p>bridgelux.</p> <p>LED Xenio Point 13mm FWHM 27.0° Efficiency 83 % Peak intensity 2.240 cd/lm LEDs/each optic 1 Light colour White</p> <p>Required components: C13709_PF-SOCKET-VERO13-18 C13333_MIRELLA-CL</p>		
<p>bridgelux.</p> <p>LED Xenio Point 13mm FWHM 31.0° Efficiency 81 % Peak intensity 1.760 cd/lm LEDs/each optic 1 Light colour White</p> <p>Required components: C13709_PF-SOCKET-VERO13-18 C12479_MIRELLA-DL</p>		

PHOTOMETRIC DATA (MEASURED):

CITIZEN

LED CLL01x
FWHM 15.0°
Efficiency 84 %
Peak intensity 5.800 cd/lm
LEDs/each optic 1
Light colour White
Required components:
C13083_PF-SOCKET
C12479_MIRELLA-DL

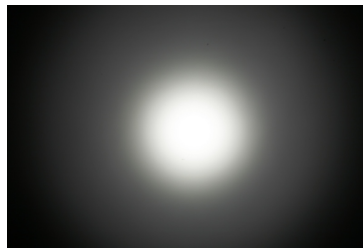

CITIZEN

LED CLL01x
FWHM 14.0°
Efficiency 88 %
Peak intensity 7.700 cd/lm
LEDs/each optic 1
Light colour White
Required components:
C13083_PF-SOCKET

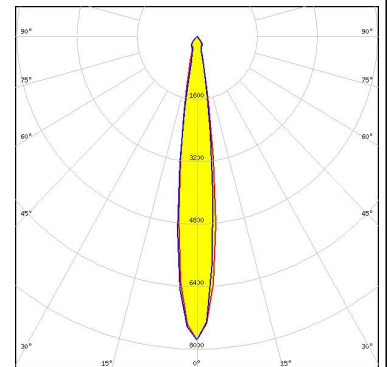

CITIZEN

LED CLL01x
FWHM 13.0°
Efficiency 84 %
Peak intensity 7.600 cd/lm
LEDs/each optic 1
Light colour White
Required components:
C13083_PF-SOCKET
C13333_MIRELLA-CL

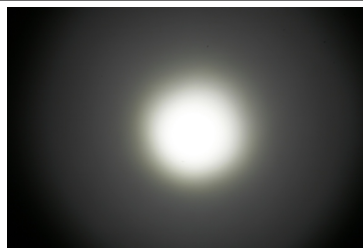

CITIZEN

LED CLL02x/CLU02x (LES10)
FWHM 19.0°
Efficiency 87 %
Peak intensity 4.200 cd/lm
LEDs/each optic 1
Light colour White
Required components:
C13083_PF-SOCKET

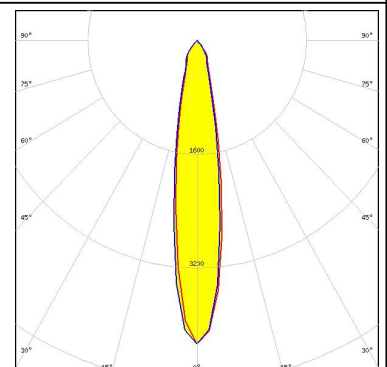

PHOTOMETRIC DATA (MEASURED):

CITIZEN

LED CLL02x/CLU02x (LES10)
FWHM 27.0°
Efficiency 77 %
Peak intensity 2.000 cd/lm
LEDs/each optic 1
Light colour White
Required components:
C13709_PF-SOCKET-VERO13-18
C12479_MIRELLA-DL
Bender Wirth: 434 Typ L1

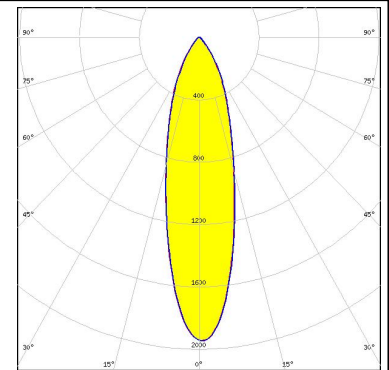
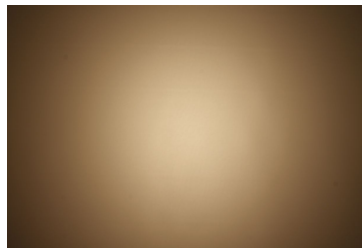

CITIZEN

LED CLL02x/CLU02x (LES10)
FWHM 18.0°
Efficiency 83 %
Peak intensity 5.100 cd/lm
LEDs/each optic 1
Light colour White
Required components:
C13083_PF-SOCKET
C13333_MIRELLA-CL

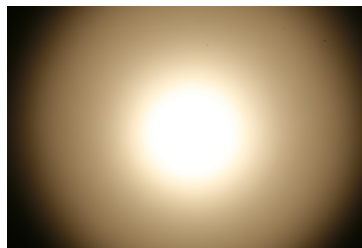

CITIZEN

LED CLL02x/CLU02x (LES10)
FWHM 21.0°
Efficiency 84 %
Peak intensity 3.100 cd/lm
LEDs/each optic 1
Light colour White
Required components:
C13709_PF-SOCKET-VERO13-18
Bender Wirth: 434 Typ L1

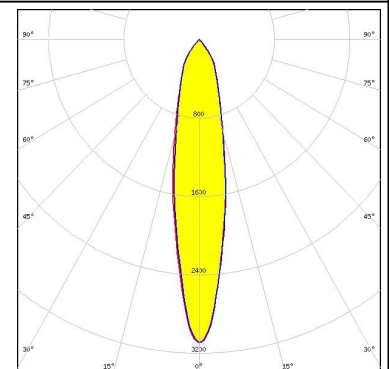
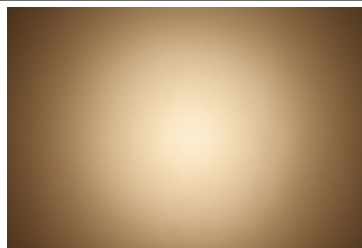

CITIZEN

LED CLL02x/CLU02x (LES10)
FWHM 20.0°
Efficiency 83 %
Peak intensity 4.200 cd/lm
LEDs/each optic 1
Light colour White
Required components:
C13083_PF-SOCKET
C12479_MIRELLA-DL

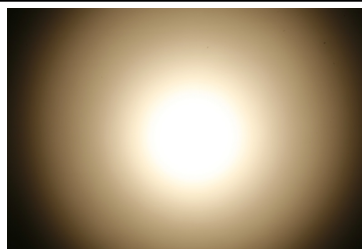

PHOTOMETRIC DATA (MEASURED):

CITIZEN

LED CLL02x/CLU02x (LES10)
 FWHM 25.0°
 Efficiency %
 Peak intensity 1.500 cd/lm
 LEDs/each optic 1
 Light colour White
 Required components:
 C13083_PF-SOCKET
 C13723_MIRELLA-RZL

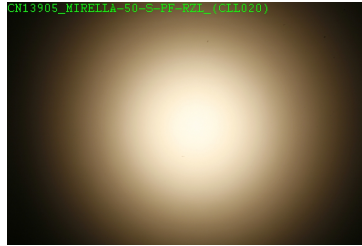

CITIZEN

LED CLL02x/CLU02x (LES10)
 FWHM 20.0°
 Efficiency 80 %
 Peak intensity 3.100 cd/lm
 LEDs/each optic 1
 Light colour White
 Required components:
 C13709_PF-SOCKET-VERO13-18
 C13333_MIRELLA-CL
 Bender Wirth: 434 Typ L1

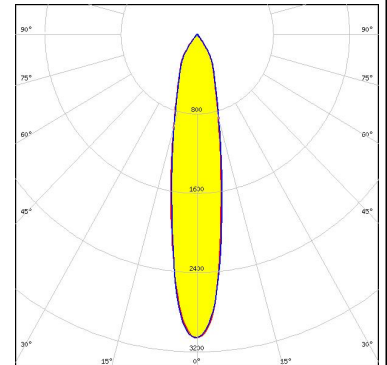

CITIZEN

LED CLU700/701
 FWHM 13.0°
 Efficiency 83 %
 Peak intensity 6.600 cd/lm
 LEDs/each optic 1
 Light colour White
 Required components:
 C13083_PF-SOCKET
 C13333_MIRELLA-CL

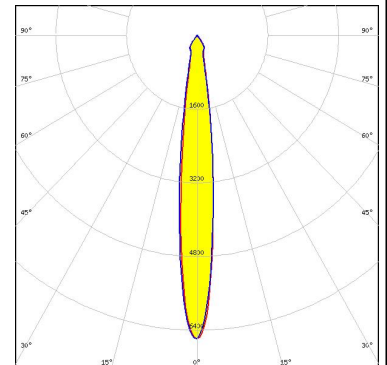
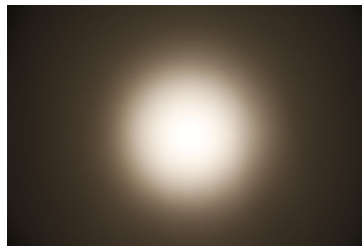

CITIZEN

LED CLU700/701
 FWHM 14.0°
 Efficiency 79 %
 Peak intensity 4.800 cd/lm
 LEDs/each optic 1
 Light colour White
 Required components:
 C13709_PF-SOCKET-VERO13-18
 C13333_MIRELLA-CL
 Bender Wirth: 434 Typ L1

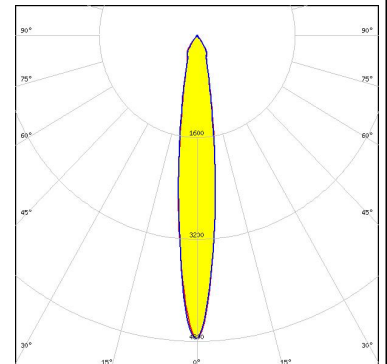

PHOTOMETRIC DATA (MEASURED):

CITIZEN

LED CLU700/701
 FWHM 20.0°
 Efficiency 79 %
 Peak intensity 3.100 cd/lm
 LEDs/each optic 1
 Light colour White
 Required components:
 C13709_PF-SOCKET-VERO13-18
 C12479_MIRELLA-DL
 Bender Wirth: 434 Typ L1

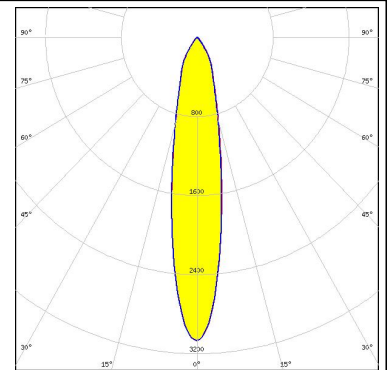
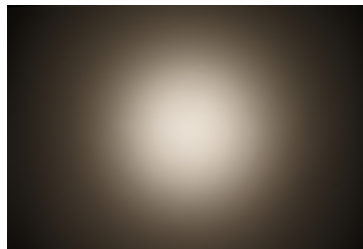

CITIZEN

LED CLU700/701
 FWHM 17.0°
 Efficiency 82 %
 Peak intensity 4.000 cd/lm
 LEDs/each optic 1
 Light colour White
 Required components:
 C13083_PF-SOCKET
 C12479_MIRELLA-DL

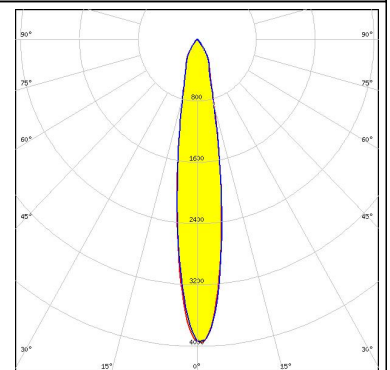
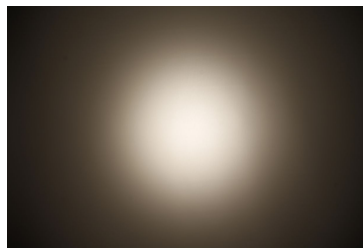

CITIZEN

LED CLU700/701
 FWHM 13.0°
 Efficiency 89 %
 Peak intensity 7.300 cd/lm
 LEDs/each optic 1
 Light colour White
 Required components:
 C13083_PF-SOCKET

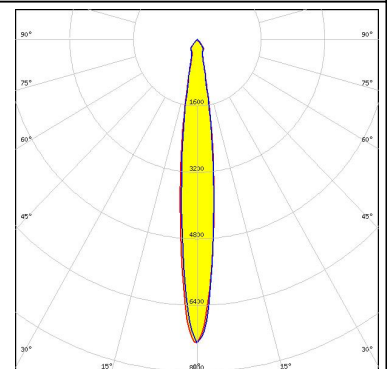
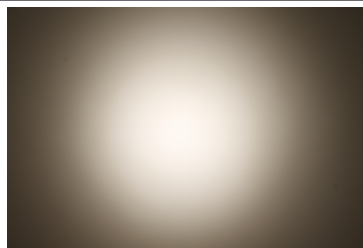

CITIZEN

LED CLU700/701
 FWHM 19.0°
 Efficiency 84 %
 Peak intensity 4.000 cd/lm
 LEDs/each optic 1
 Light colour White
 Required components:
 C13709_PF-SOCKET-VERO13-18
 Bender Wirth: 434 Typ L1

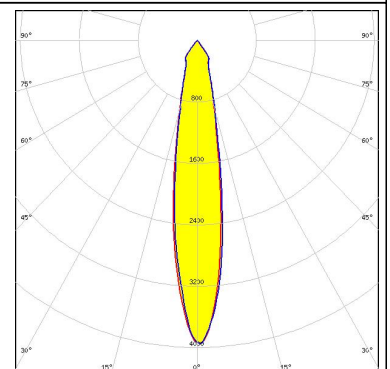

PHOTOMETRIC DATA (MEASURED):

CITIZEN

LED CLU700/701
 FWHM 23.0°
 Efficiency 82 %
 Peak intensity 2.500 cd/lm
 LEDs/each optic 1
 Light colour White
 Required components:
 C13083_PF-SOCKET
 C13723_MIRELLA-RZL

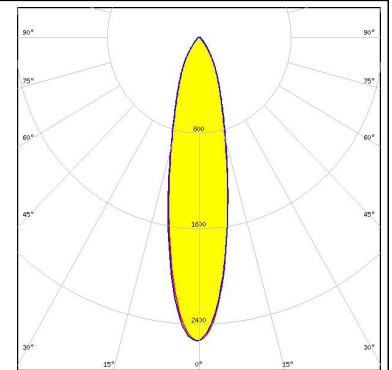

CITIZEN

LED CLU720/721
 FWHM 23.0°
 Efficiency 77 %
 Peak intensity 2.500 cd/lm
 LEDs/each optic 1
 Light colour White
 Required components:
 C13709_PF-SOCKET-VERO13-18
 C13333_MIRELLA-CL
 Bender Wirth: 433 Typ L1

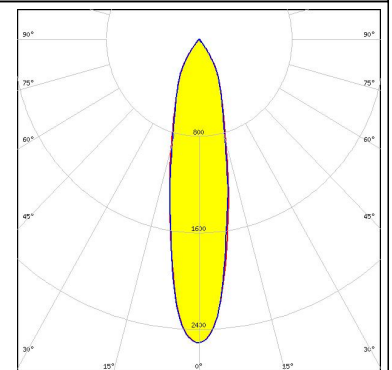
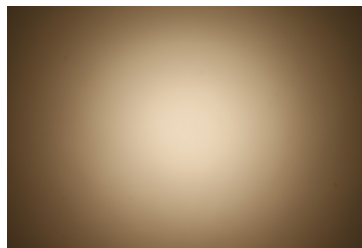

CITIZEN

LED CLU720/721
 FWHM 29.0°
 Efficiency 75 %
 Peak intensity 1.700 cd/lm
 LEDs/each optic 1
 Light colour White
 Required components:
 C13709_PF-SOCKET-VERO13-18
 C12479_MIRELLA-DL
 Bender Wirth: 433 Typ L1

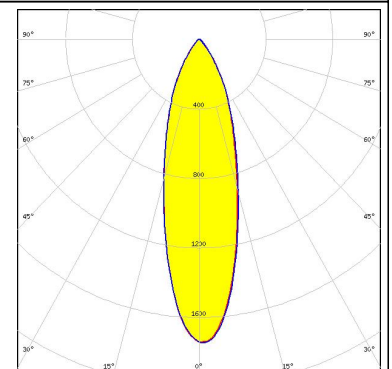
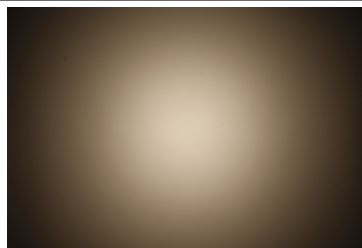

CITIZEN

LED CLU720/721
 FWHM 23.0°
 Efficiency 82 %
 Peak intensity 2.600 cd/lm
 LEDs/each optic 1
 Light colour White
 Required components:
 C13709_PF-SOCKET-VERO13-18
 Bender Wirth: 433 Typ L1

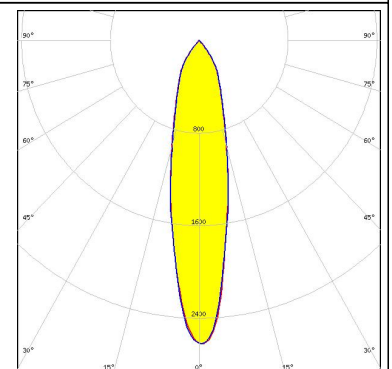
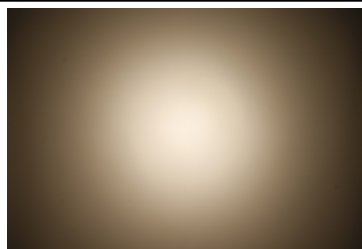

PHOTOMETRIC DATA (MEASURED):

CREE ⇄

LED CXA/B 13xx
 FWHM 15.0°
 Efficiency 81 %
 Peak intensity 5.400 cd/lm
 LEDs/each optic 1
 Light colour White
 Required components:
 C13761_PF-SOCKET-CXA15
 C12479_MIRELLA-DL

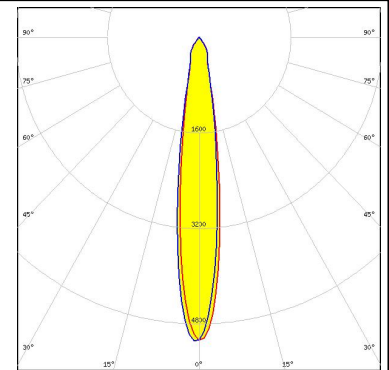

CREE ⇄

LED CXA/B 13xx
 FWHM 12.0°
 Efficiency 82 %
 Peak intensity 8.500 cd/lm
 LEDs/each optic 1
 Light colour White
 Required components:
 C13761_PF-SOCKET-CXA15
 C13333_MIRELLA-CL



CREE ⇄

LED CXA/B 13xx
 FWHM 12.0°
 Efficiency 87 %
 Peak intensity 9.500 cd/lm
 LEDs/each optic 1
 Light colour White
 Required components:
 C13761_PF-SOCKET-CXA15

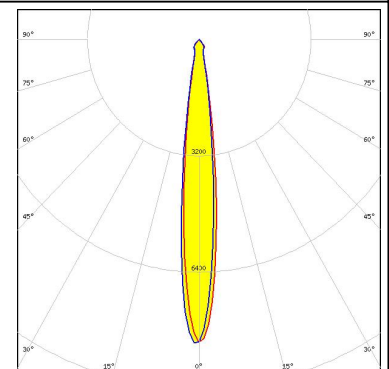
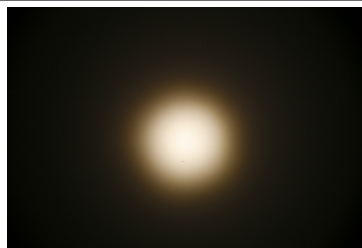

CREE ⇄

LED CXA/B 15xx
 FWHM 27.0°
 Efficiency 82 %
 Peak intensity 2.300 cd/lm
 LEDs/each optic 1
 Light colour White
 Required components:
 C13761_PF-SOCKET-CXA15
 C13723_MIRELLA-RZL

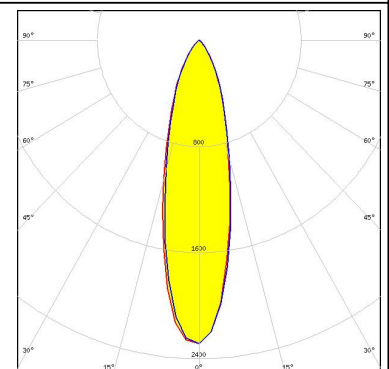

PHOTOMETRIC DATA (MEASURED):

CREE 

LED CXA/B 15xx
 FWHM 21.0°
 Efficiency 87 %
 Peak intensity 3.400 cd/lm
 LEDs/each optic 1
 Light colour White
 Required components:
 C13761_PF-SOCKET-CXA15
 C12479_MIRELLA-DL

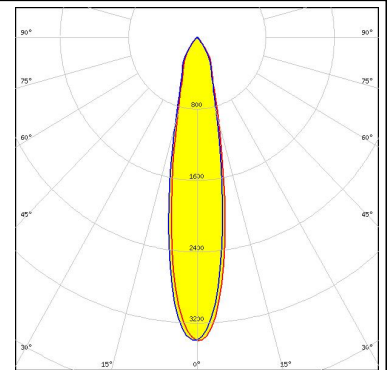

CREE 

LED CXA/B 15xx
 FWHM 19.0°
 Efficiency 79 %
 Peak intensity 3.300 cd/lm
 LEDs/each optic 1
 Light colour White
 Required components:
 C13709_PF-SOCKET-VERO13-18
 C13333_MIRELLA-CL
 Bender Wirth: 441 Typ L1

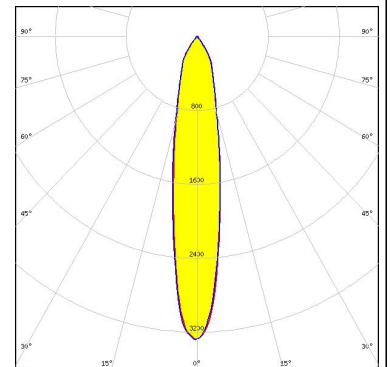
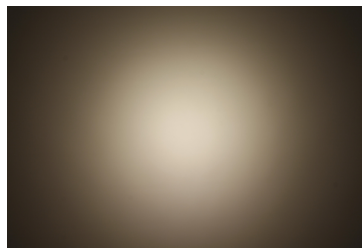

CREE 

LED CXA/B 15xx
 FWHM 26.0°
 Efficiency 77 %
 Peak intensity 2.100 cd/lm
 LEDs/each optic 1
 Light colour White
 Required components:
 C13709_PF-SOCKET-VERO13-18
 C12479_MIRELLA-DL
 Bender Wirth: 441 Typ L1

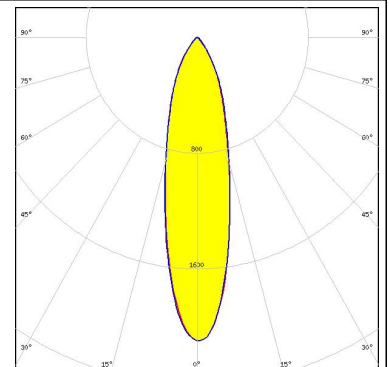
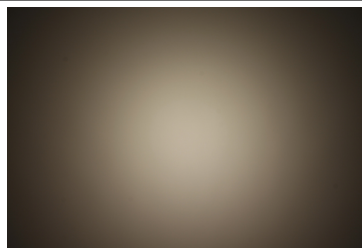

CREE 

LED CXA/B 15xx
 FWHM 20.0°
 Efficiency 84 %
 Peak intensity 3.300 cd/lm
 LEDs/each optic 1
 Light colour White
 Required components:
 C13709_PF-SOCKET-VERO13-18
 Bender Wirth: 441 Typ L1

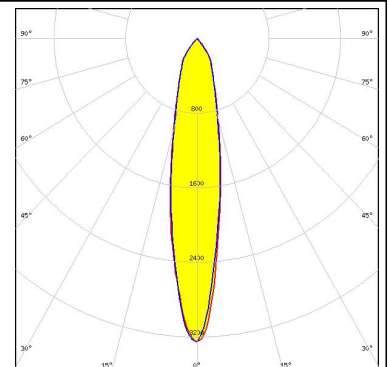
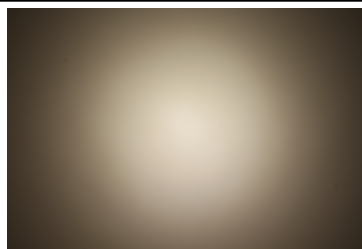

PHOTOMETRIC DATA (MEASURED):



LED CXA/B 15xx
 FWHM 19.0°
 Efficiency 84 %
 Peak intensity 4.300 cd/lm
 LEDs/each optic 1
 Light colour White
 Required components:
 C13761_PF-SOCKET-CXA15
 C13333_MIRELLA-CL



LED CXA/B 15xx
 FWHM 18.0°
 Efficiency 91 %
 Peak intensity 4.400 cd/lm
 LEDs/each optic 1
 Light colour White
 Required components:
 C13761_PF-SOCKET-CXA15

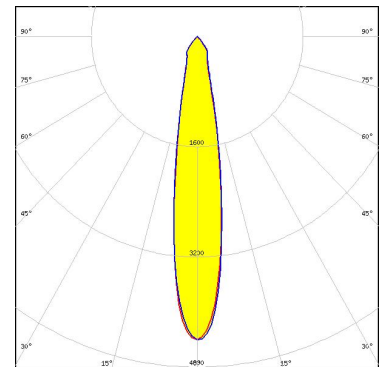

LED CXA/B 1816 & CXA/B 1820 & CXA 1850
 FWHM 23.0°
 Efficiency 89 %
 Peak intensity 2.800 cd/lm
 LEDs/each optic 1
 Light colour White
 Required components:
 IDEAL: 50-2101CR + 50-2100MR

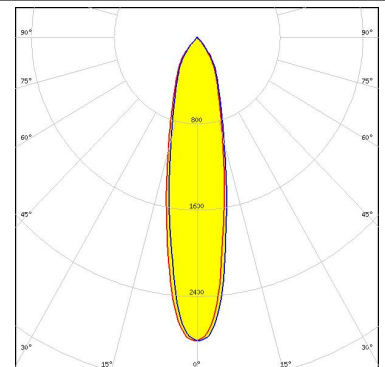
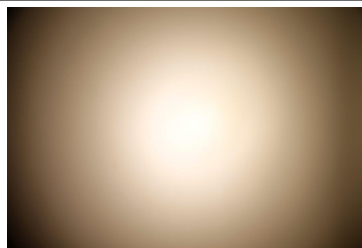

LED CXA/B 1816 & CXA/B 1820 & CXA 1850
 FWHM 25.0°
 Efficiency 85 %
 Peak intensity 2.700 cd/lm
 LEDs/each optic 1
 Light colour White
 Required components:
 C14115_PF-SOCKET-CXA15-18

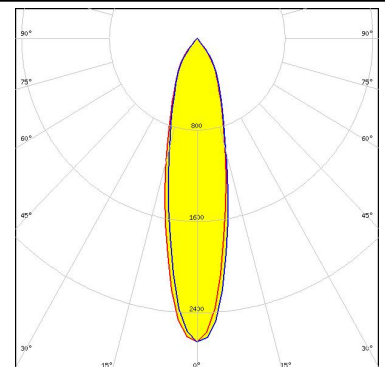
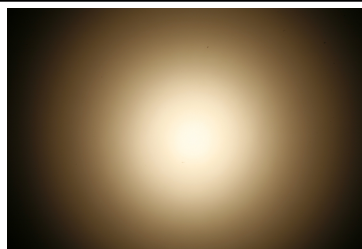

PHOTOMETRIC DATA (MEASURED):



LED MHD-E/G
 FWHM 24.0°
 Efficiency 84 %
 Peak intensity 2.300 cd/lm
 LEDs/each optic 1
 Light colour White
 Required components:
 C13083_PF-SOCKET
 C13723_MIRELLA-RZL

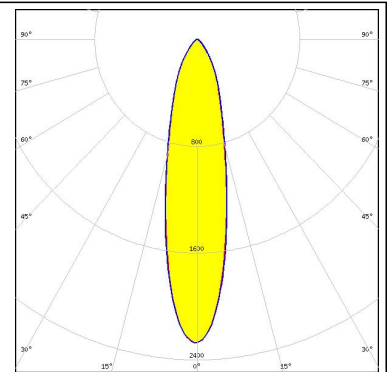
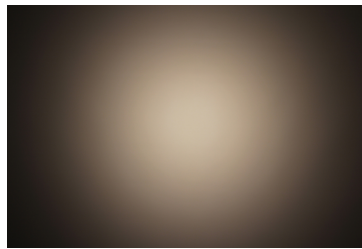

LED MHD-E/G
 FWHM 15.0°
 Efficiency 87 %
 Peak intensity 5.400 cd/lm
 LEDs/each optic 1
 Light colour White
 Required components:
 C13083_PF-SOCKET
 C13333_MIRELLA-CL

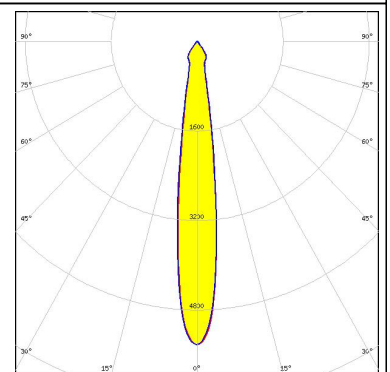

LED MHD-E/G
 FWHM 17.0°
 Efficiency 87 %
 Peak intensity 4.100 cd/lm
 LEDs/each optic 1
 Light colour White
 Required components:
 C13083_PF-SOCKET
 C12479_MIRELLA-DL

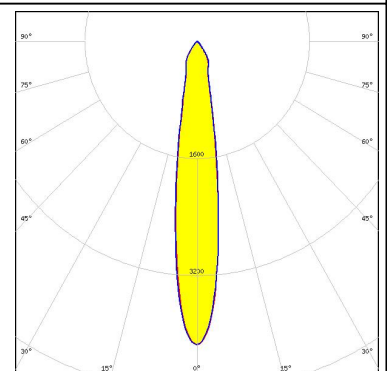
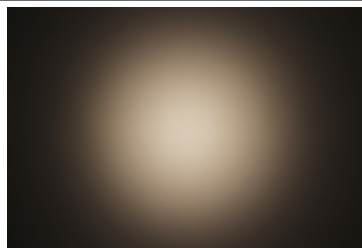

LED MHD-E/G
 FWHM 14.0°
 Efficiency 93 %
 Peak intensity 6.100 cd/lm
 LEDs/each optic 1
 Light colour White
 Required components:
 C13083_PF-SOCKET

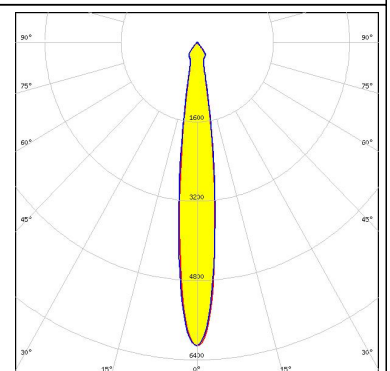

PHOTOMETRIC DATA (MEASURED):



LED MK-R
 FWHM 15.0°
 Efficiency 82 %
 Peak intensity 4.900 cd/lm
 LEDs/each optic 1
 Light colour White
 Required components:
 C13083_PF-SOCKET
 C12479_MIRELLA-DL

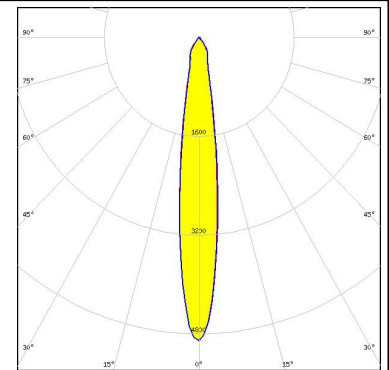
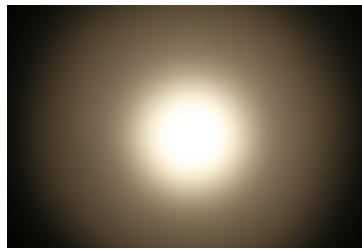

LED MK-R
 FWHM 12.0°
 Efficiency 87 %
 Peak intensity 8.100 cd/lm
 LEDs/each optic 1
 Light colour White
 Required components:
 C13083_PF-SOCKET

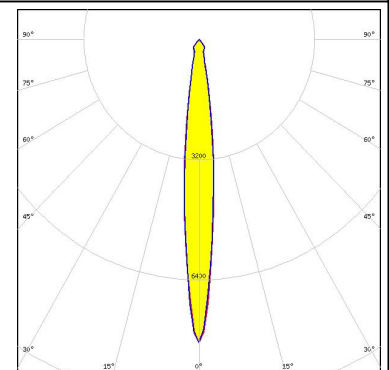

LED MT-G
 FWHM 18.0°
 Efficiency 86 %
 Peak intensity 5.500 cd/lm
 LEDs/each optic 1
 Light colour White
 Required components:
 C13083_PF-SOCKET
 C13333_MIRELLA-CL



LED MT-G
 FWHM 19.0°
 Efficiency 85 %
 Peak intensity 4.400 cd/lm
 LEDs/each optic 1
 Light colour White
 Required components:
 C13083_PF-SOCKET
 C12479_MIRELLA-DL



PHOTOMETRIC DATA (MEASURED):

CREE ⇄

LED MT-G
FWHM 17.0°
Efficiency 90 %
Peak intensity 5.300 cd/lm
LEDs/each optic 1
Light colour White
Required components:
C13083_PF-SOCKET

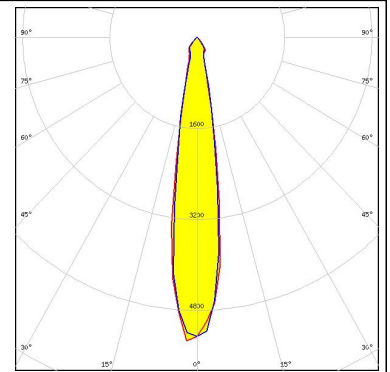

CREE ⇄

LED MT-G2
FWHM 18.0°
Efficiency 85 %
Peak intensity 4.600 cd/lm
LEDs/each optic 1
Light colour White
Required components:
C13083_PF-SOCKET
C12479_MIRELLA-DL



CREE ⇄

LED MT-G2
FWHM 18.0°
Efficiency 88 %
Peak intensity 4.200 cd/lm
LEDs/each optic 1
Light colour White
Required components:
C13083_PF-SOCKET

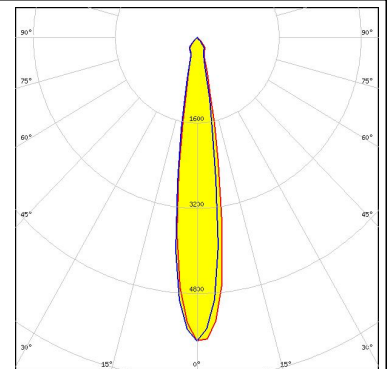

CREE ⇄

LED MT-G2
FWHM 16.0°
Efficiency 84 %
Peak intensity 5.800 cd/lm
LEDs/each optic 1
Light colour White
Required components:
C13083_PF-SOCKET
C13333_MIRELLA-CL



PHOTOMETRIC DATA (MEASURED):

CREE

LED XHP50
 FWHM 22.0°
 Efficiency 81 %
 Peak intensity 2.600 cd/lm
 LEDs/each optic 1
 Light colour White
 Required components:
 C13083_PF-SOCKET
 C13723_MIRELLA-RZL

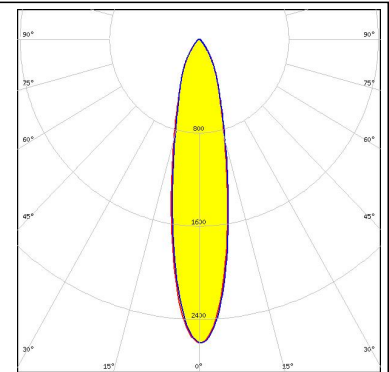
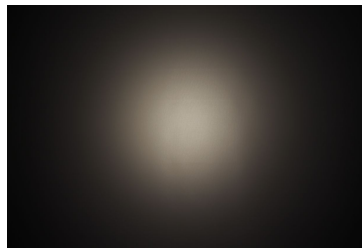

CREE

LED XHP50
 FWHM 12.0°
 Efficiency 84 %
 Peak intensity 7.600 cd/lm
 LEDs/each optic 1
 Light colour White
 Required components:
 C13083_PF-SOCKET
 C13333_MIRELLA-CL

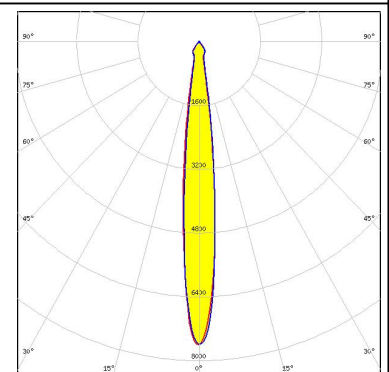

CREE

LED XHP50
 FWHM 11.0°
 Efficiency 89 %
 Peak intensity 9.200 cd/lm
 LEDs/each optic 1
 Light colour White
 Required components:
 C13083_PF-SOCKET

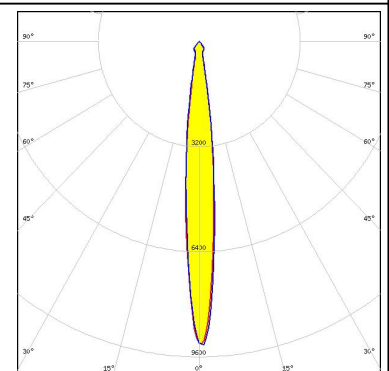
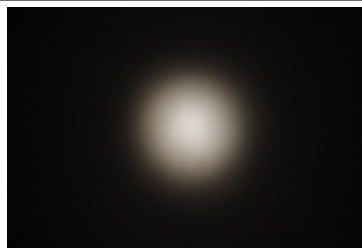

CREE

LED XHP50
 FWHM 15.0°
 Efficiency 85 %
 Peak intensity 5.300 cd/lm
 LEDs/each optic 1
 Light colour White
 Required components:
 C13083_PF-SOCKET
 C12479_MIRELLA-DL

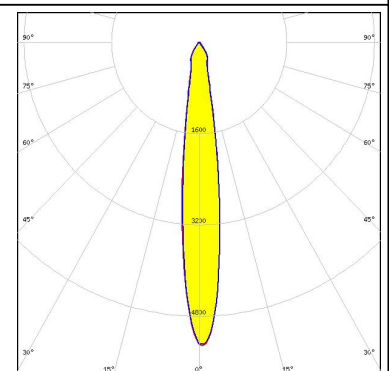

PHOTOMETRIC DATA (MEASURED):

CREE 

LED XHP70
 FWHM 24.0°
 Efficiency 81 %
 Peak intensity 2.400 cd/lm
 LEDs/each optic 1
 Light colour White
 Required components:
 C13083_PF-SOCKET
 C13723_MIRELLA-RZL

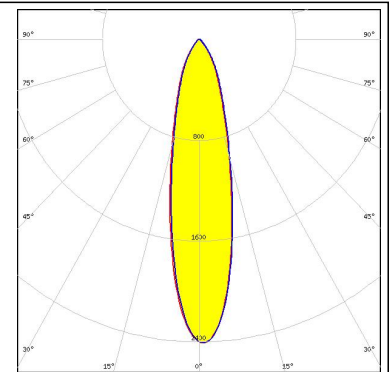
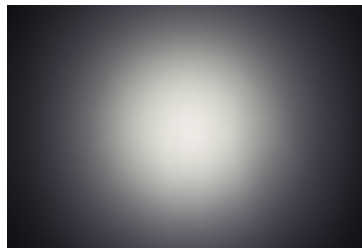

CREE 

LED XHP70
 FWHM 16.0°
 Efficiency 83 %
 Peak intensity 5.300 cd/lm
 LEDs/each optic 1
 Light colour White
 Required components:
 C13083_PF-SOCKET
 C13333_MIRELLA-CL

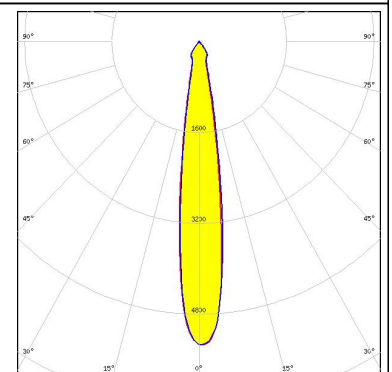

CREE 

LED XHP70
 FWHM 17.0°
 Efficiency 84 %
 Peak intensity 4.300 cd/lm
 LEDs/each optic 1
 Light colour White
 Required components:
 C13083_PF-SOCKET
 C12479_MIRELLA-DL

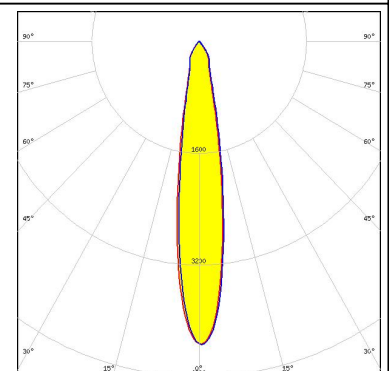
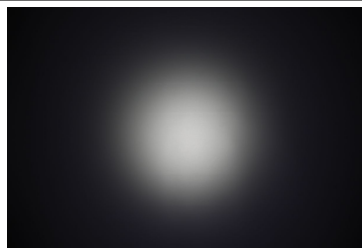

CREE 

LED XHP70
 FWHM 15.0°
 Efficiency 89 %
 Peak intensity 0.630 cd/lm
 LEDs/each optic 1
 Light colour White
 Required components:
 C13083_PF-SOCKET

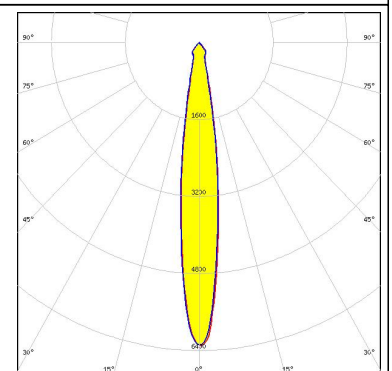

PHOTOMETRIC DATA (MEASURED):



LED XM-L RGB
 FWHM 22.0°
 Efficiency 80 %
 Peak intensity 3.060 cd/lm
 LEDs/each optic 1
 Light colour White
 Required components:
 C13083_PF-SOCKET
 C13723_MIRELLA-RZL

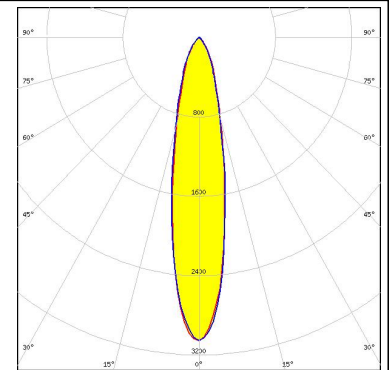
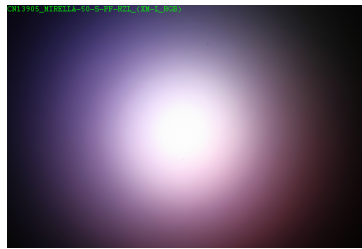

LED XQ-E HI
 FWHM 21.0°
 Efficiency 86 %
 Peak intensity 3.140 cd/lm
 LEDs/each optic 4
 Light colour RGBW
 Required components:
 C13083_PF-SOCKET
 C13723_MIRELLA-RZL

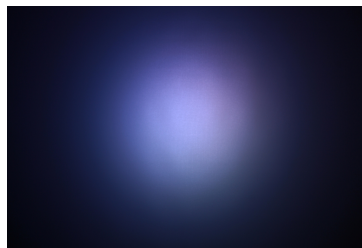

LED COB 4W
 FWHM 14.0°
 Efficiency 86 %
 Peak intensity 4.400 cd/lm
 LEDs/each optic 1
 Light colour White
 Required components:
 C13083_PF-SOCKET
 C12479_MIRELLA-DL



LED COB 4W
 FWHM 14.0°
 Efficiency 91 %
 Peak intensity 6.700 cd/lm
 LEDs/each optic 1
 Light colour White
 Required components:
 C13083_PF-SOCKET



PHOTOMETRIC DATA (MEASURED):

LG Innotek

LED COB 4W
 FWHM 13.0°
 Efficiency 84 %
 Peak intensity 7.800 cd/lm
 LEDs/each optic 1
 Light colour White
 Required components:
 C13083_PF-SOCKET
 C13333_MIRELLA-CL

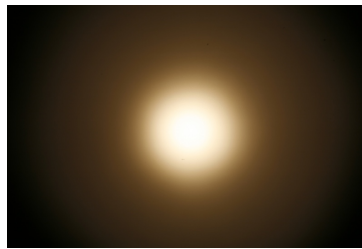

LUMILEDS

LED LUXEON CoB 1202/1203
 FWHM 20.0°
 Efficiency 84 %
 Peak intensity 3.200 cd/lm
 LEDs/each optic 1
 Light colour White
 Required components:
 C13709_PF-SOCKET-VERO13-18
 Bender Wirth: 438 Typ L1

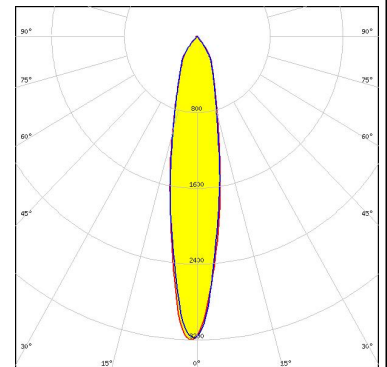
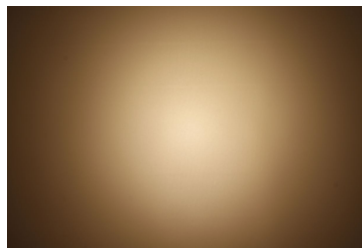

LUMILEDS

LED LUXEON CoB 1202/1203
 FWHM 22.0°
 Efficiency 83 %
 Peak intensity 2.900 cd/lm
 LEDs/each optic 1
 Light colour White
 Required components:
 C12479_MIRELLA-DL
 IDEAL: 50-2100NC +50-2100MR

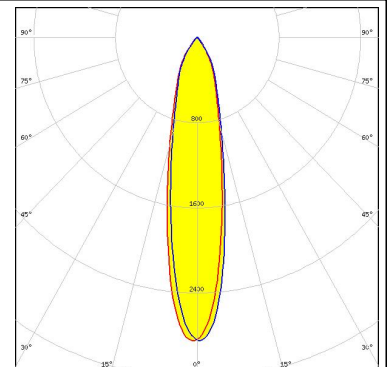
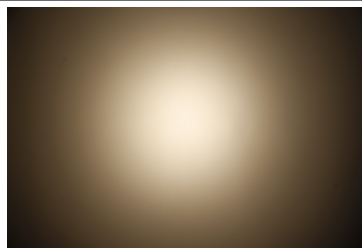



LUMILEDS

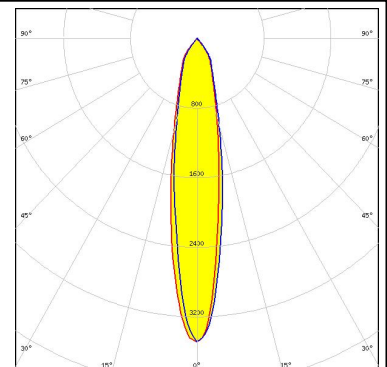
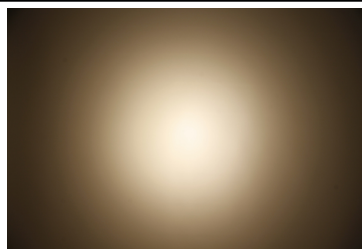

LED LUXEON CoB 1202/1203
 FWHM 19.0°
 Efficiency 88 %
 Peak intensity 3.500 cd/lm
 LEDs/each optic 1
 Light colour White
 Required components:
 IDEAL: 50-2100NC +50-2100MR

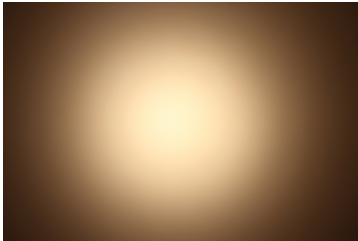
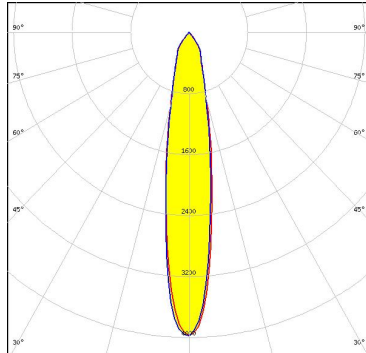
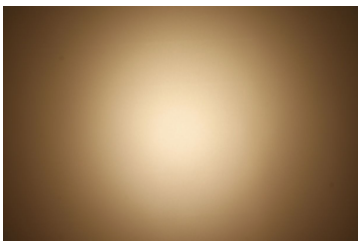
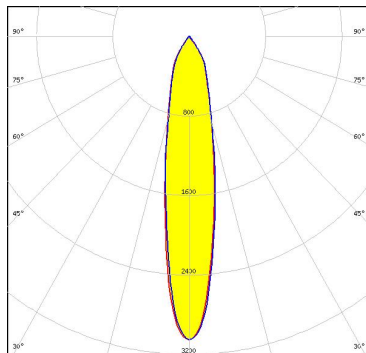
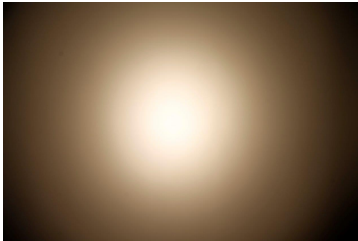
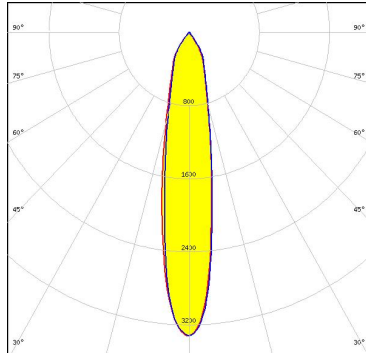

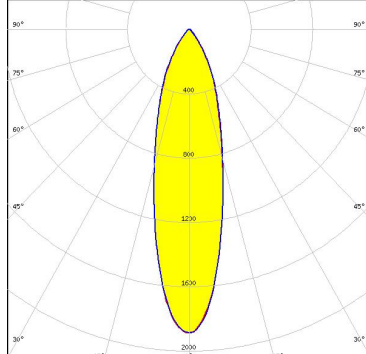
PHOTOMETRIC DATA (MEASURED):

<p>LUMILEDS</p> <p>LED LUXEON CoB 1202/1203 FWHM 19.0° Efficiency 87 % Peak intensity 4.000 cd/lm LEDs/each optic 1 Light colour White Required components: C14037_PF-NSX-SOCKET</p>		
<p>LUMILEDS</p> <p>LED LUXEON CoB 1202/1203 FWHM 20.0° Efficiency 78 % Peak intensity 3.100 cd/lm LEDs/each optic 1 Light colour White Required components: C13709_PF-SOCKET-VERO13-18 C13333_MIRELLA-CL Bender Wirth: 438 Typ L1</p>		
<p>LUMILEDS</p> <p>LED LUXEON CoB 1202/1203 FWHM 19.0° Efficiency 82 % Peak intensity 3.300 cd/lm LEDs/each optic 1 Light colour White Required components: C13333_MIRELLA-CL IDEAL: 50-2100NC +50-2100MR</p>		
<p>LUMILEDS</p> <p>LED LUXEON CoB 1202/1203 FWHM 27.0° Efficiency 76 % Peak intensity 1.900 cd/lm LEDs/each optic 1 Light colour White Required components: C13709_PF-SOCKET-VERO13-18 C12479_MIRELLA-DL Bender Wirth: 438 Typ L1</p>		

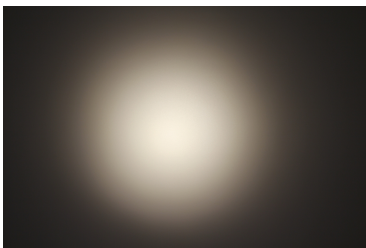
PHOTOMETRIC DATA (MEASURED):

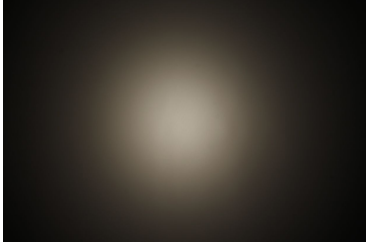
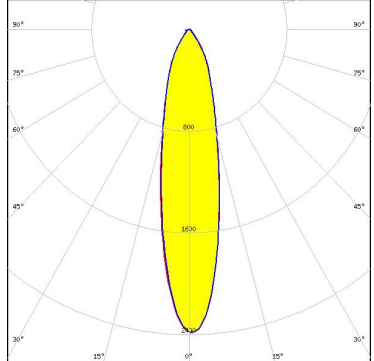
<p>LUMILEDS</p> <p>LED LUXEON CoB 1202s FWHM 13.0° Efficiency 84 % Peak intensity 7.600 cd/lm LEDs/each optic 1 Light colour White Required components: C13761_PF-SOCKET-CXA15 C13333_MIRELLA-CL</p>	
<p>LUMILEDS</p> <p>LED LUXEON CoB 1202s FWHM 13.0° Efficiency 89 % Peak intensity 7.900 cd/lm LEDs/each optic 1 Light colour White Required components: C13761_PF-SOCKET-CXA15</p>	
<p>LUMILEDS</p> <p>LED LUXEON CoB 1202s FWHM 15.0° Efficiency 84 % Peak intensity 5.900 cd/lm LEDs/each optic 1 Light colour White Required components: C13761_PF-SOCKET-CXA15 C12479_MIRELLA-DL</p>	
<p>LUMILEDS</p> <p>LED LUXEON CoB 1202s FWHM 23.0° Efficiency 79 % Peak intensity 2.400 cd/lm LEDs/each optic 1 Light colour White Required components: C13709_PF-SOCKET-VERO13-18 C12479_MIRELLA-DL Bender Wirth: 452 Typ L1</p>	 

PHOTOMETRIC DATA (MEASURED):



LED LUXEON Z
 FWHM 21.0°
 Efficiency 78 %
 Peak intensity 3.200 cd/lm
 LEDs/each optic 4
 Light colour RGBW
 Required components:
 C13083_PF-SOCKET
 C13723_MIRELLA-RZL

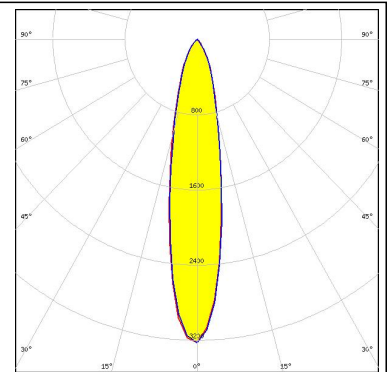

LED CxM-6 (12x13)
 FWHM 14.0°
 Efficiency 86 %
 Peak intensity 6.700 cd/lm
 LEDs/each optic 1
 Light colour White
 Required components:
 C13083_PF-SOCKET

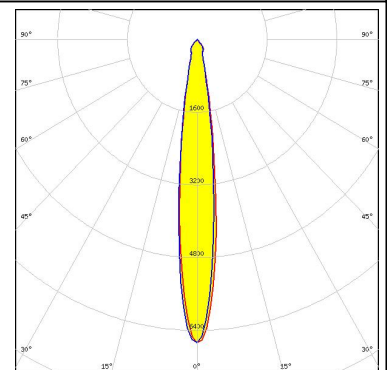

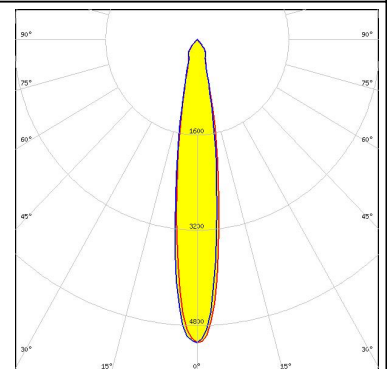

LED CXM-7 (13x13)
 FWHM 17.0°
 Efficiency 87 %
 Peak intensity 5.100 cd/lm
 LEDs/each optic 1
 Light colour White
 Required components:
 C13083_PF-SOCKET



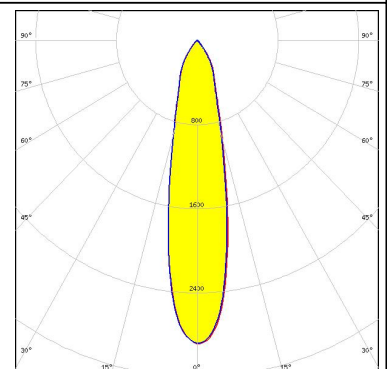
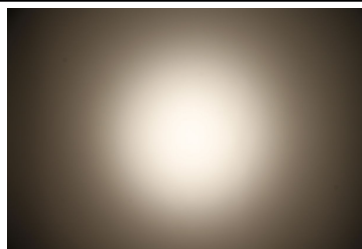

LED CxM-9 (13.5x13.5)
 FWHM 23.0°
 Efficiency 86 %
 Peak intensity 2.900 cd/lm
 LEDs/each optic 1
 Light colour White
 Required components:
 C13083_PF-SOCKET
 C12479_MIRELLA-DL

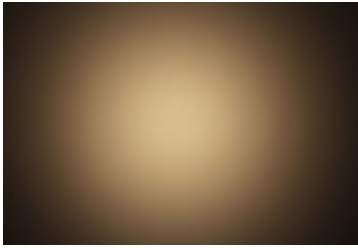
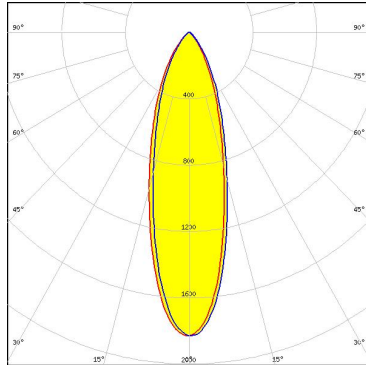
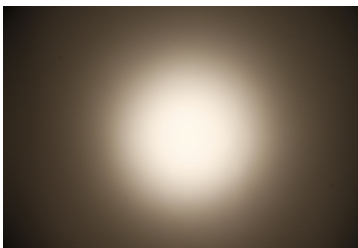
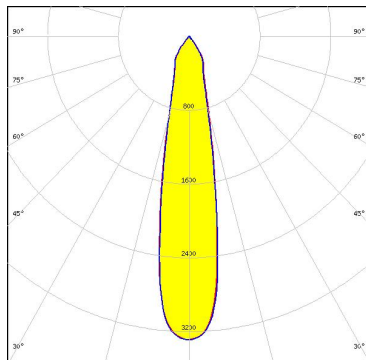

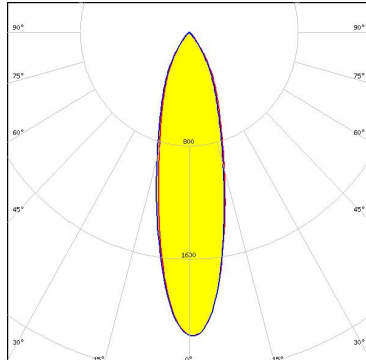
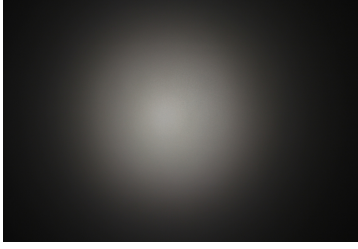
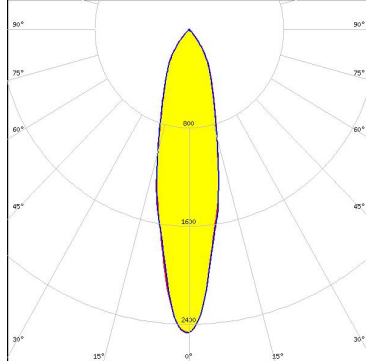

PHOTOMETRIC DATA (MEASURED):

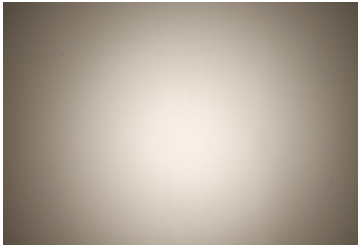
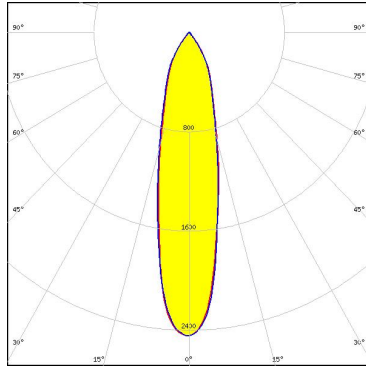
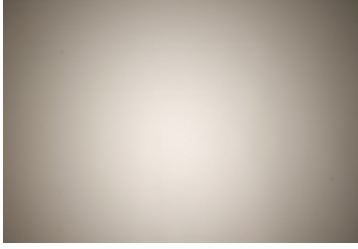
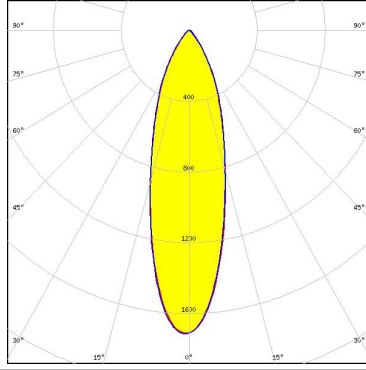
<p>LUMINUS</p> <p>LED CxM-9 (13.5x13.5) FWHM 30.0° Efficiency 81 % Peak intensity 1.800 cd/lm LEDs/each optic 1 Light colour White Required components: C13083_PF-SOCKET C13723_MIRELLA-RZL</p>		
<p>LUMINUS</p> <p>LED CxM-9 (13.5x13.5) FWHM 21.0° Efficiency 85 % Peak intensity 3.300 cd/lm LEDs/each optic 1 Light colour White Required components: C13083_PF-SOCKET C13333_MIRELLA-CL</p>		
<p>NICHIA</p> <p>LED COB L-Type (LES 11) FWHM 26.0° Efficiency 80 % Peak intensity 2.100 cd/lm LEDs/each optic 1 Light colour White Required components: C12479_MIRELLA-DL IDEAL: 50-2100NC +50-2100MR</p>		
<p>NICHIA</p> <p>LED COB L-Type (LES 11) FWHM 25.0° Efficiency 83 % Peak intensity 2.500 cd/lm LEDs/each optic 1 Light colour White Required components: IDEAL: 50-2100NC +50-2100MR</p>		

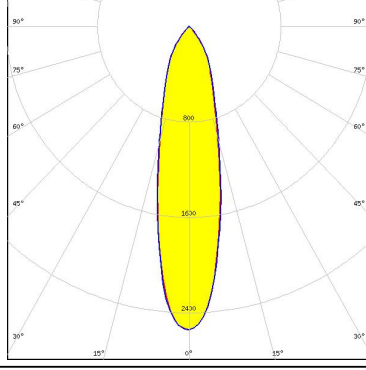
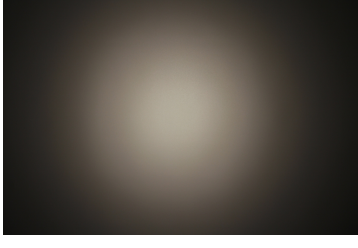
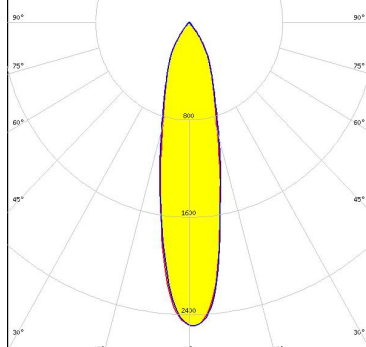
PHOTOMETRIC DATA (MEASURED):

<p>NICHIA</p> <p>LED COB L-Type (LES 11) FWHM 24.0° Efficiency 78 % Peak intensity 2.400 cd/lm LEDs/each optic 1 Light colour White</p> <p>Required components: C13709_PF-SOCKET-VERO13-18 C13333_MIRELLA-CL Bender Wirth: 438 Typ L1</p>		
<p>NICHIA</p> <p>LED COB L-Type (LES 11) FWHM 30.0° Efficiency 76 % Peak intensity 1.700 cd/lm LEDs/each optic 1 Light colour White</p> <p>Required components: C13709_PF-SOCKET-VERO13-18 C12479_MIRELLA-DL Bender Wirth: 438 Typ L1</p>		
<p>NICHIA</p> <p>LED COB L-Type (LES 11) FWHM 25.0° Efficiency 86 % Peak intensity 2.540 cd/lm LEDs/each optic 1 Light colour White</p> <p>Required components: C14037_PF-NSX-SOCKET</p>		
<p>NICHIA</p> <p>LED COB L-Type (LES 11) FWHM 24.0° Efficiency 81 % Peak intensity 2.500 cd/lm LEDs/each optic 1 Light colour White</p> <p>Required components: C13333_MIRELLA-CL IDEAL: 50-2100NC +50-2100MR</p>		

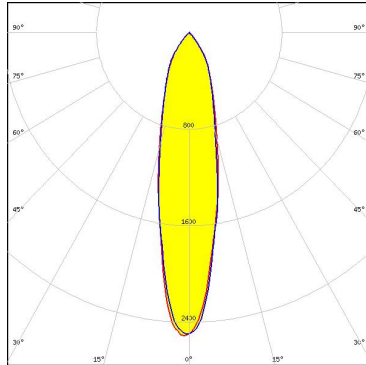
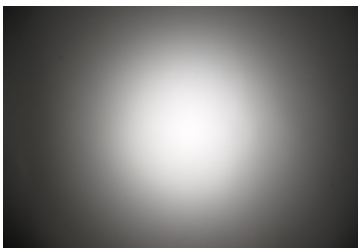
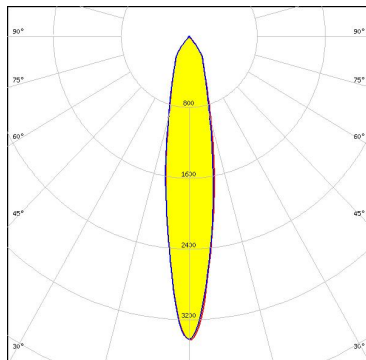
PHOTOMETRIC DATA (MEASURED):

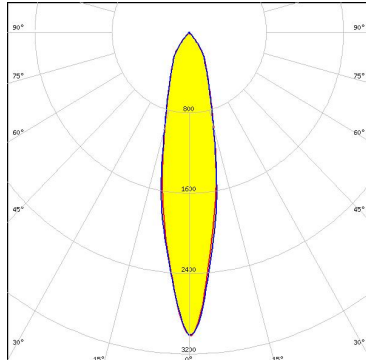
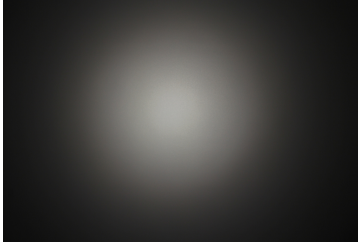
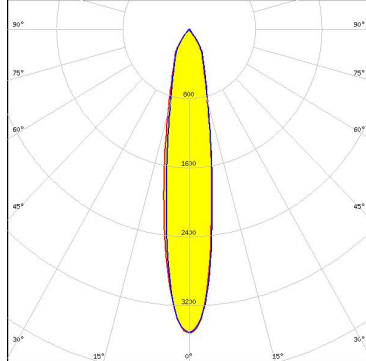
<p>NICHIA</p> <p>LED COB L-Type (LES 11) FWHM 24.0° Efficiency 81 % Peak intensity 2.500 cd/lm LEDs/each optic 1 Light colour White Required components: C13709_PF-SOCKET-VERO13-18 Bender Wirth: 438 Typ L1</p>		
<p>NICHIA</p> <p>LED COB L-Type (LES 9) FWHM 19.0° Efficiency 85 % Peak intensity 3.400 cd/lm LEDs/each optic 1 Light colour White Required components: C13709_PF-SOCKET-VERO13-18 Bender Wirth: 438 Typ L1</p>		
<p>NICHIA</p> <p>LED COB L-Type (LES 9) FWHM 22.0° Efficiency 84 % Peak intensity 3.000 cd/lm LEDs/each optic 1 Light colour White Required components: IDEAL: 50-2100NC +50-2100MR</p>		
<p>NICHIA</p> <p>LED COB L-Type (LES 9) FWHM 18.0° Efficiency 83 % Peak intensity 3.500 cd/lm LEDs/each optic 1 Light colour White Required components: C13333_MIRELLA-CL IDEAL: 50-2100NC +50-2100MR</p>		

PHOTOMETRIC DATA (MEASURED):



LED COB L-Type (LES 9)
 FWHM 18.0°
 Efficiency 80 %
 Peak intensity 3.300 cd/lm
 LEDs/each optic 1
 Light colour White
 Required components:
 C13709_PF-SOCKET-VERO13-18
 C13333_MIRELLA-CL
 Bender Wirth: 438 Typ L1

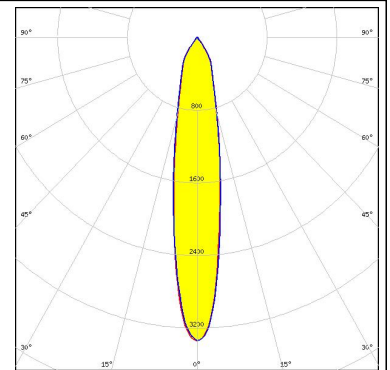

LED COB L-Type (LES 9)
 FWHM 19.0°
 Efficiency 88 %
 Peak intensity 3.900 cd/lm
 LEDs/each optic 1
 Light colour White
 Required components:
 C14037_PF-NSX-SOCKET

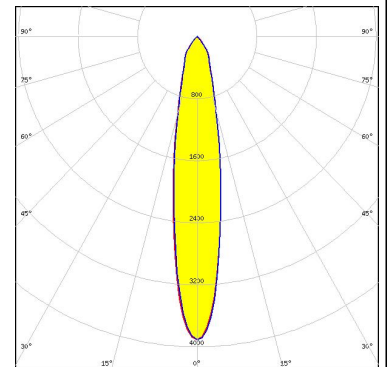



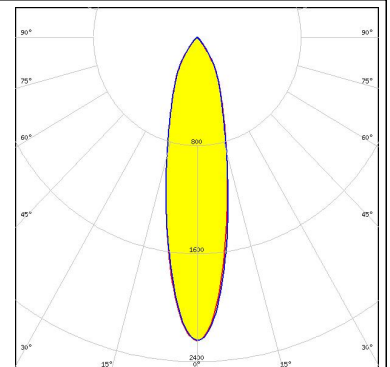
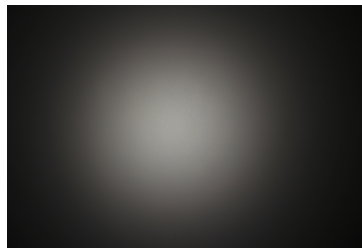

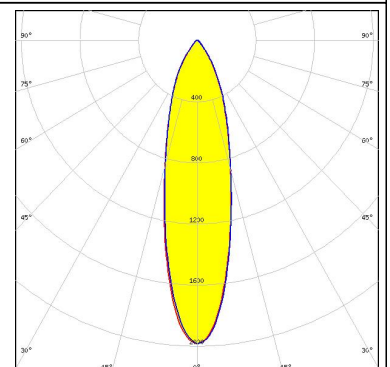
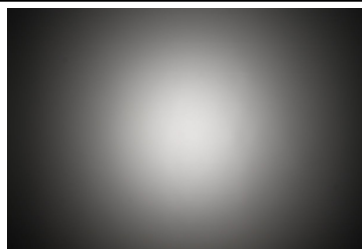

LED COB L-Type (LES 9)
 FWHM 24.0°
 Efficiency 78 %
 Peak intensity 2.200 cd/lm
 LEDs/each optic 1
 Light colour White
 Required components:
 C12479_MIRELLA-DL
 IDEAL: 50-2100NC +50-2100MR



LED COB L-Type (LES 9)
 FWHM 27.0°
 Efficiency 77 %
 Peak intensity 2.000 cd/lm
 LEDs/each optic 1
 Light colour White
 Required components:
 C13709_PF-SOCKET-VERO13-18
 C12479_MIRELLA-DL
 Bender Wirth: 438 Typ L1

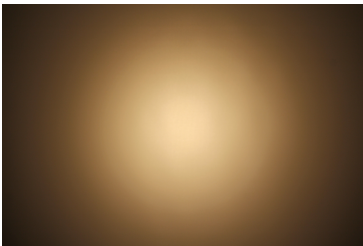

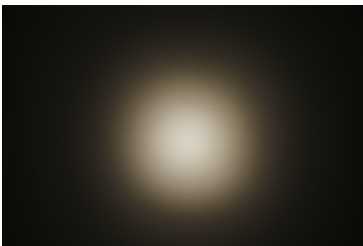
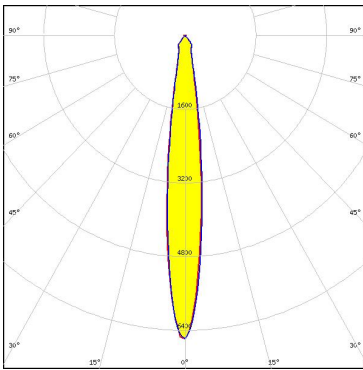
PHOTOMETRIC DATA (MEASURED):

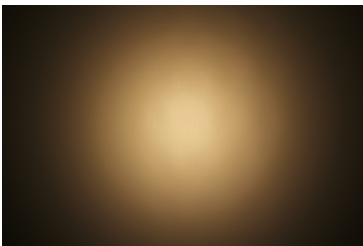
 LED NSCxL036A FWHM 16.0° Efficiency 86 % Peak intensity 5.060 cd/lm LEDs/each optic 1 Light colour White Required components: C14037_PF-NSX-SOCKET		
 LED Duris S10 FWHM 18.0° Efficiency 80 % Peak intensity 3.600 cd/lm LEDs/each optic 1 Light colour White Required components: C13083_PF-SOCKET C12479_MIRELLA-DL		
 LED Duris S10 FWHM 13.0° Efficiency 87 % Peak intensity 6.600 cd/lm LEDs/each optic 1 Light colour White Required components: C13083_PF-SOCKET		
 LED Duris S10 FWHM 22.0° Efficiency 82 % Peak intensity 3.000 cd/lm LEDs/each optic 1 Light colour White Required components: C13083_PF-SOCKET C13723_MIRELLA-RZL		

PHOTOMETRIC DATA (MEASURED):

OSRAM

Opto Semiconductors

LED Duris S10
 FWHM 13.0°
 Efficiency 81 %
 Peak intensity 6.500 cd/lm
 LEDs/each optic 1
 Light colour White
 Required components:
 C13083_PF-SOCKET
 C13333_MIRELLA-CL

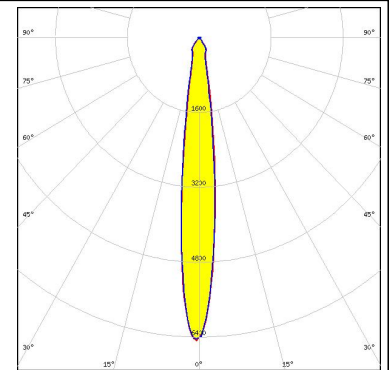

OSRAM

Opto Semiconductors

LED OSTAR Stage (S2WP)
 FWHM 21.0°
 Efficiency 83 %
 Peak intensity 3.340 cd/lm
 LEDs/each optic 1
 Light colour White
 Required components:
 C13083_PF-SOCKET
 C13723_MIRELLA-RZL

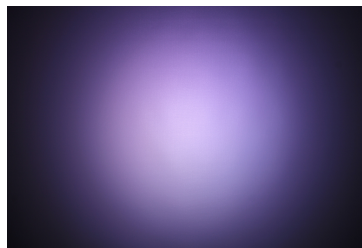

OSRAM

Opto Semiconductors

LED Ostar-SMT RGB
 FWHM 20.0°
 Efficiency 82 %
 Peak intensity 3.400 cd/lm
 LEDs/each optic 1
 Light colour White
 Required components:
 C13083_PF-SOCKET
 C13723_MIRELLA-RZL

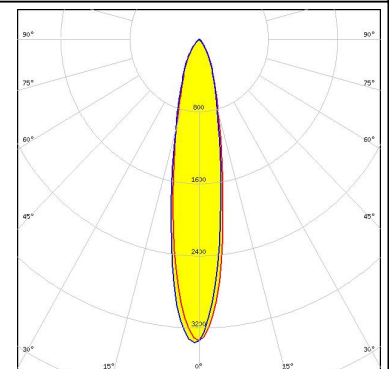
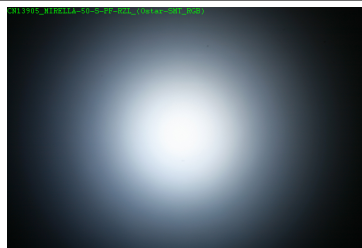



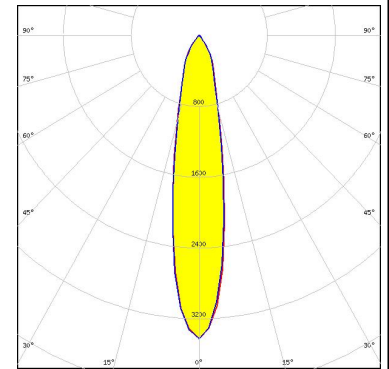
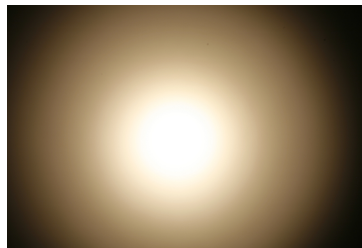

SEOUL SEMICONDUCTOR

LED ZC4/6
 FWHM 21.0°
 Efficiency 83 %
 Peak intensity 3.400 cd/lm
 LEDs/each optic 1
 Light colour White
 Required components:
 C13083_PF-SOCKET
 C12479_MIRELLA-DL

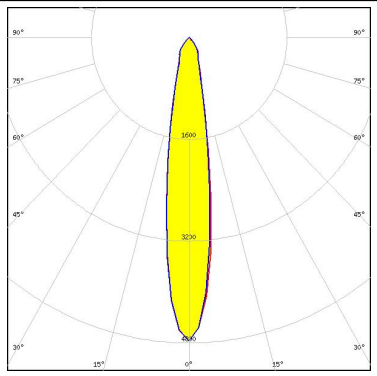

PHOTOMETRIC DATA (MEASURED):

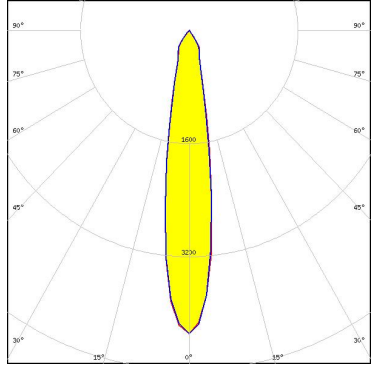
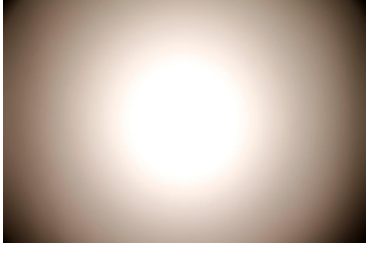
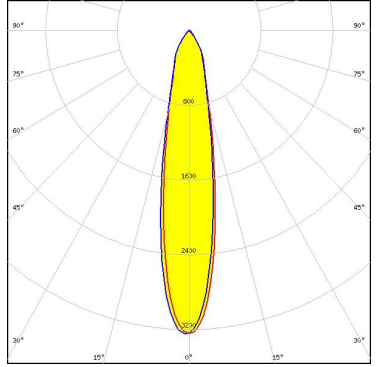
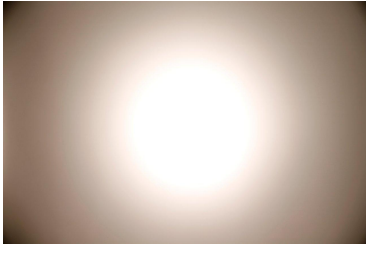
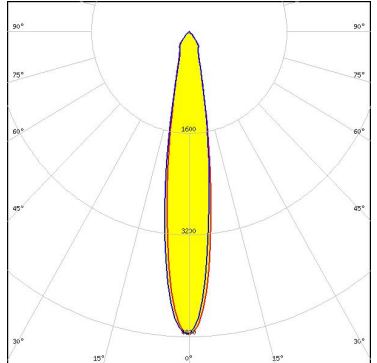
<p> SEUL SEMICONDUCTOR</p> <p>LED ZC4/6 FWHM 18.0° Efficiency 88 % Peak intensity 4.800 cd/lm LEDs/each optic 1 Light colour White Required components: C13083_PF-SOCKET</p>		
<p> SEUL SEMICONDUCTOR</p> <p>LED ZC4/6 FWHM 19.0° Efficiency 83 % Peak intensity 4.300 cd/lm LEDs/each optic 1 Light colour White Required components: C13083_PF-SOCKET C13333_MIRELLA-CL</p>		
<p>SHARP</p> <p>LED Mini Zenigata (GW6BM) FWHM 20.0° Efficiency 84 % Peak intensity 3.200 cd/lm LEDs/each optic 1 Light colour White Required components: C13083_PF-SOCKET C12479_MIRELLA-DL</p>		
<p>SHARP</p> <p>LED Mini Zenigata (GW6BM) FWHM 17.0° Efficiency 91 % Peak intensity 4.800 cd/lm LEDs/each optic 1 Light colour White Required components: C13083_PF-SOCKET</p>		

PHOTOMETRIC DATA (MEASURED):

TRIDONIC

LED SLE G5 LES11
FWHM 21.0°
Efficiency 88 %
Peak intensity 3.390 cd/lm
LEDs/each optic 1
Light colour White
Required components:
C13083_PF-SOCKET

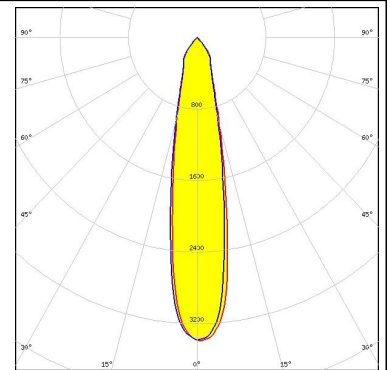

TRIDONIC

LED SLE G5 LES6
FWHM 12.0°
Efficiency 89 %
Peak intensity 8.980 cd/lm
LEDs/each optic 1
Light colour White
Required components:
C13083_PF-SOCKET

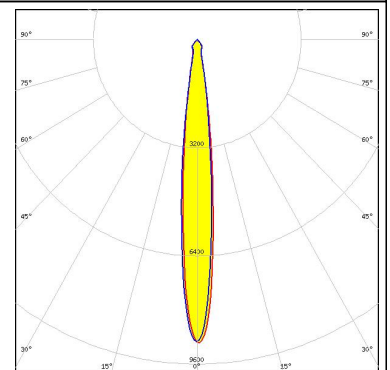

XICATO

LED XTM - 9mm LES
FWHM 20.0°
Efficiency 82 %
Peak intensity 3.200 cd/lm
LEDs/each optic 1
Light colour White
Required components:
C14636_XTM-PF-ADAPTER

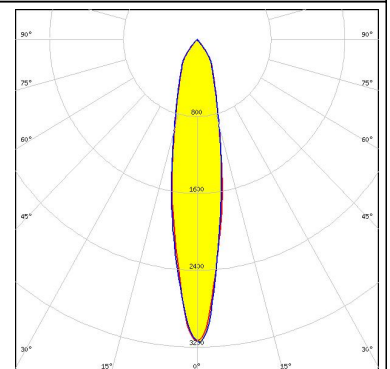
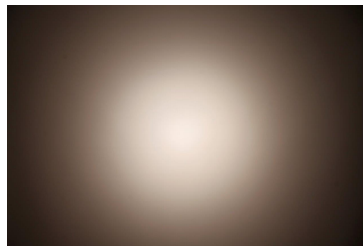

PHOTOMETRIC DATA (SIMULATED):



LED XHP50.2
FWHM 11.0°
Efficiency 90 %
Peak intensity 11.200 cd/lm
LEDs/each optic 1
Light colour White
Required components:

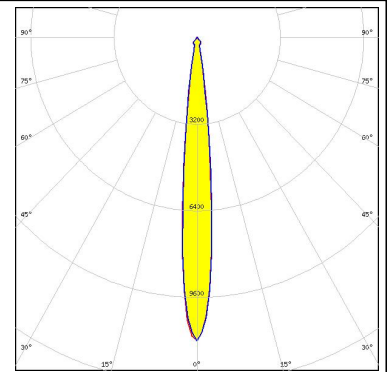

LED LUXEON CoB Compact
FWHM 23.0°
Efficiency 79 %
Peak intensity 2.400 cd/lm
LEDs/each optic 1
Light colour White
Required components:
C13709_PF-SOCKET-VERO13-18
C12479_MIRELLA-DL
Bender Wirth: 452 Typ L1



LED LUXEON CoB Compact
FWHM 13.0°
Efficiency 84 %
Peak intensity 7.600 cd/lm
LEDs/each optic 1
Light colour White
Required components:
C13761_PF-SOCKET-CXA15
C13333_MIRELLA-CL



LED LUXEON CoB Compact
FWHM 15.0°
Efficiency 84 %
Peak intensity 4.800 cd/lm
LEDs/each optic 1
Light colour White
Required components:
C13761_PF-SOCKET-CXA15
C12479_MIRELLA-DL

PHOTOMETRIC DATA (SIMULATED):

LUMILEDS

LED LUXEON CoB Compact
 FWHM 13.0°
 Efficiency 89 %
 Peak intensity 7.900 cd/lm
 LEDs/each optic 1
 Light colour White
 Required components:
 C13761_PF-SOCKET-CXA15

LUMILEDS

LED LUXEON K4
 FWHM 24.0°
 Efficiency 88 %
 Peak intensity 2.880 cd/lm
 LEDs/each optic 1
 Light colour White
 Required components:
 C13761_PF-SOCKET-CXA15

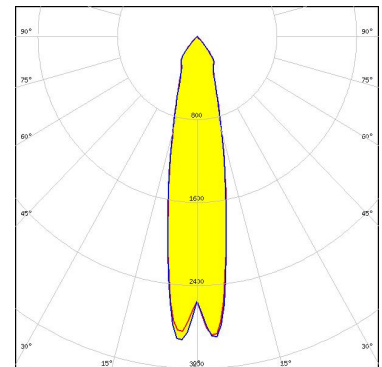

LUMILEDS

LED LUXEON K4
 FWHM 42.0°
 Efficiency 84 %
 Peak intensity 1.210 cd/lm
 LEDs/each optic 1
 Light colour White
 Required components:
 C13761_PF-SOCKET-CXA15
 C12479_MIRELLA-DL

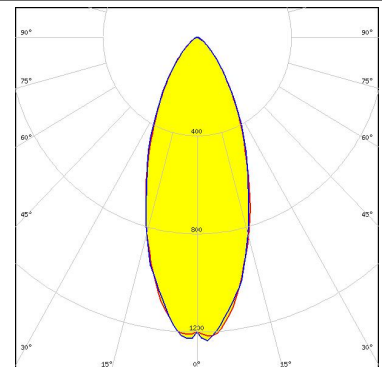

LUMINUS

LED CxM-14 (19x19)
 FWHM 33.0°
 Efficiency 69 %
 Peak intensity 1.400 cd/lm
 LEDs/each optic 1
 Light colour White
 Required components:
 C13709_PF-SOCKET-VERO13-18
 C12479_MIRELLA-DL
 Bender Wirth: 433 Typ L1

PHOTOMETRIC DATA (SIMULATED):



LED CxM-14 (19x19)
FWHM 29.0°
Efficiency 76 %
Peak intensity 1.800 cd/lm
LEDs/each optic 1
Light colour White
Required components:
C13709_PF-SOCKET-VERO13-18



LED CxM-14 (19x19)
FWHM 31.0°
Efficiency 72 %
Peak intensity 1.700 cd/lm
LEDs/each optic 1
Light colour White
Required components:
C13709_PF-SOCKET-VERO13-18
C13333_MIRELLA-CL
Bender Wirth: 433 Typ L1



LED CxM-9 (13.5x13.5)
FWHM 21.0°
Efficiency 84 %
Peak intensity 3.100 cd/lm
LEDs/each optic 1
Light colour White
Required components:
C13709_PF-SOCKET-VERO13-18
Bender Wirth: 434 Typ L1



LED CxM-9 (13.5x13.5)
FWHM 20.0°
Efficiency 80 %
Peak intensity 3.100 cd/lm
LEDs/each optic 1
Light colour White
Required components:
C13709_PF-SOCKET-VERO13-18
C13333_MIRELLA-CL
Bender Wirth: 434 Typ L1

PHOTOMETRIC DATA (SIMULATED):



LED CxM-9 (13.5x13.5)
FWHM 27.0°
Efficiency 77 %
Peak intensity 2.000 cd/lm
LEDs/each optic 1
Light colour White
Required components:
C13709_PF-SOCKET-VERO13-18
C12479_MIRELLA-DL
Bender Wirth: 434 Typ L1



LED COB S-Type (LES 7)
FWHM 23.0°
Efficiency 79 %
Peak intensity 2.400 cd/lm
LEDs/each optic 1
Light colour White
Required components:
C13709_PF-SOCKET-VERO13-18
C12479_MIRELLA-DL
Bender Wirth: 452 Typ L1









LED COB S-Type (LES 7)
FWHM 19.0°
Efficiency 87 %
Peak intensity 3.900 cd/lm
LEDs/each optic 1
Light colour White
Required components:
C13709_PF-SOCKET-VERO13-18
Bender Wirth: 452 Typ L1

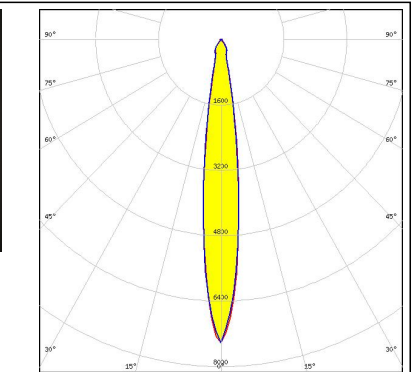

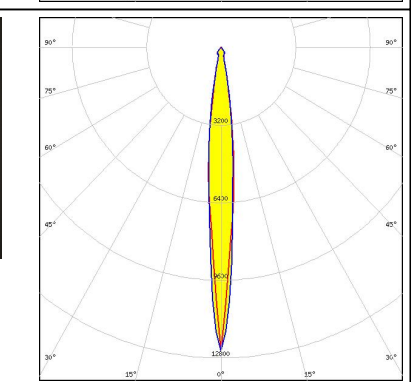
LED COB S-Type (LES 7)
FWHM 15.0°
Efficiency 83 %
Peak intensity 4.900 cd/lm
LEDs/each optic 1
Light colour White
Required components:
C13709_PF-SOCKET-VERO13-18
C13333_MIRELLA-CL
Bender Wirth: 452 Typ L1

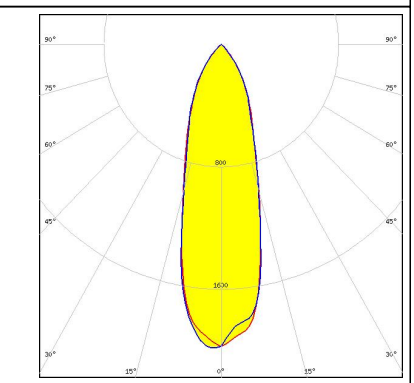
PHOTOMETRIC DATA (SIMULATED):

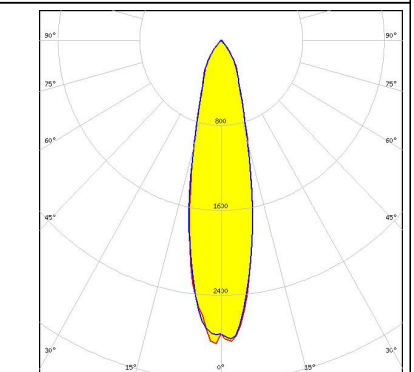
<p>OSRAM Opto Semiconductors</p> <p>LED Duris S8 FWHM 14.0° Efficiency 90 % Peak intensity 7.400 cd/lm LEDs/each optic 1 Light colour White Required components: C13083_PF-SOCKET C12479_MIRELLA-DL</p>		
<p>OSRAM Opto Semiconductors</p> <p>LED Duris S8 FWHM 9.5° Efficiency 94 % Peak intensity 12.500 cd/lm LEDs/each optic 1 Light colour White Required components: C13083_PF-SOCKET</p>		
<p>OSRAM Opto Semiconductors</p> <p>LED Soleriq S15 FWHM 28.0° Efficiency 85 % Peak intensity 1.990 cd/lm LEDs/each optic 1 Light colour White Required components: C13709_PF-SOCKET-VERO13-18 Bender Wirth: 433 Typ L1</p>		
<p>OSRAM Opto Semiconductors</p> <p>LED Soleriq S9 FWHM 24.0° Efficiency 87 % Peak intensity 2.900 cd/lm LEDs/each optic 1 Light colour White Required components: C13083_PF-SOCKET C13333_MIRELLA-CL</p>		

PHOTOMETRIC DATA (SIMULATED):

OSRAM

Opto Semiconductors

LED Soleriq S9
 FWHM 24.0°
 Efficiency 86 %
 Peak intensity 2.900 cd/lm
 LEDs/each optic 1
 Light colour White
 Required components:
 C13083_PF-SOCKET
 C12479_MIRELLA-DL

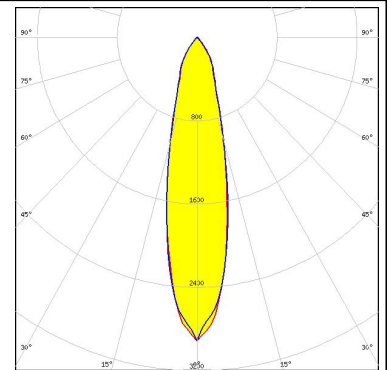

OSRAM

Opto Semiconductors

LED Soleriq S9
 FWHM 21.0°
 Efficiency 91 %
 Peak intensity 3.500 cd/lm
 LEDs/each optic 1
 Light colour White
 Required components:
 C13083_PF-SOCKET

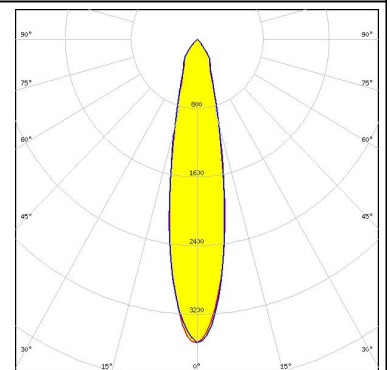

OSRAM

Opto Semiconductors

LED Soleriq S9
 FWHM 19.0°
 Efficiency 87 %
 Peak intensity 3.700 cd/lm
 LEDs/each optic 1
 Light colour White
 Required components:
 C13709_PF-SOCKET-VERO13-18
 Bender Wirth: 434 Typ L1

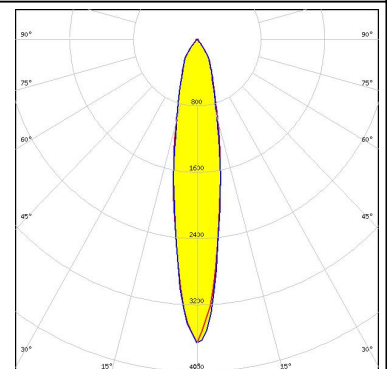

SAMSUNG

LED LC010C
 FWHM 16.0°
 Efficiency 87 %
 Peak intensity 4.800 cd/lm
 LEDs/each optic 1
 Light colour White
 Required components:
 C13709_PF-SOCKET-VERO13-18
 Bender Wirth: 479 Typ L1

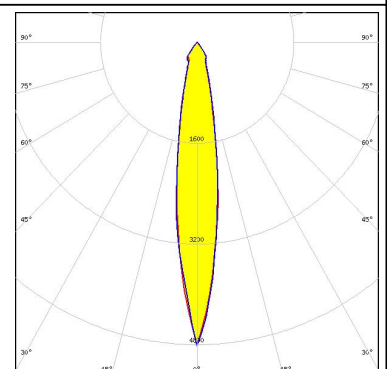

PHOTOMETRIC DATA (SIMULATED):

SAMSUNG

LED LC020C
FWHM 16.0°
Efficiency 86 %
Peak intensity 4.100 cd/lm
LEDs/each optic 1
Light colour White
Required components:
C13709_PF-SOCKET-VERO13-18
Bender Wirth: 479 Typ L1

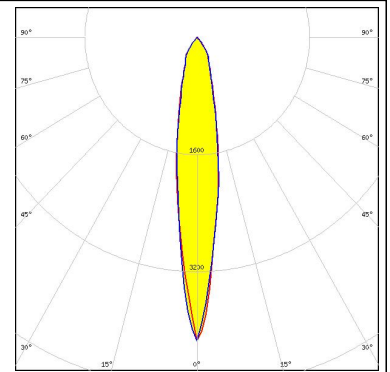

SAMSUNG

LED LC040C
FWHM 23.0°
Efficiency 84 %
Peak intensity 2.600 cd/lm
LEDs/each optic 1
Light colour White
Required components:
C13709_PF-SOCKET-VERO13-18
Bender Wirth: 480 Typ L1

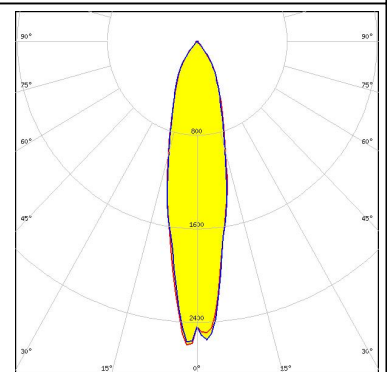

SEOUL SEMICONDUCTOR

LED ZC4/6
FWHM 21.0°
Efficiency 84 %
Peak intensity 3.100 cd/lm
LEDs/each optic 1
Light colour White
Required components:
C13709_PF-SOCKET-VERO13-18
Bender Wirth: 434 Typ L1



SEOUL SEMICONDUCTOR

LED ZC4/6
FWHM 20.0°
Efficiency 80 %
Peak intensity 3.100 cd/lm
LEDs/each optic 1
Light colour White
Required components:
C13709_PF-SOCKET-VERO13-18
C13333_MIRELLA-CL
Bender Wirth: 434 Typ L1

PHOTOMETRIC DATA (SIMULATED):

	
SEOUL SEMICONDUCTOR	
LED	ZC4/6
FWHM	27.0°
Efficiency	77 %
Peak intensity	2.000 cd/lm
LEDs/each optic	1
Light colour	White
Required components:	
C13709_PF-SOCKET-VERO13-18	
C12479_MIRELLA-DL	
Bender Wirth: 434 Typ L1	

GENERAL INFORMATION:

NOTE: The typical beam angle will be changed by different color, chip size and chip position tolerance. The typical total beam angle is the full angle measured where the luminous intensity is half of the peak value.

Due to use of high power COB's with this product, special attention to proper thermal design is highly recommended. LEDiL has no liability for direct, indirect or consecutive damages arising from the LEDiL products being used outside of the recommended temperature range.

MATERIALS:

As part of our continuous research and improvement processes, and to ensure the best possible quality and availability of our products, LEDiL reserves the right to change material grades without notice.

PRODUCT DATA USER AGREEMENT AND DISCLAIMER:

The measured data in the provided downloadable LEDiL Product Datasheets and Mechanical 2D-Drawings is rounded and provided as reference for planning. LEDiL Oy's optical specifications have been verified by conducting performance testing of the products in accordance with the company's quality system. The reported data are averaged results of multiple measurements with typical variation. LEDiL Oy reserves the right to without prior notification make changes and improvements to its products.

LEDiL Oy assumes neither warranty, nor guarantee nor any other liability of any kind for the contents and correctness of the provided data. The provided data has been generated with highest diligence but the provided data may in reality not represent the complete possible variation range of all intrinsic parameters. Therefore, in certain cases a deviation from the provided data could occur.

LEDiL Oy reserves the right to undertake technical changes of its products without further notification which could lead to changes in the provided data. LEDiL Oy assumes no liability of any kind for the possible deviation from any provided data or any other damage resulting from the usage of the provided data.

The user agrees to this disclaimer and user agreement with the download or usage of the provided files.

LEDiL Oy

Joensuunkatu 13
FI-24240 SALO
Finland

LEDiL Inc.

228 West Page Street
Suite D
Sycamore IL 60178
USA

Local sales and technical support

www.ledil.com/where_to_buy

Shipping locations

Salo, Finland
Hong Kong, China

Distribution Partners

www.ledil.com/where_to_buy