

No.	Changes and/or Note No.	Date	Intr	No	Changes and/or Note No.	Date	Intr
-----	-------------------------	------	------	----	-------------------------	------	------

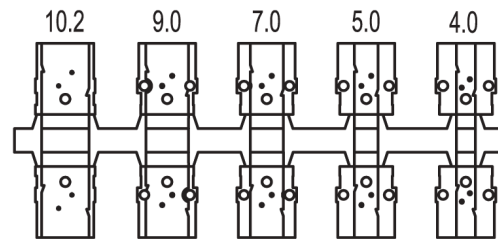
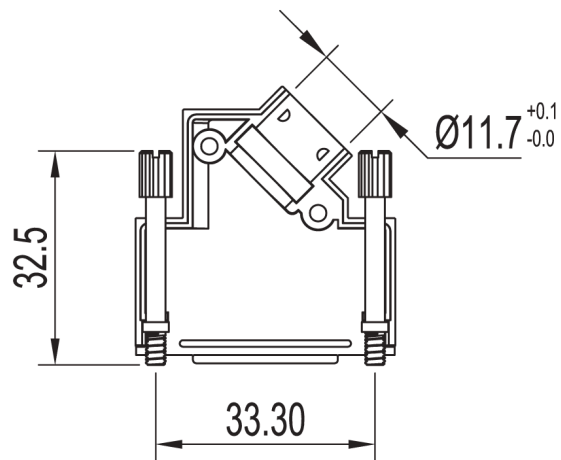
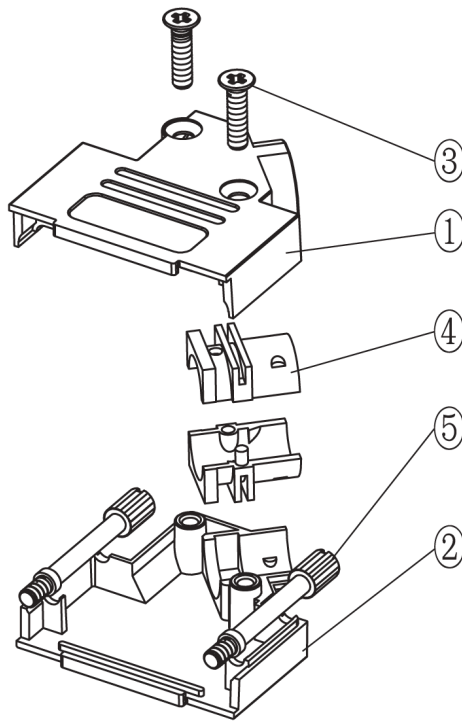
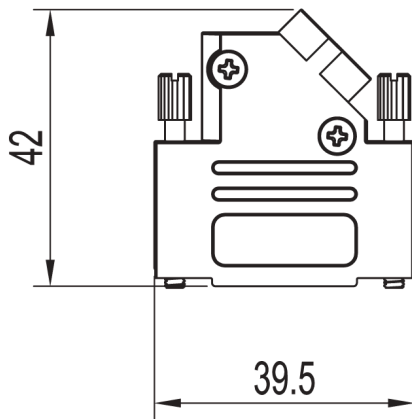

Grommet Set

Part Number:	Description:	Pack:	Item	QTY	Part description
6560-0116-12	D45ZK15-BK-K	Kit	1	1	D45ZK15-Upper cover
			2	1	D45ZK15-Lower cover
			3	2	M3X12 Countersunk screw
6561-0116-12	D45ZK15-BK	Bulk	4	1	D45ZK-D2 Grommet set
			5	2	UNC 4-40X32.5 Jackscrew

DATE: 2011-04-10	DRAWN: MRR	SCALE:	MATERIAL TYPE:	GENERAL TOLERANCES UNLESS OTHERWISE STATED LINEAR 0 ±0.20 0.0 ±0.15 0.00 ±0.10 ANGULAR ±0°30' ALL DIMENSIONS IN mm THIRD ANGLE PROJECTION
	APPROVED:		REPLACES:	

	D45ZK-BK-SERIES		DRAWING No: 6688-9556-BK