

Evaluation System for Stepping Motor with Resolver

R12UZ0065EJ0120

Rev.1.20

2022.2.21

User's Manual

Safety Precautions

Be sure to read this manual before using the Evaluation System for Stepping Motor with Resolver (RTK0EMX270S01020BJ) (Called "this product" below).

- Follow the instructions in this manual when using this product.
- Keep this manual near this product so you can refer to it whenever necessary.
- Transfer or sale of this product to third parties is prohibited without written approval.
- The purchaser or importer of this product shall ensure compliance with local regulations. In addition, the customer is responsible for ensuring that this product is handled correctly and safely, in accordance with the laws of the customer's country (region).
- The manuals and specifications related to this product (called "the documents, etc." below) are tools that were developed for the function and performance evaluation of Renesas Electronics semiconductor devices (called "Renesas Electronics devices" below) mounted on this product and do not guarantee the quality, function, and performance equivalent to Renesas Electronics products.
- By purchasing this product or downloading the documents, etc. from Renesas Electronics website, the support services provided from Renesas Electronics are not guaranteed.
- All information contained in this manual represents information on products at the time of publication of this manual. Note that the product data, specifications, contact for inquiries, contents of website, address, etc., are subject to change by Renesas Electronics Corporation without notice. Confirm the latest information on Renesas Electronics website, etc.

Meaning of Notations

In this manual, items related to the safe use of the product are indicated as described below.

■ The degree of injury to persons or damage to property that could result if the designated instruction in this manual is not followed is indicated as follows.

Danger	Indicates a thing that, if not followed, could result in death or serious injury(*1) to the user, and which is highly imminent.
Warning	Indicates a thing that, if not followed, could result in death or serious injury to the user.
Caution	Indicates a thing that, if not followed, could result in injury(*2) to persons or physical damage(*3).

*1 Serious injury refers to conditions resulting in persistent after-effects and for which treatment would necessitate hospitalization or regular hospital visits, such as loss of eyesight, burns (high- or low-temperature), electric shock, bone fracture, poisoning, or other injuries.

*2 Injury refers to conditions for which treatment would necessitate hospitalization or regular hospital visits.

*3 Physical damage refers to damage affecting the wider surroundings, such as the user's home or property.

■ Requirements related to the handling of the product are classified into the following categories.



• Marks indicating that an action is prohibited

	General prohibition The indicated action is prohibited.		(Example) Do not touch. Touching the specified location could result in injury.
---	--	---	--

• Marks indicating that an action requires caution.





	General caution Indicates a general need for caution that is not specified.		(Example) High temperature Indicates the possibility of injury due to high temperature.
---	--	---	--

• Marks directing that the specified action is required









	General instruction The specified action is required.		(Example) Turn off (disconnect) power. Instructs the user to turn off (disconnect) the power to the product.
---	--	---	---

Warnings Regarding Use of the Product





■ Danger Items

<h2 style="margin: 0;">Danger</h2>	
  	<ul style="list-style-type: none"> • The product should be used only by persons having a thorough knowledge of electrical and mechanical components and systems, a full knowledge of the risks associated with handling them, and training in inverter motor control and handling motors, or equivalent skills (called "users" below). Users should be limited to persons who have carefully read the Caution Items contained in this manual. • Unlike typical equipment, this product has no protective case to ensure safety, and it contains moving parts and high-temperature components that could be dangerous. Do not touch the evaluation board or cables while power is being supplied. • Carefully check to make sure that there are no pieces of conductive materials or dust adhering to the board, connectors, and cables. • There are moving parts, driven by a motor. Do not touch the motor while power is being supplied. • Ensure that the motor is insulated and placed in a stable location before supplying power.
	<p>Do not connect load to motor.</p> <ul style="list-style-type: none"> • This could cause fire, burns, or injury.

Warning Items

<h2>Warning</h2>	
	<p>Caution - Rotating parts</p> <ul style="list-style-type: none"> The system includes a motor. Touching the rotating shaft could cause high-temperature burns or injury.
	<p>Insert plugs, connectors, and cables securely, and confirm that they are fully inserted.</p> <ul style="list-style-type: none"> Incomplete connections could cause fire, burns, electric shock, or failures.
	<p>Use the power supply apparatus specified in the manual.</p> <ul style="list-style-type: none"> Failure to do so could cause fire, burns, electric shock, injury, or failures.
	<p>Stop supplying power and unplug all cables when the product will not be used for a period of time or when moving the product.</p> <ul style="list-style-type: none"> Failure to do so could cause heat, fire, burns, electric shock, or failures. This will protect the product against damage due to lightning.
	<p>Use a mechanism (switch, outlet, etc.) located within reach to turn off (disconnect) the power supply.</p> <ul style="list-style-type: none"> If an abnormality occurs, it may be necessary to cut off the power supply quickly.
	<p>Stop supplying power immediately if you notice abnormal odor, smoke, abnormal sound, or overheating.</p> <ul style="list-style-type: none"> Continuing to use the product in an abnormal condition could cause fire, burns, or electric shock.
	<p>Do not disassemble, modify, or repair the product.</p> <ul style="list-style-type: none"> Doing so could cause fire, burns, electric shock, injury, or failures.
	<p>Do not use this product for any purpose other than initial evaluation of motor control in a testing room or laboratory.</p> <p>Do not integrate the product or any part of it into other equipment.</p> <p>Do not insert or remove cables or connectors when the product is powered on.</p> <ul style="list-style-type: none"> The product has no safety case. Failure to observe the above could cause fire, electric shock, burns, or failures. The product may not perform as expected if used for other than its intended purpose.

Caution Items

<h2>Caution</h2>	
	<p>High temperature</p> <ul style="list-style-type: none"> The motor gets hot. Touching it could cause high-temperature burns.
	<p>Follow the procedure specified in the manual when turning the power to each system on or off.</p> <ul style="list-style-type: none"> Failure to do so could cause overheating or failures in devices.
	<p>Attention to static charge</p> <p>Before using this product, wear an antistatic wrist strap. If you touch this product with a static charge on your body, a device failure may occur or operation may become unstable.</p>
	<p>Before using this product, mount the ferrite core near this product on each cable for connecting this product and stabilized power supply.</p> <ul style="list-style-type: none"> Failure to do so could interfere with operation of other devices or cause failures in the devices.

Information Related to Regulations

European Union regulatory notices

This product complies with the following EU Directives. (These directives are only valid in the European Union.)

CE Certifications:

- Electromagnetic Compatibility (EMC) Directive 2014/30/EU
EN61326-1 : 2013 Class A

WARNING: This is a Class A product. This equipment can cause radio frequency noise when used in the residential area. In such cases, the user/operator of the equipment may be required to take appropriate countermeasures under his responsibility.

- Information for traceability
 - Authorised representative
Name: Renesas Electronics Corporation
Address: Toyosu Foresia, 3-2-24, Toyosu, Koto-ku, Tokyo 135-0061, Japan
 - Manufacturer
Name: Renesas Electronics Corporation
Address: Toyosu Foresia, 3-2-24, Toyosu, Koto-ku, Tokyo 135-0061, Japan
 - Person responsible for placing on the market
Name: Renesas Electronics Europe GmbH
Address: Arcadiastrasse 10, 40472 Dusseldorf, Germany
 - Trademark and Type name
Trademark: Renesas
Product name: Evaluation System for Stepping Motor with Resolver
Type name: RTK0EMX270S01020BJ

Environmental Compliance and Certifications:

- Waste Electrical and Electronic Equipment (WEEE) Directive 2012/19/EU

Overview of This Product

The Evaluation System for Stepping Motor with Resolver is a motor control evaluation kit.

This product has a resolver/digital converter IC manufactured by Renesas Electronics, which enables high resolution position control in combination with the motor with a resolver supplied with this product.

The product is equipped with various external device interfaces, which enables you to start the evaluation of the stepping motor with a resolver immediately by connecting a general motor control device.

In addition, this product supports the support tool for motor control development manufactured by Renesas Electronics (Renesas Motor Workbench). Renesas Motor Workbench can display internal variables of a microcontroller in waveform in real time and automatically extract vector control parameters, which enables efficient software development.

This user's manual describes how to handle this product. On this product, the connectors other than those required for quick start are not basically mounted at the factory. To use an interface described in this user's manual, it may be necessary to mount a required connector.

Mounted devices

Microcontroller:	R5F524TEADFP
Resolver/digital converter:	RAA3064002GFP
Gate driver:	HIP4082IBZ
RS-485 driver:	ISL3156EIUZ
CAN driver:	R2A25416SP
MOSFET:	RJK1054DPB
Regulator:	ISL9001AIRNZ, ISL9005AIRNZ

Related documents

- Related to 48V 2A inverter board for stepping motor
 - Circuit diagram: R12TU0083
 - Parts list: R12TU0085
 - PCB pattern diagram: R12TU0087
- Related to RX24T CPU card with RDC-IC
 - Circuit diagram: R12TU0082
 - Parts list: R12TU0084
 - PCB pattern diagram: R12TU0086
- Related to the support tool for motor control development "Renesas Motor Workbench"
 - User's Manual: R21UZ0004
- Sample code
 - Application note: R03AN0014

Included items

Refer to the "Included Items" supplied with this product.

Abbreviations

Abbreviation	Formal name	Remarks
this product	Evaluation System for Stepping Motor with Resolver	Model name: RTK0EMX270S01020BJ
inverter board	48V 2A inverter board for stepping motor	Model name: RTK0EM0000B11020BJ
CPU card	RX24T CPU card with RDC-IC	Model name: RTK0EMX270C02000BJ
RMW	Support tool for motor control development "Renesas Motor Workbench"	Support tool for motor control development manufactured by Renesas Electronics
MCU	microcontroller	Microcontroller mounted on this product (Model name: R5F524TEADFP)
RDC IC	resolver/digital converter IC	Resolver/digital converter IC mounted on this product (Model name: RAA3064002GFP)

Contents

Safety Precautions.....	1
Information Related to Regulations.....	4
Overview of This Product.....	5
1. Overview of the Product.....	8
1.1 Specifications.....	8
1.2 Block Diagram.....	9
1.3 Layout.....	10
2. Using This Product.....	11
2.1 Quick Start 1 Connection and Board Operations.....	11
2.2 Quick Start 2 GUI Operations.....	15
2.3 Initial Software Specifications.....	23
2.4 Writing to Flash Memory.....	24
2.5 Troubleshooting.....	25
3. Kit Specifications.....	27
3.1 Specification List.....	27
3.2 Stepping Motor with Resolver.....	28
3.3 Power Supply.....	29
3.4 Inverter Circuit.....	30
3.5 Sensor Interfaces.....	34
3.6 External Device Interfaces.....	37
3.7 User Interfaces.....	44
3.8 Pin Assignments.....	46
4. How to Flash Program MCU.....	51
Website and Support.....	54
Revision History.....	55

1. Overview of the Product

1.1 Specifications

Table 1-1 Overview of Specifications

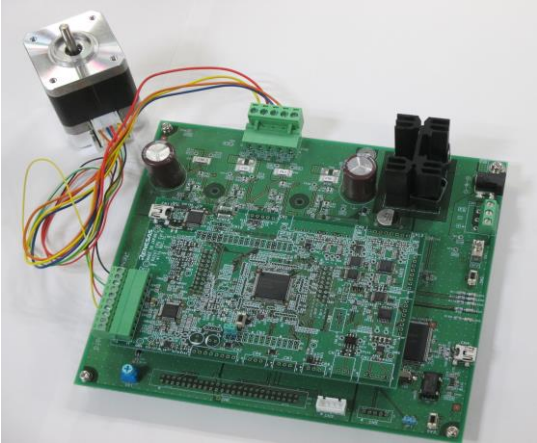
Item	Specification	
Kit name	Evaluation System for Stepping Motor with Resolver	
Kit model name	RTK0EMX270S01020BJ	
Kit configuration	48V 2A inverter board for stepping motor	RTK0EM0000B11020BJ
	RX24T CPU card with RDC-IC	RTK0EMX270C02000BJ
	Stepping motor with resolver	R17PMK440CNVA4438 (manufactured by MinebeaMitsumi Inc.) Rated current: 2 Apeak/Phase With a resolver
Inverter specifications	<ul style="list-style-type: none"> • Applicable motor: Stepping motor • Rated voltage: 48 V • Rated output: 100 W • Detection function: Phase current, bus voltage • Protection function: Overcurrent protection 	
Interface specifications	<ul style="list-style-type: none"> • Applicable sensors: Resolver, encoder(*1) • External device interfaces: RS-485(*1), CAN(*1), pulse train command(*1), general-purpose in/out(*1) 	
Development support functions	<ul style="list-style-type: none"> • Compatible with support tool for motor control development, Renesas Motor Workbench • With an on-board emulator circuit (flash programming circuit) 	
External view	 <p>Note: The actual product may differ from this photo.</p>	
Operating temperature	Room temperature	
Operating humidity	No condensation allowed.	
Compliance: EMC directive	Europe: EN61326-1: 2013 Class A	

*1 The connector is not mounted.

1.2 Block Diagram

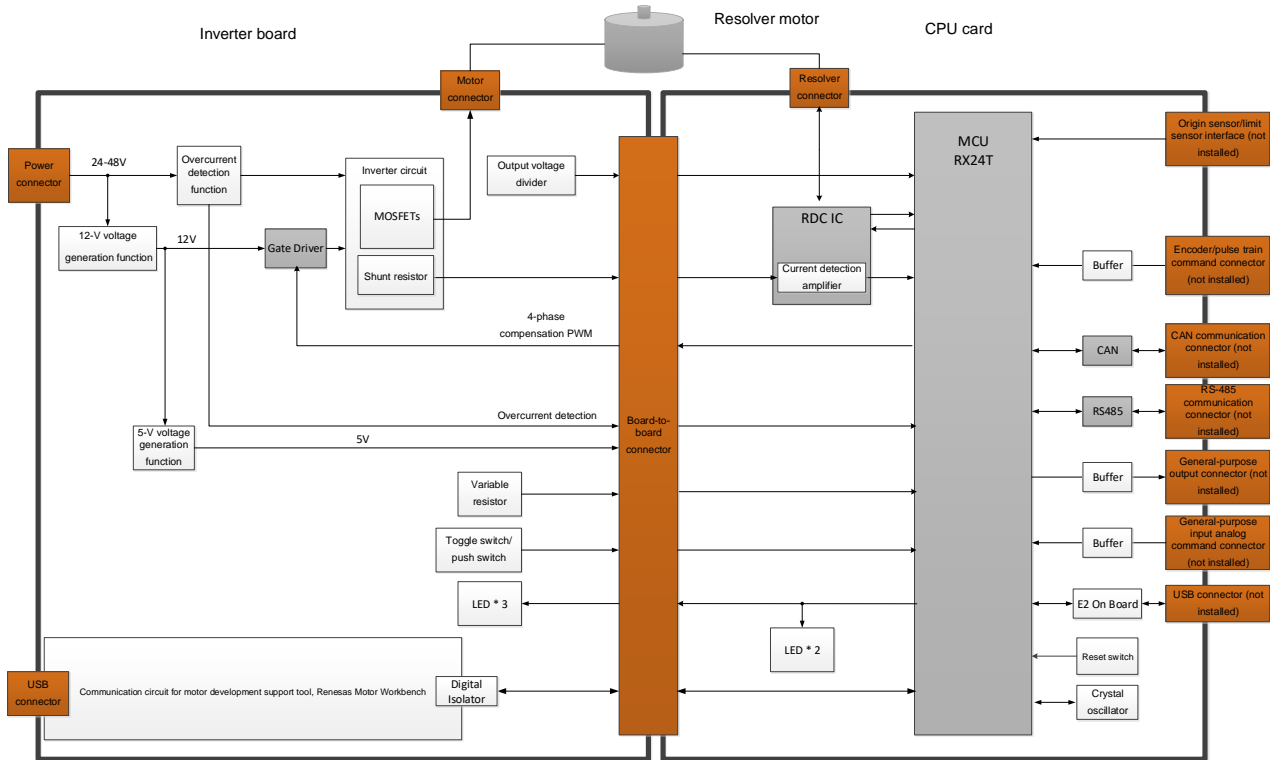

Figure 1-1 Block Diagram

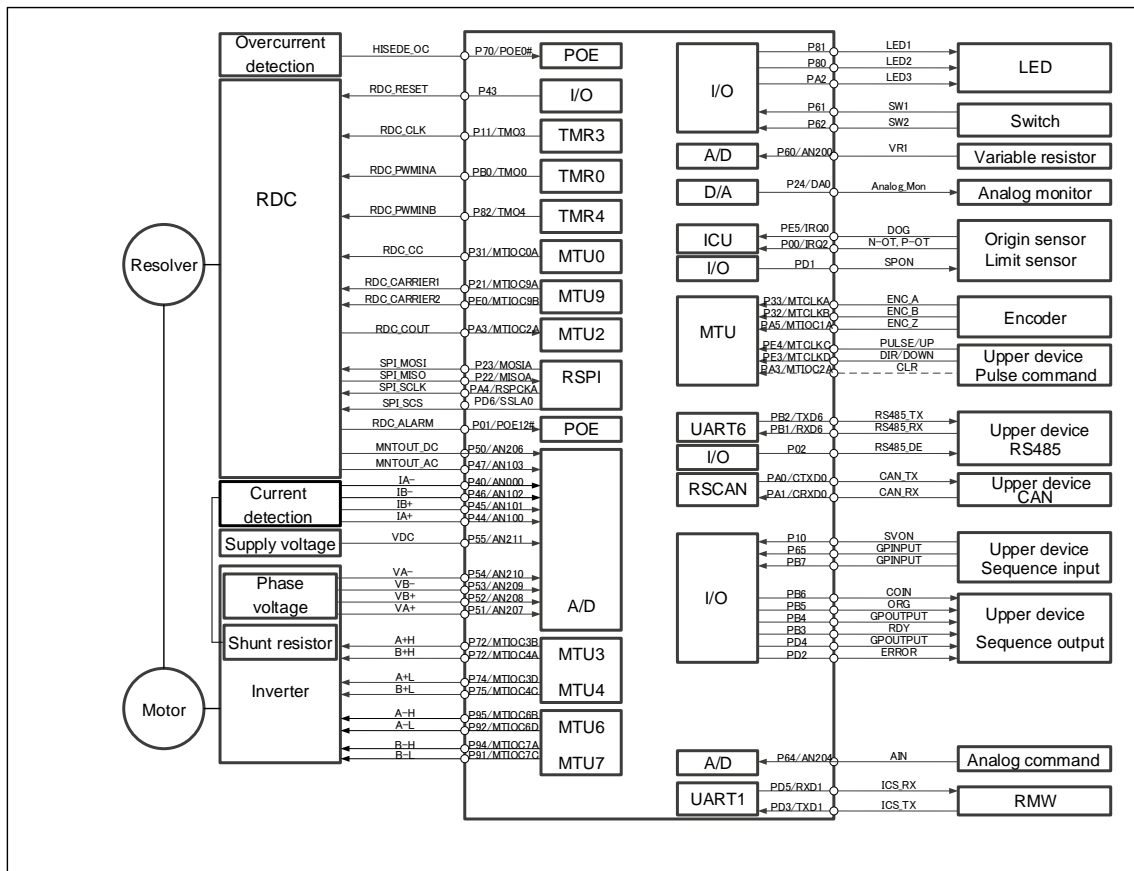

Figure 1-2 Connection Destinations of RX24T Pins by Function

1.3 Layout

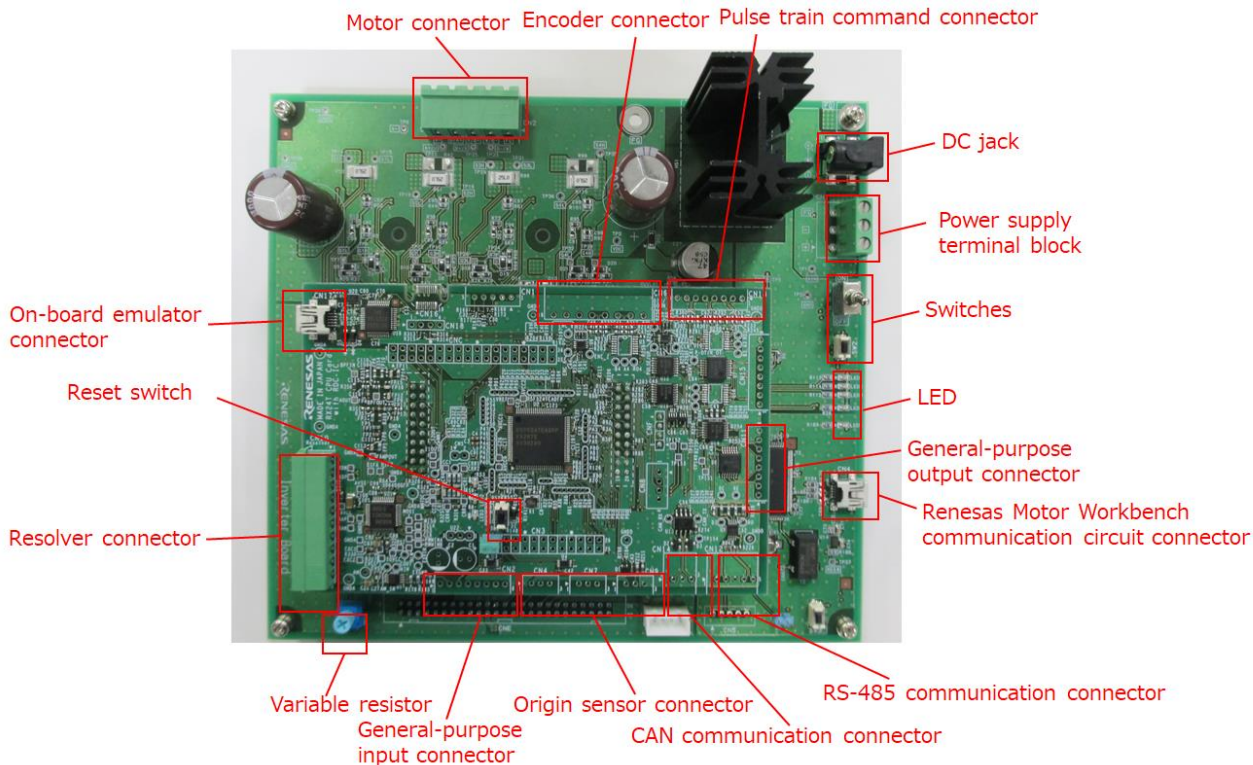

Figure 1-3 Layout

- * All connectors other than the resolver connector and on-board emulator connector are not mounted on the CPU card.
- * The actual product may differ from this photo.

2. Using This Product

2.1 Quick Start 1 Connection and Board Operations

This section describes a quick start procedure of this product. Perform steps (1) to (9) in this order.

A stepping motor with resolver (called a motor below) manufactured by MinebeaMitsumi Inc. is supplied with this product. Use the supplied motor in the procedure described in this section.

Before using this product, wear an antistatic wrist strap. If you touch this product with a static charge on your body, a device failure may occur or operation may become unstable.

Procedure of quick start 1

Step	Operation
(1)	Connecting the motor and board
(2)	Checking the variable resistor
(3)	Connecting the stabilized power supply and board
(4)	Supplying the power
(5)	Executing the calibration
(6)	Enabling the rotation of the motor
(7)	Checking that the motor speed changes
(8)	Stopping the rotation of the motor
(9)	Stopping supplying the power

Preparation

Prepare the following items.

- Stabilized power supply: 24 VDC or higher output voltage, 1 A or higher output current
- Two power cables: Cables through which 1 A or higher current can flow (for connecting the stabilized power supply and inverter board)

(1) Connecting the motor and board

First, connect the motor cable and the resolver cable to the supplied motor as shown in Figure 2-1. Then, connect the motor cable to the inverter board and the resolver cable to the CPU card as shown in Figure 2-2.

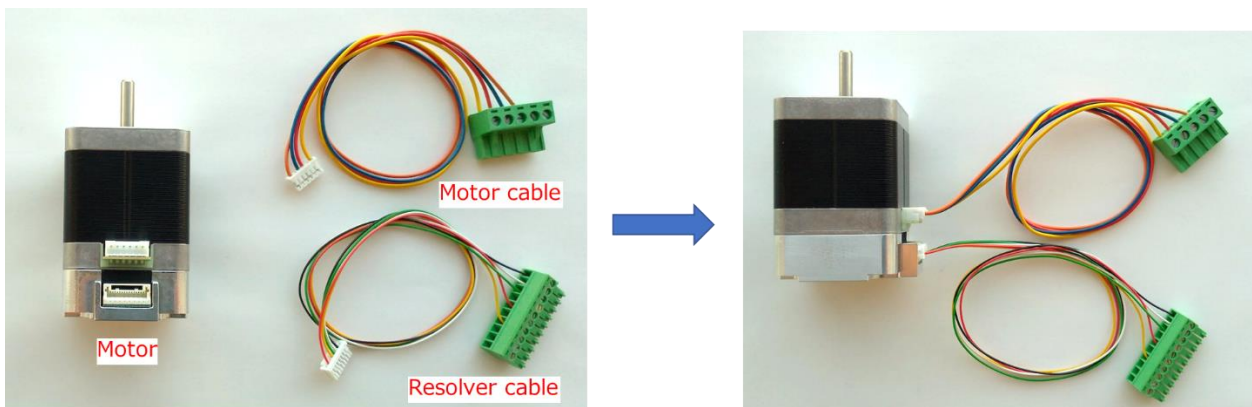

Figure 2-1 Connecting the Cables to the Motor

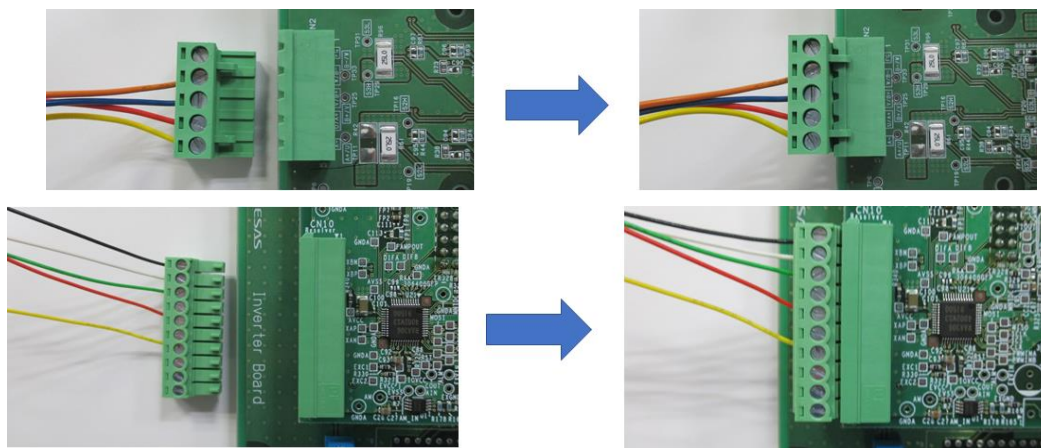

Figure 2-2 Connecting the Cables to the Boards

(2) Checking the SW1 and the variable resistor

While referencing Figure 2-3, check that the SW1 is OFF and the variable resistor (VR1) is in the center position. If the VR1 is not in the center position, adjust it in the center position with an ESD safe slotted screwdriver.

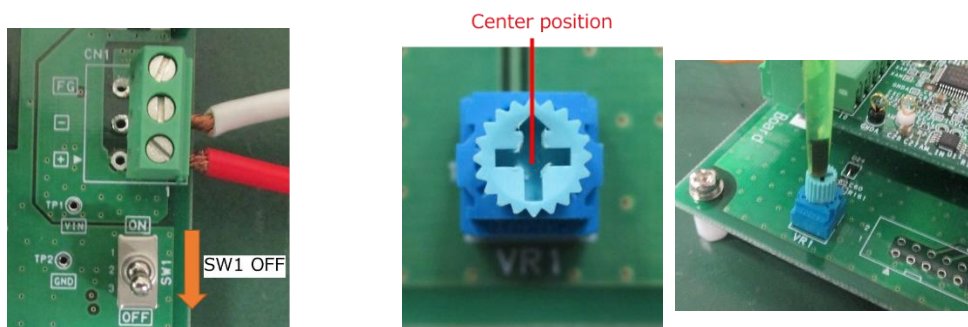

Figure 2-3 Checking the SW1 and the Variable Resistor

(3) Connecting the stabilized power supply and board

This product provides a terminal block and DC jack as connectors for supplying the power to the board. The following explains an example of connecting the board to the terminal block using a stabilized power supply. Connect the power supply to the board as shown in Figure 2-4.

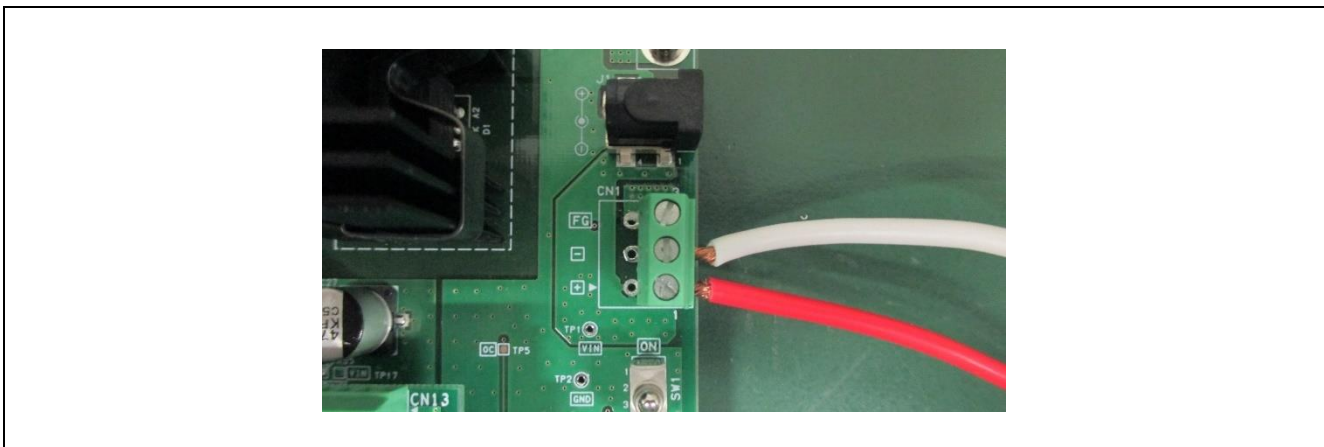

Figure 2-4 Power supply to the power connector

(4) Supplying the power

Use a stabilized power supply as the power supply, set the output voltage to 24 V and the limit current to 1 A, and start output. If the voltage drops even momentarily, a reset occurs since the voltage of the power supplied to the MCU also drops, which causes the program to be halted.

(5) Executing the calibration

For calibrating the motor parameters, push and release SW2 and wait for 30~40 seconds. The motor starts rotating in 20~30 seconds. It stops rotating when the calibration finishes.

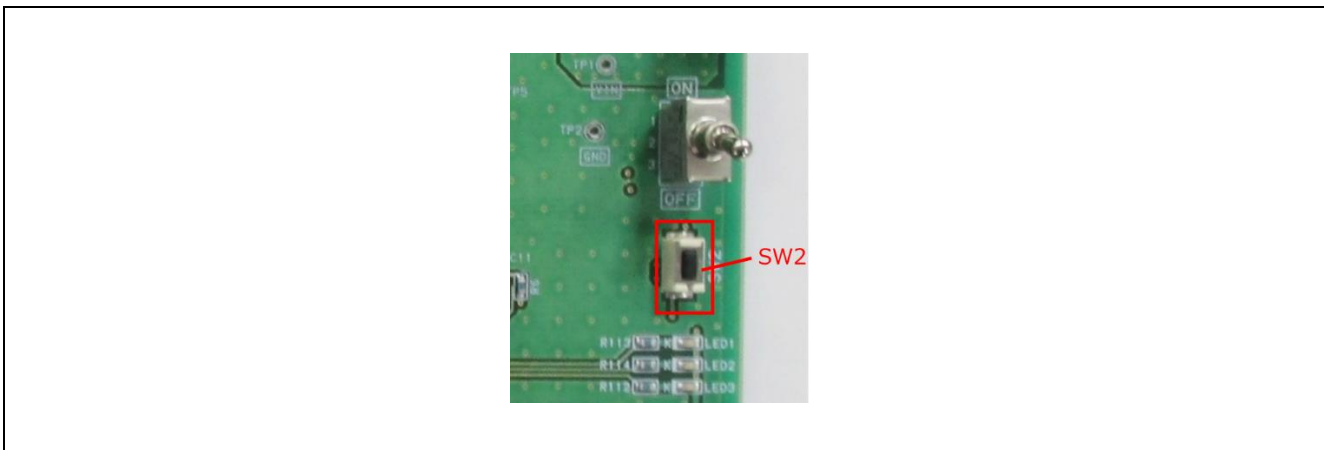

Figure 2-5 Push SW2 for the Calibration

(6) Enabling the rotation of the motor

To enable the rotation of the motor, turn the toggle switch (SW1) on as shown in Figure 2-6.

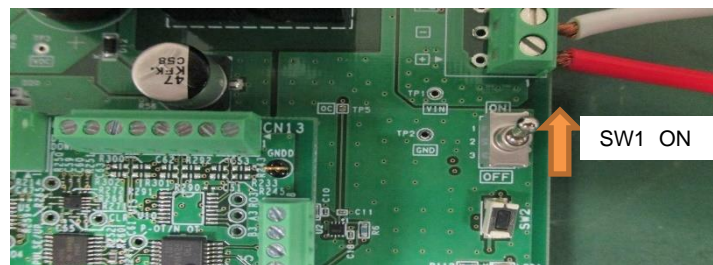

Figure 2-6 Enabling the Rotation of the Motor

(7) Checking that the motor speed changes

Check that the motor speed changes when you turn the rotor of the variable resistor (VR1).

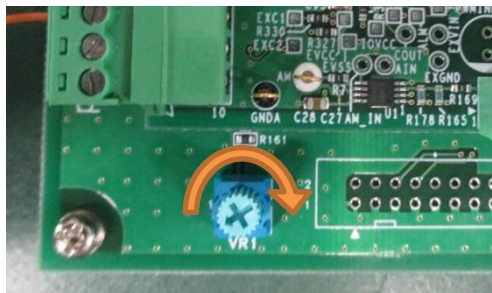

Figure 2-7 Changes of the Motor Speed

(8) Stopping the rotation of the motor

To stop the rotation of the motor, turn toggle switch SW1 off.

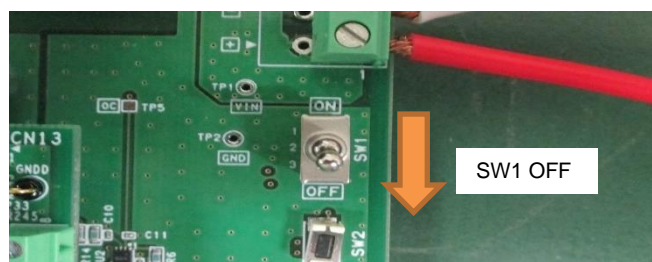

Figure 2-8 Stopping the Rotation of the Motor

(9) Stopping supplying the power

Check that the rotation stops and stop the output from the stabilized power supply.

2.2 Quick Start 2 GUI Operations

This section describes an operation procedure using Renesas Motor Workbench, support tool for motor control development which is an application running on a PC.

Before starting this operation procedure, make connections and confirm SW setting according to steps (1) to (3) in quick start 1. In addition, it is necessary to download the sample program “Vector Control of a Two-Phase Stepping Motor Incorporating a Resolver Sensor”(R03AN0014) from the product page and write the program to the CPU card according to the procedure described in Chapter 4.

Procedure of quick start 2

Step	Operation
(1)	Connecting a PC and this product
(2)	Connecting Renesas Motor Workbench
(3)	Loading the configuration file
(4)	Switching to the Analyzer tool
(5)	Changing the user interface
(6)	Executing offset calibration
(7)	Executing gain and phase calibration
(8)	Executing angle error calibration
(9)	Setting the command value of position control
(10)	Operating the motor in the position control mode
(11)	Turning the servo off
(12)	Sending a speed command
(13)	Stopping rotation
(14)	Stopping supplying the power

(1) Connecting a PC and this product

Connect the USB cable supplied with this product to the USB connector on a PC and USB connector CN4 on the inverter board. After that, turn the power to the board on as instructed in step (4) of quick start 1.

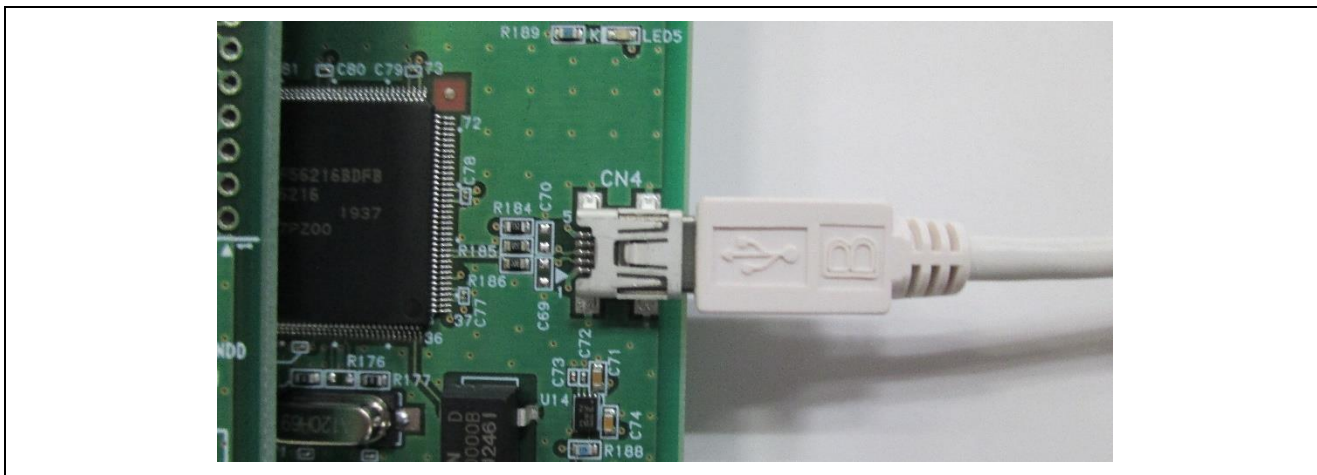

Figure 2-9 Connecting a PC

(2) Connecting Renesas Motor Workbench

Start up Renesas Motor Workbench and check that the relevant COM number is displayed.

For details of the methods of RMW operations described below, refer to "Support Tool for Motor Control Development, Renesas Motor Workbench User's Manual (R21UZ0004JJ)".

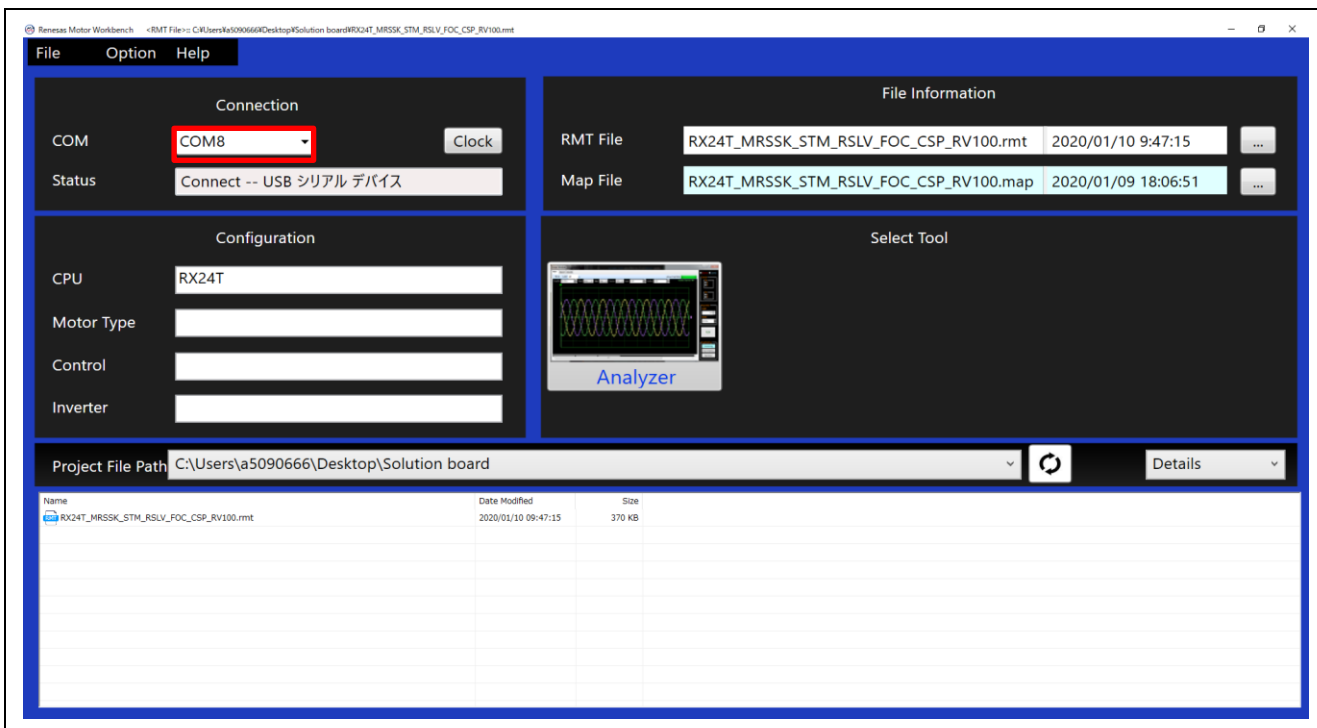

Figure 2-10 Checking the COM Number

(3) Loading the configuration file

Download the sample code “Vector Control of a Two-Phase Stepping Motor Incorporating a Resolver Sensor”(R03AN0014) and load the configuration file " RX24T_MRSSK_STM_RSLV_FOC_CSP_RVxxx.rmt " on Renesas Motor Workbench.

Note that the capture screens in this manual may be different from the actual ones.

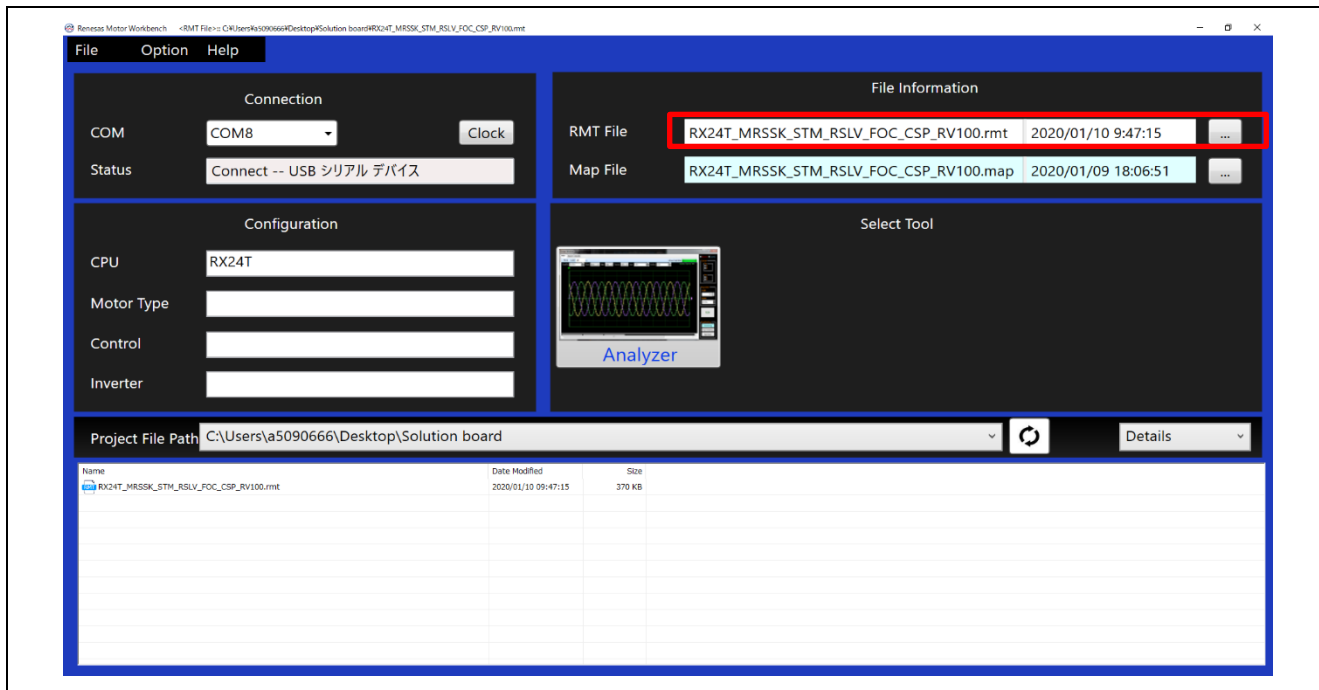

Figure 2-11 Reading the Configuration File

(4) Switching to the Analyzer tool

In the Main window, click the Analyzer button. Renesas Motor Workbench displays the windows for the Analyzer tool, Scope, User Button, and Control windows.

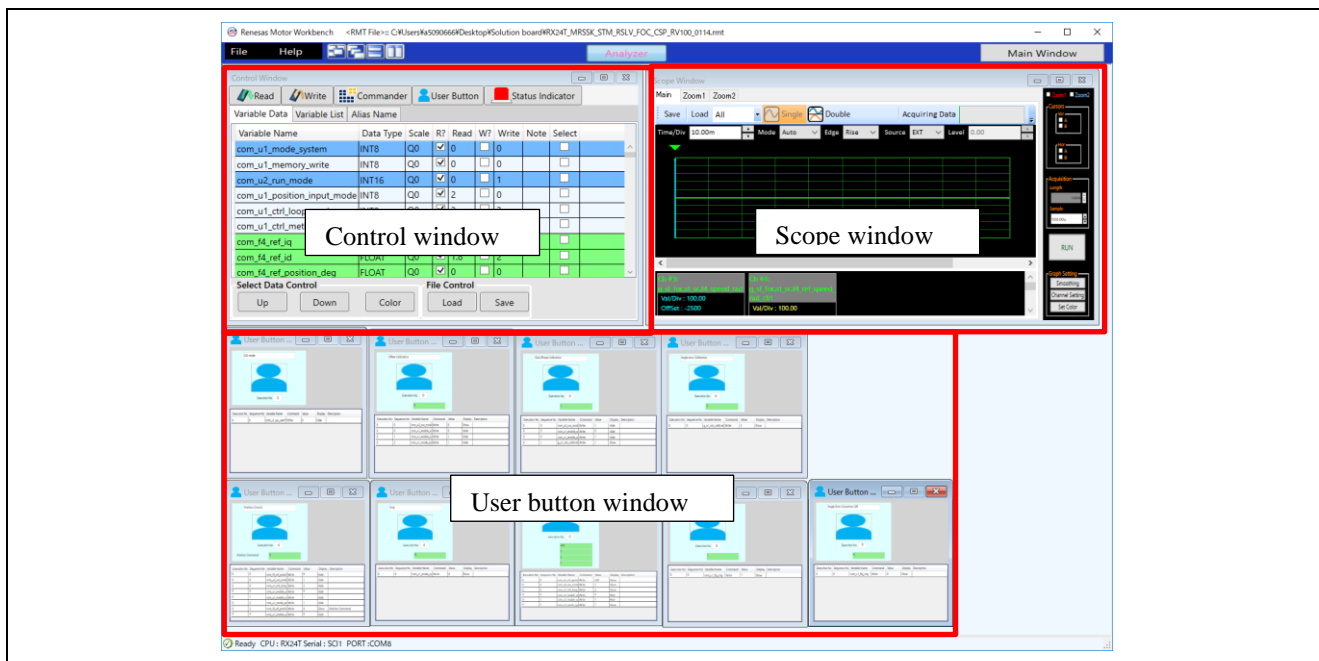

Figure 2-12 Display for the Renesas Motor Workbench Analyzer Tool

(5) Changing the user interface

Change the user interface from the switches and variable resistor on the board to Renesas Motor Workbench. On Renesas Motor Workbench, click the "GUI mode" User Button. Variable `com_u1_sw_userif` is rewritten from 1 to 0 and the interface changes.

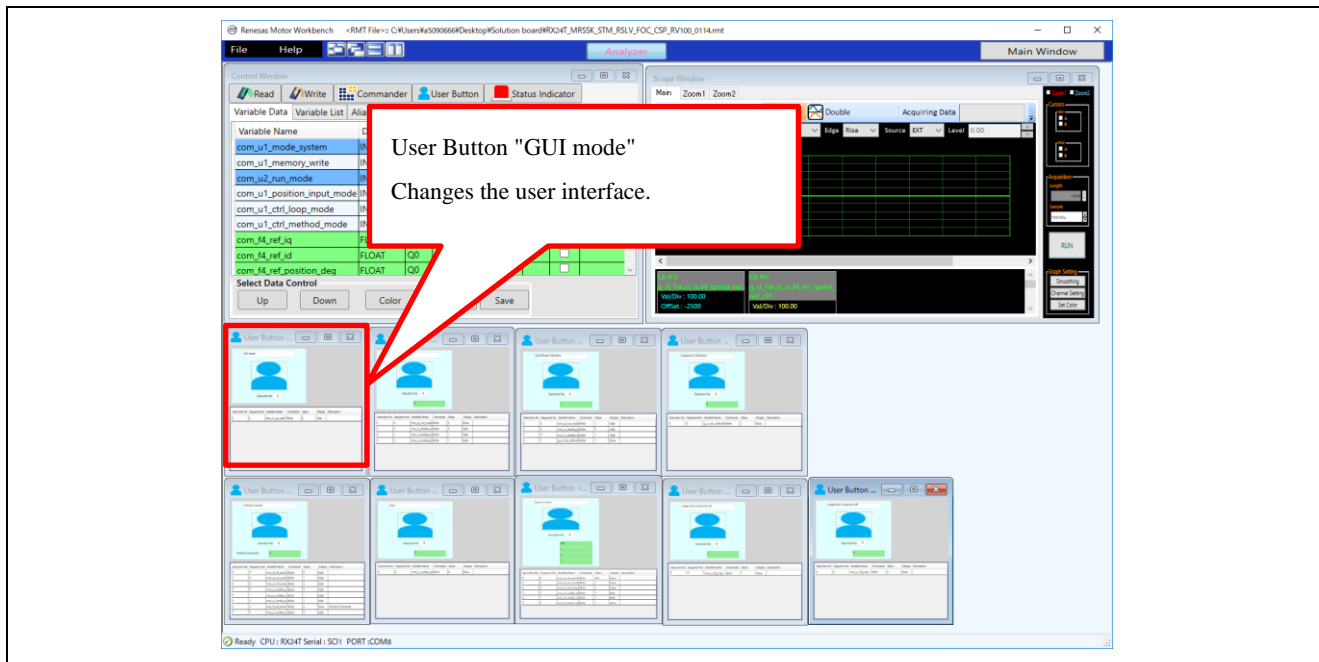

Figure 2-13 Changing the User Interface

(6) Executing offset calibration

Click the "Offset Calibration" User Button to execute offset calibration.

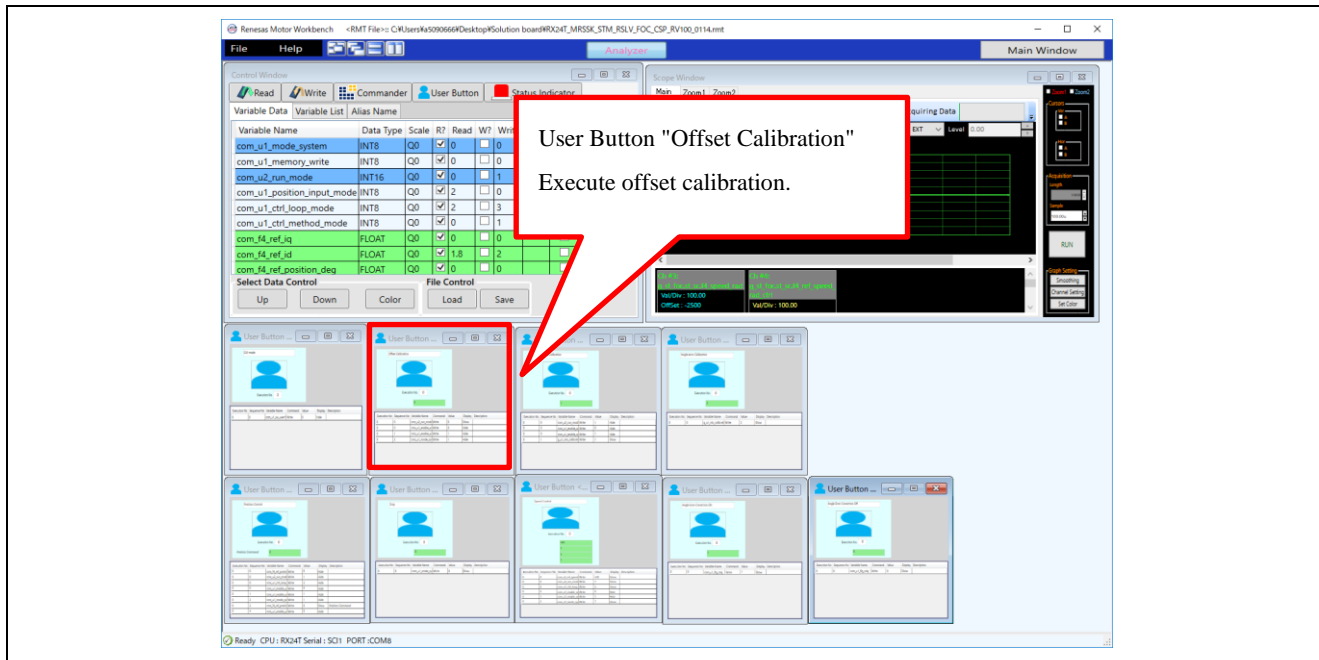

Figure 2-14 Starting the Execution of Offset Calibration

(7) Executing gain and phase calibration

Click the "Gain/Phase Calibration" User Button to execute gain and phase calibration.

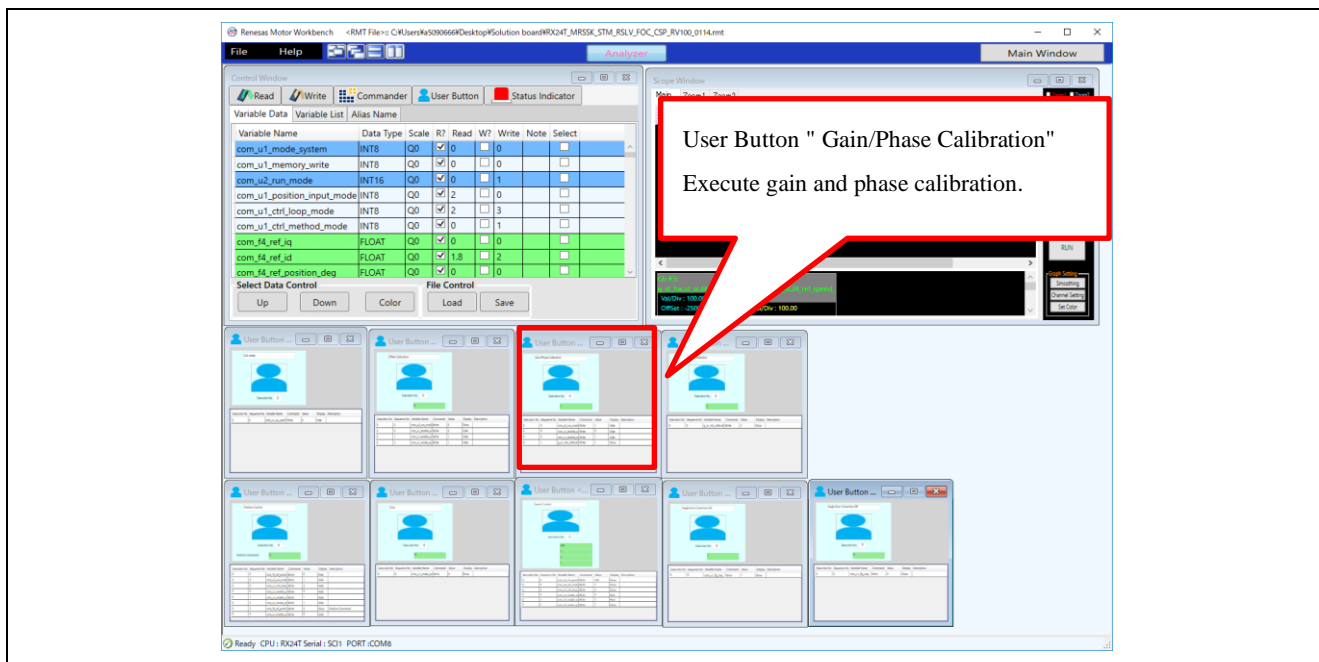

Figure 2-15 Starting the Execution of Gain/Phase Calibration

(8) Executing angle error calibration

Click the "Angle error Calibration" User Button to execute angle error calibration. The motor starts rotating in 20~30 seconds. It stops rotating when the calibration finishes.

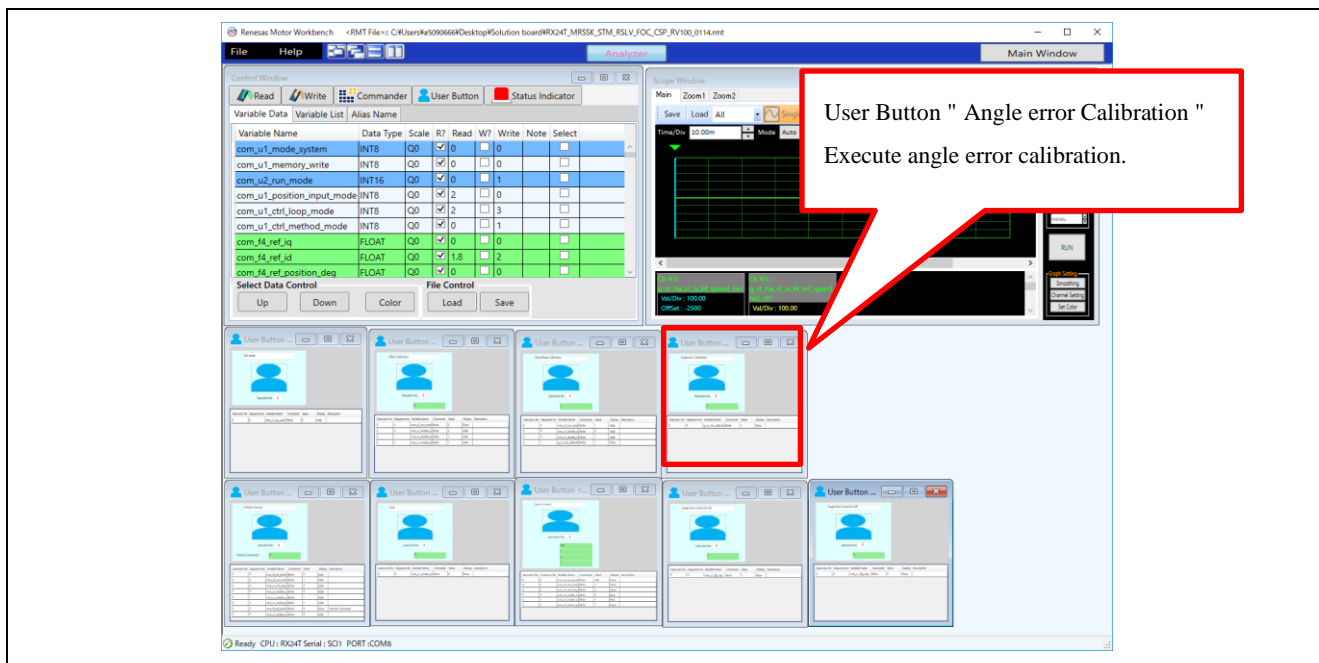

Figure 2-16 Starting the Execution of Angle Error Calibration

(9) Setting the command value of position control

Set the command value of position control in the "Position Control" User Button.

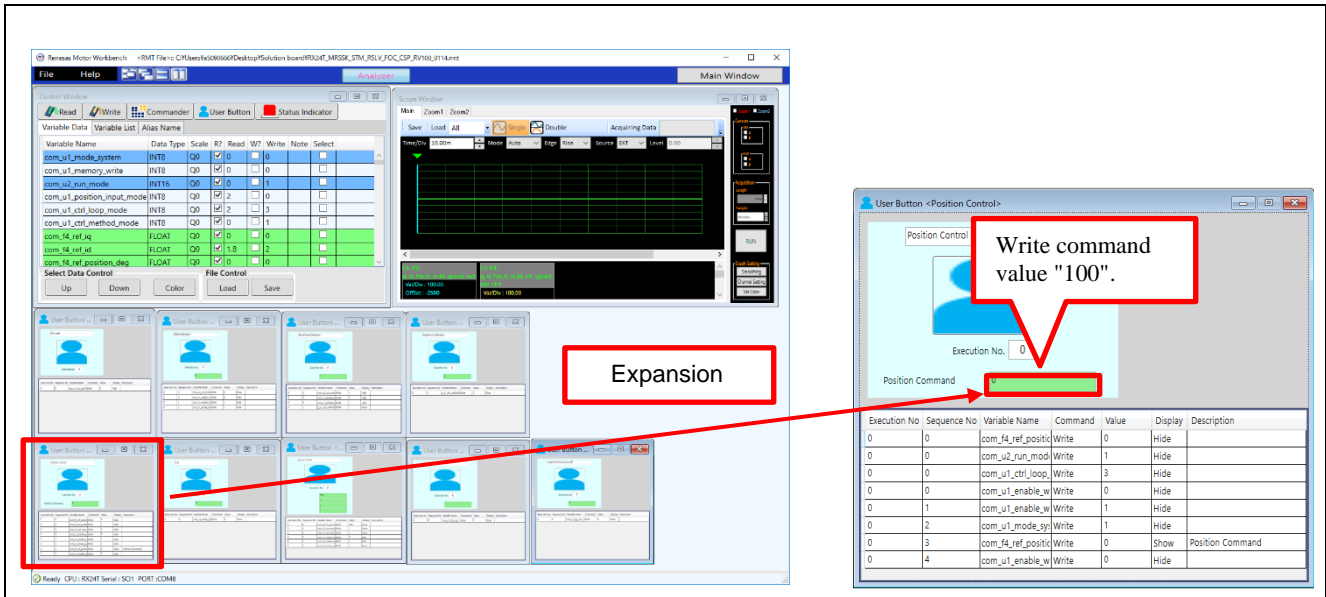

Figure 2-17 Write Command Value in the Position Control Mode

(10) Operating the motor in the position control mode

Click the "Position Control" User Button. The motor starts rotating and stops at the position set in the step (9).

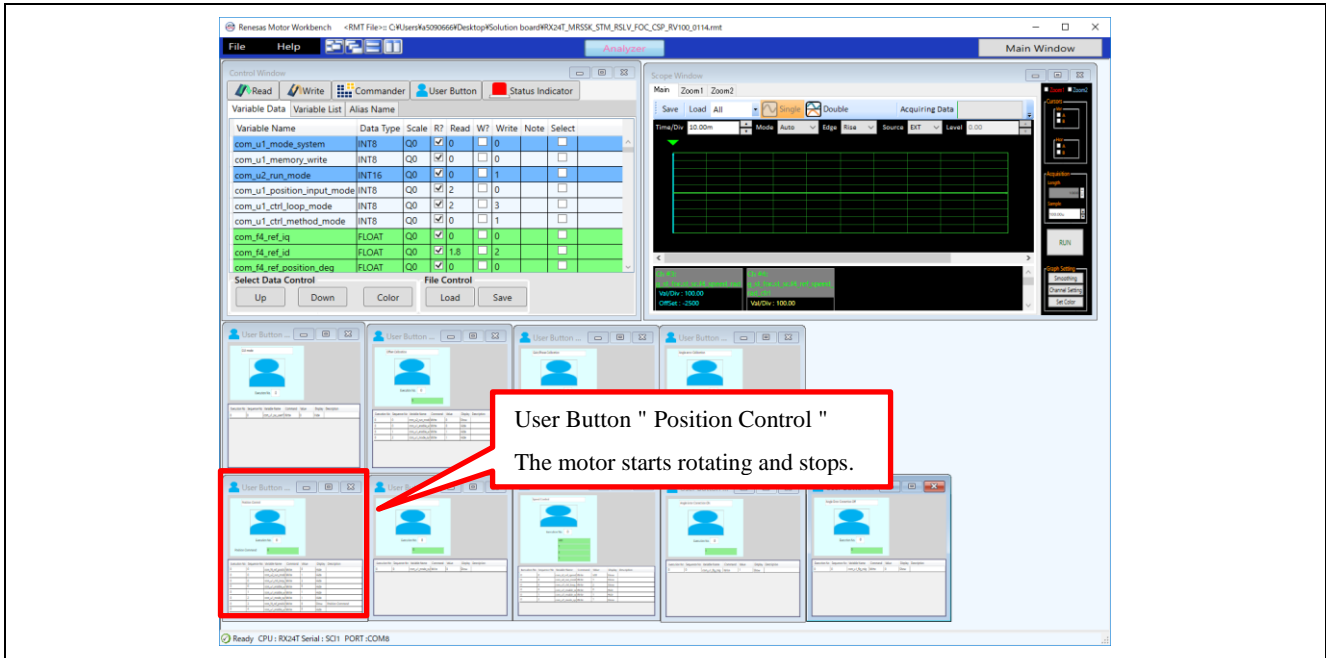

Figure 2-18 Position Control Mode

(11) Turning the servo off

Click the "Stop" User Button. The tool enters the stop mode from the position control mode and the servo is turned off. (The motor shaft is released.)

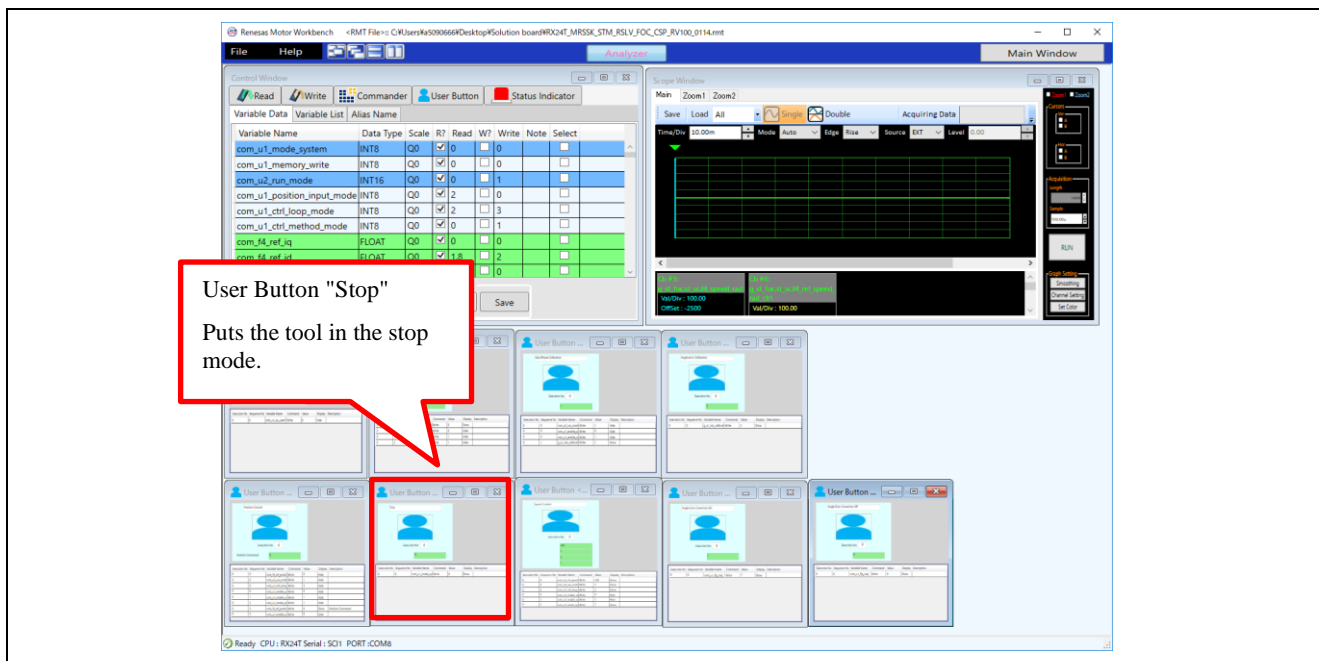

Figure 2-19 Turning the Servo Off

(12) Sending a speed command

Click the "Speed Control" User Button. The motor rotates in the speed control mode and a waveform is displayed in the Scope window.

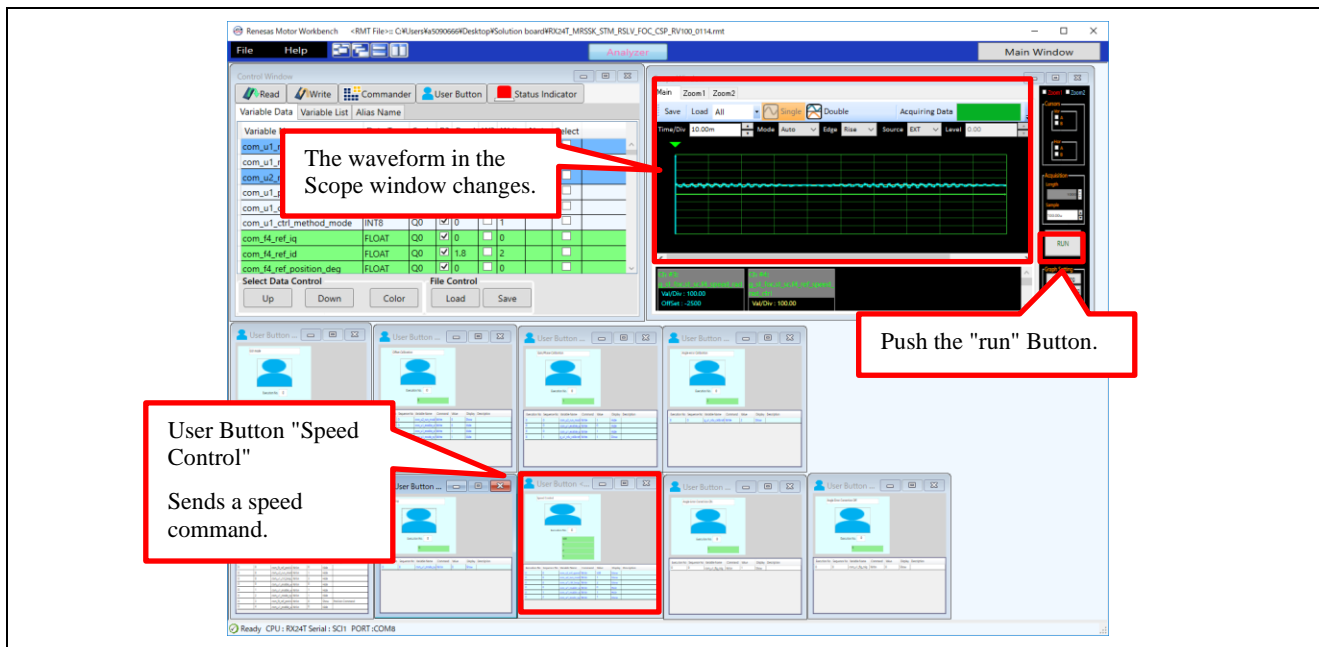

Figure 2-20 Setting a Speed Command

(13) Stopping rotation

Click the "Stop" User Button. The motor stops.

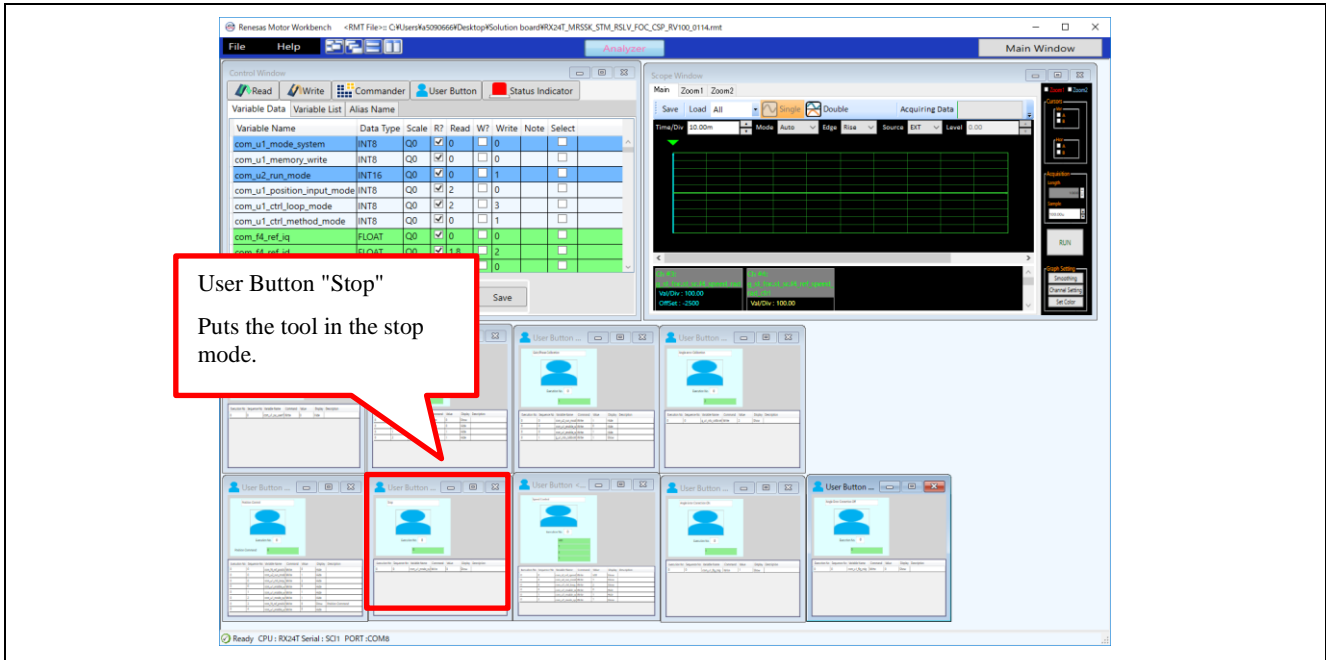

Figure 2-21 Stopping the Motor

(14) Stopping supplying the power

Check that the rotation stops and stop the output from the stabilized power supply.

2.3 Initial Software Specifications

Software for resolver vector control is factory-written on the RX24T. The specifications of the software are as follows.

Table 2-1 Initial Software Specifications

Item	Specification
Control method	Resolver vector control
VR1	Turned clockwise: Rotates the motor counterclockwise. Turned counterclockwise: Rotates the motor clockwise.
SW1	ON: Enables the rotation of the motor. OFF: Disables the rotation of the motor.
SW2	Error occurs : cancels the error status Motor rotates : N/A Motor stops : calibration
LED1	On: SW1 in the ON state and normal operating status Off: SW1 in the OFF state or error status
LED2	On: Error status Off: Normal operating status
Renesas Motor Workbench	Available

2.4 Writing to Flash Memory

Since this product has an on-board emulator circuit (flash programming circuit), you can write data to the flash memory without separately preparing a tool product. Connect the supplied USB cable to CN17 (USB mini-B connector) on the CPU card and the USB connector on the PC and write data using an application such as Renesas Flash Programmer or e²studio. With Renesas Flash Programmer and e²studio, the on-board emulator circuit is recognized as E2Lite. Make the connection setting for E2Lite.

For details of how to use each application, refer to the relevant user's manual.

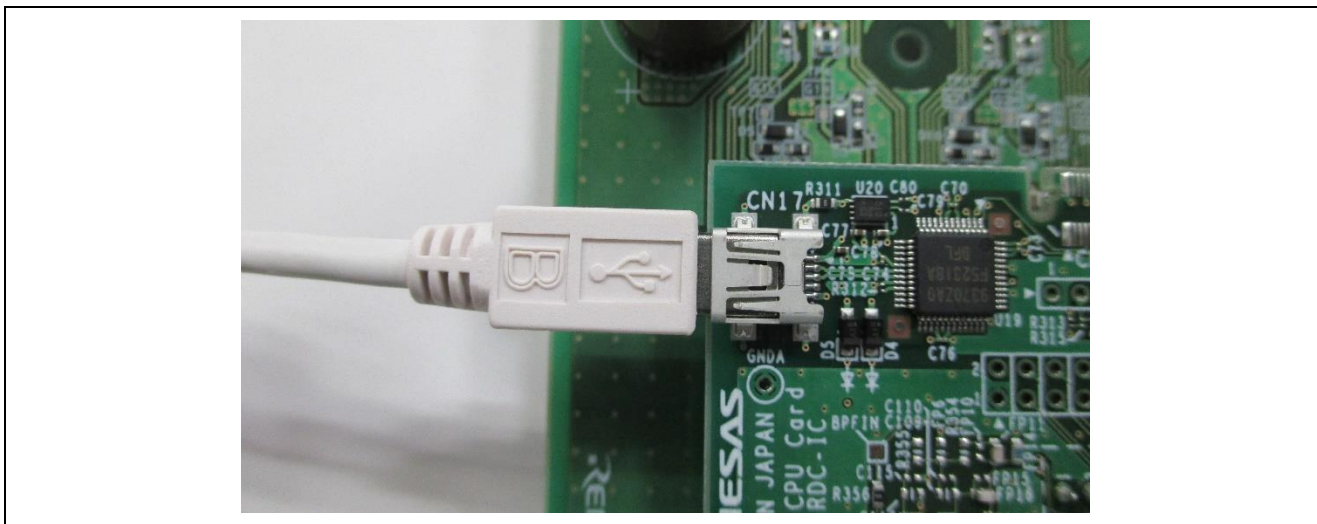

Figure 2-22 Connecting the Cable

2.5 Troubleshooting

- **A connector is not mounted.**

CN2, CN 4, CN 6, CN 7, CN 9, CN 11, CN 12, CN 13, and CN 14 are not mounted on the CPU card. Mount required connectors.

- **A cable is not connected (the number of connected cables is insufficient).**

In the normal status, four motor cables and five resolver cables are connected.

- **Some accessories are missing.**

Check the accessory list. If any accessory is missing, contact the supplier from which you purchased this product or Renesas Support.

- **The motor does not operate.**

Check whether power is supplied. Check whether the cable is connected.

- **The rotation speed is unstable.**

Execute auto calibration as instructed in quick start 2.

- **The motor stops (the error status occurs).**

Check whether the output current limitation of the power supply is proper. To rotate the supplied motor with no load, set the current limitation to 1 A or higher. Also, see 2.5.1 and 2.5.2.

- **This product cannot be connected with Renesas Motor Workbench (COM is not recognized).**

Check that the version of Renesas Motor Workbench is 2.0 or later. When multiple COM numbers are displayed, try to connect this product with another COM number.

- **This product cannot be connected with Renesas Motor Workbench (The MCU (RX24T) is not recognized).**

Check that the CPU card is correctly mounted on the inverter board and power is supplied to the inverter board. The power to the CPU card is supplied from the inverter board.

- **Software cannot be written to the MCU.**

Check that the write setting is correct (see 2.4).

- **Resetting this product to the factory settings**

You can find the factory-set software in the product website. Download and write the software.

2.5.1 When the Rotation of the Motor Stops

When the motor is driven, if any predetermined limit value is exceeded, the initial software assumes that an error occurred, turns LED2 on the inverter board and CPU card, and stops the rotation.

To recover from the error, press SW2 when the toggle switch SW1 is in the OFF position. When the error status is canceled, LED2 goes off.

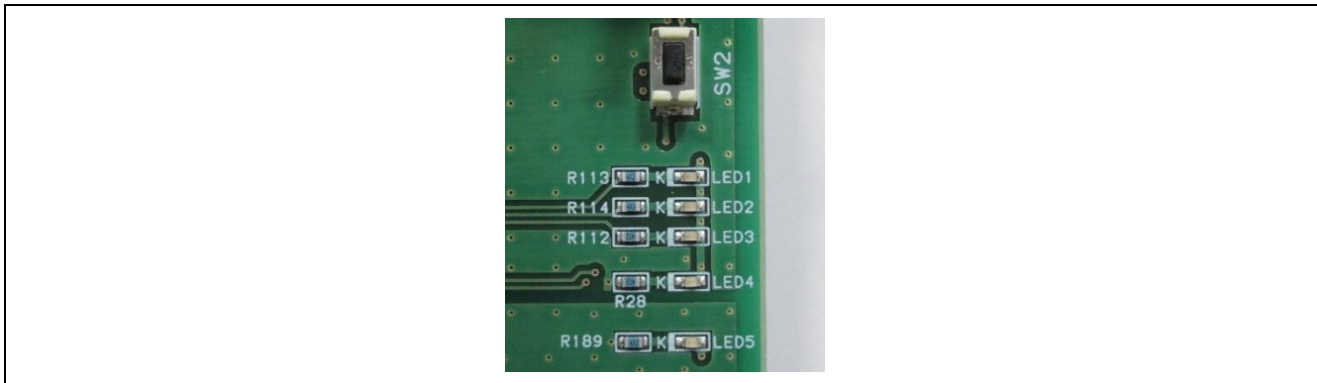

Figure 2-23 Error Notification LED and SW2

2.5.2 Checking the Status (Renesas Motor Workbench)

If LED2 is still on even after you perform the operation described in 2.5.1, you can possibly find the cause by checking the status with Renesas Motor Workbench. Click Read in the Control window of RMW to check the status.

The value of variable `_g_st_foc.u2_error_status`, which indicates the status may correspond to an error listed in Table 2-2.

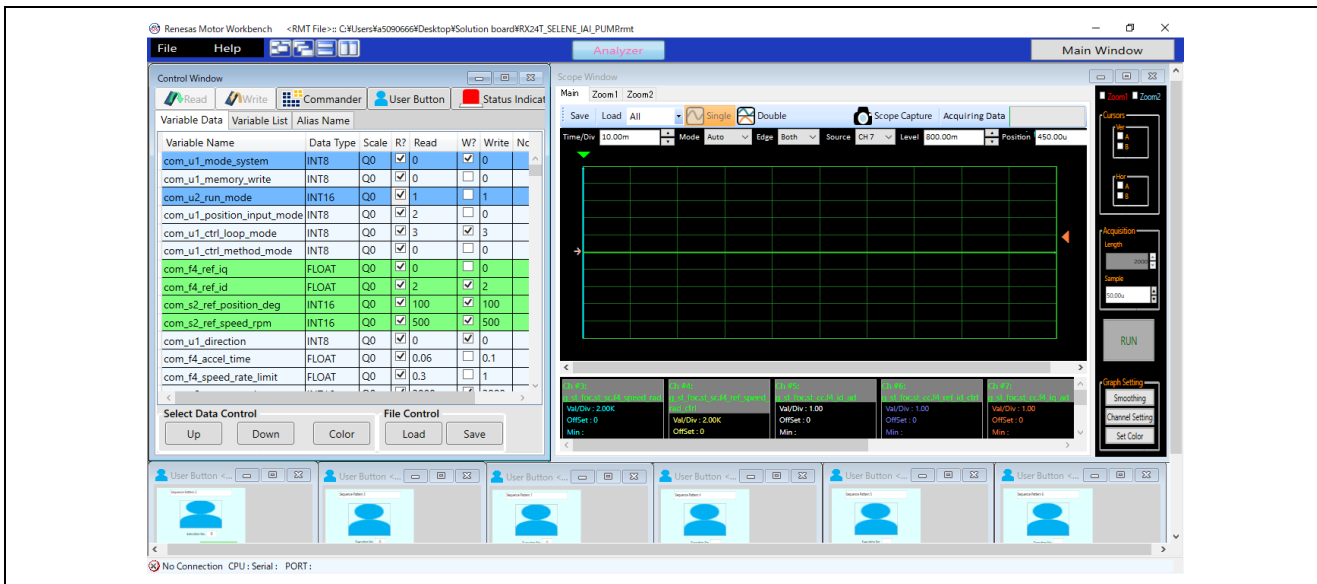

Figure 2-24 Checking the Status in the Control Window

Table 2-2 Values of the Variable and Corresponding Error Statuses

Variable <code>_g_st_foc.u2_error_status</code>	Error status
0x0001	Overcurrent
0x0002	Overvoltage

3. Kit Specifications

3.1 Specification List

Table 3-1 Specification List of the Evaluation System for Stepping Motor with Resolver

Major item	Item	Specification
MCU	Model name	R5F524TEADFP
	Operation clock	20-MHz crystal oscillator (PLL-multiplied internal frequency: 80 MHz)
Power supply	Input voltage	24 VDC (-5%) to 48 VDC (+5%)
	Connectors	<ul style="list-style-type: none"> • Terminal block • DC jack (PL03B, center-positive)
Supplied motor	Type	Stepping motor
	Size	42 mm square
	Rated current	2 A _{peak} /phase
	Holding torque	0.51 N m
Inverter circuit	Maximum output	100 W
	Switching frequency	20 kHz or lower
	Dead time	0.5 μs or longer *1
	PWM logic	Positive logic with both upper and lower arms
Current detection	Method	Voltage detection with a shunt resistor (-4 to +4 A)
	Current detection method	Phase current detection (phase A, phase B)
	Shunt resistor	25 mΩ
	Current detection amplifier gain	Bain: 20 Bias: 2.5 V
	A/D input range	0.25 to 4.75 V (A/D input pin with an independent sample-and-hold circuit)
Sensors	Resolver	Method: Single-phase excitation two-phase output Excitation frequency: 20 kHz
	Encoder	Open-collector output, 200 kp/s applicable
Voltage detection	DC bus voltage detection (Bus voltage detection)	Detection by resistance division $V_{DC} \times \frac{470}{10470}$
	Phase voltage detection	Detection by resistance $\text{phase - voltage} \times \frac{470}{10470}$
Protection circuit	Overcurrent detection	When the current is 5 A, the overcurrent detection signal is output and the inverter circuit stops*2.
	Fuse	Rated current: 8 A
	Reverse current prevention diode	Repetitive peak reverse voltage: 75 V or higher
External device interfaces	Communication interfaces	<ul style="list-style-type: none"> • Renesas Motor Workbench communication circuit • RS-485 communication circuit • CAN communication circuit
	Other interfaces	<ul style="list-style-type: none"> • Pulse train command input circuit • General-purpose input/output circuits
User interfaces	Input	<ul style="list-style-type: none"> • One toggle switch, one push switch • Variable resistor
	Display	<ul style="list-style-type: none"> • Three LEDs (Two of three are synchronized with LEDs on the CPU card.) • LED for the power supply of the inverter control circuit • LED for the power supply of the CPU card

*1 It is not the dead time guaranteed with hardware. A dead time must be set with software. The dead time in the initial program is factory-set to 0.5 μs.

*2 To stop the inverter circuit, the POE function of the MCU is used.

3.2 Stepping Motor with Resolver

Table 3-2 lists the specifications of the stepping motor with resolver in this product. Figure 3-1 shows the external view of the motor.

Table 3-2 Specifications of the Stepping Motor with Resolver

Model No.	R17PMK440CNVA4438
Rated current (Apeak/Phase)	2.0
Winding resistance (ohm)	1.2
Holding torque (Nm)	0.51
Inductance (mH)	2.6
Rotor inertia (kgm ²)	75.0
Detent torque (Nm)	0.017

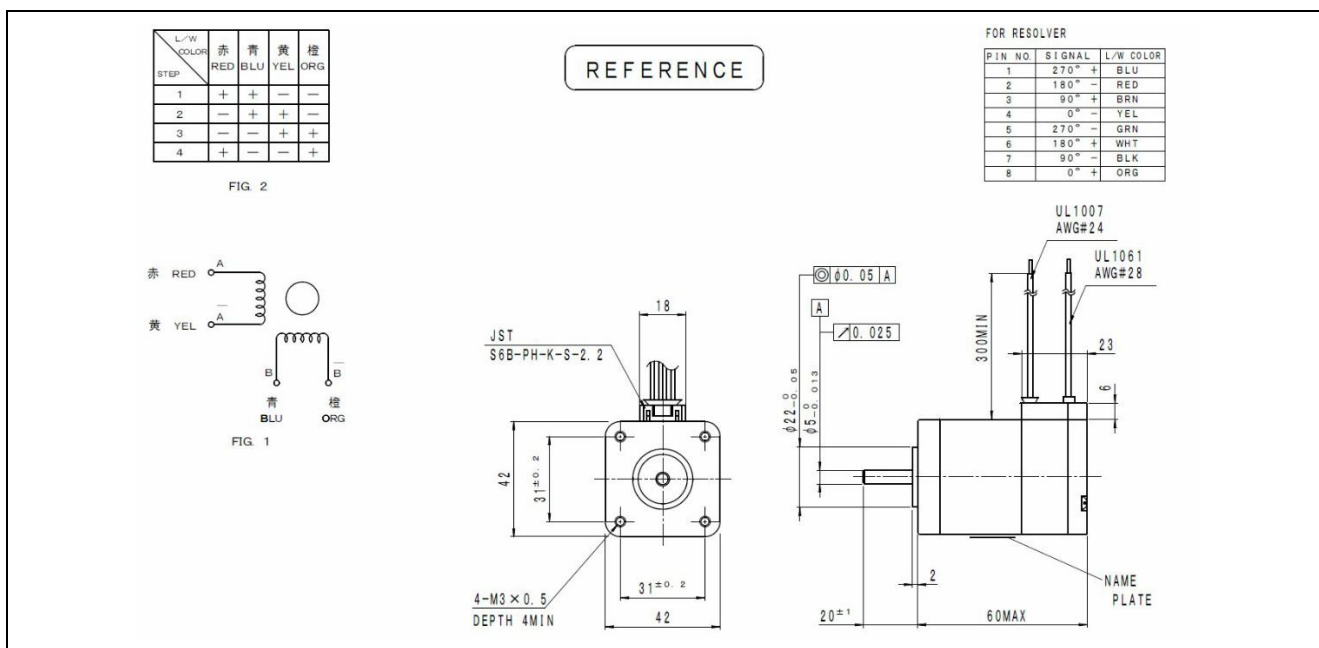

Figure 3-1 External View of the Stepping Motor with Resolver

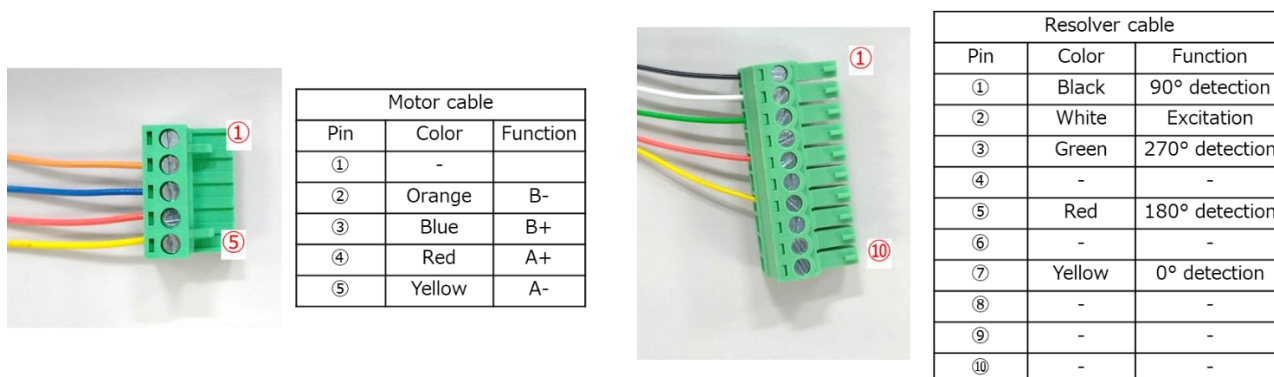

Figure 3-2 Motor and Resolver Cable Wiring

3.3 Power Supply

To operate this product, it is necessary to apply 24 to 48 VDC externally. As connectors, the following items are provided: Terminal block for connecting a stabilized power supply or switching power supply and a DC jack for connecting an AC adapter. A voltage of 12 V for the gate driver and a voltage of 5 V for the MCU and other ICs are generated on the inverter board.

A frame ground is provided on the terminal block. In addition, one of spacer mounting holes is connected to a frame ground. When it is necessary to connect a frame ground, use either of them.

Figure 3-3 shows the connector. Table 3-3 lists the power input specifications. Table 3-4 lists the pin assignments of the terminal block.

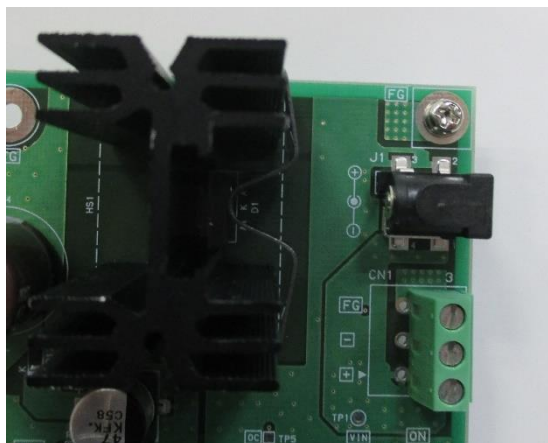

Figure 3-3 Power Connector

Table 3-3 Power Input Specifications

	Power supply terminal block	DC jack
Input voltage	24 to 48 V \pm 5%	24 V \pm 5%
Input current	5 A (max)	3.5 A (max)
Applicable cable	Cross section: 0.20 to 1.50 mm ² AWG: 16 to 30	Center-positive Center diameter: 2 Barrel diameter: 6.5

Table 3-4 Power Supply Terminal Block

Connector	Signal name	Description
Inverter board CN1.1	VIN	Positive power input
Inverter board CN1.2	GND	Reference power input
Inverter board CN1.3	FG	Frame ground

A protection circuit is provided at the power input section, which consists of an overcurrent detection circuit, overcurrent protection fuse, and reverse current prevention diode. The overcurrent detection circuit outputs the overcurrent detection signal when the input current reaches 5 A. The rated current of the fuse is 8 A. Table 3-5 lists the specifications of the protection circuit.

Table 3-5 Specifications of the Protection Circuit

Overcurrent detection threshold	5 A
Destinations of the overcurrent detection signal	CNA.5, U2 (P70/POE0#) on the CPU card
Fuse characteristics	Rated current: 8 A. Blown at twice the rated current within 5 seconds.

3.4 Inverter Circuit

This product has an inverter circuit for driving a 2-phase stepping motor and a connector for connecting the motor.

3.4.1 Connector

The plug of the connector for connecting the motor is separated from the socket. The connector is located at the position shown in Figure 3-4.

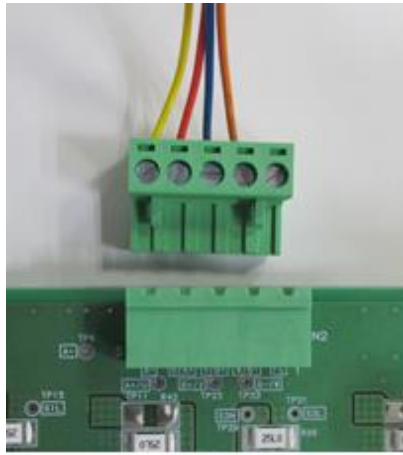

Figure 3-4 Connector for Connecting the Motor

3.4.2 Inverter, Gate Driver

As the gate driver, the HIP4082 manufactured by Renesas Electronics Corporation is used. As the MOSFET, the RJK1054DPB is used. Table 3-6 and Figure 3-5 show the configuration and connection of the inverter circuit.

Table 3-6 Inverter Drive Signal Board-to-Board Connection

CPU card	Board-to-board connector	Inverter board			
		Gate driver input	Gate driver output	MOSFET	Motor pin
U2.56 (P71/MTIOC3B)	CNA.12	U4.7 (AHI)	U4.10 (AHO)	Q3	CN2.4 (phase A+)
U2.53 (P74/MTIOC3D)	CNA.9	U4.4 (ALI)	U4.13 (ALO)	Q4	
U2.55 (P72/MTIOC4A)	CNA.11	U10.2 (BHI)	U10.16 (BHO)	Q5	CN2.3 (phase B+)
U2.52 (P75/MTIOC4C)	CNA.8	U10.3 (BLI)	U10.14 (BLO)	Q6	
U2.45 (P95/MTIOC6B)	CNA.6	U4.2 (BHI)	U4.16 (BHO)	Q1	CN2.5 (phase A-)
U2.48 (P92/MTIOC6D)	CNA.4	U4.3 (BLI)	U4.14 (BLO)	Q2	
U2.46 (P94/MTIOC7A)	CNA.10	U10.7 (AHI)	U10.10 (AHO)	Q7	CN2.2 (phase B-)
U2.49 (P91/MTIOC7C)	CNA.7	U10.4 (ALI)	U10.13 (ALO)	Q8	

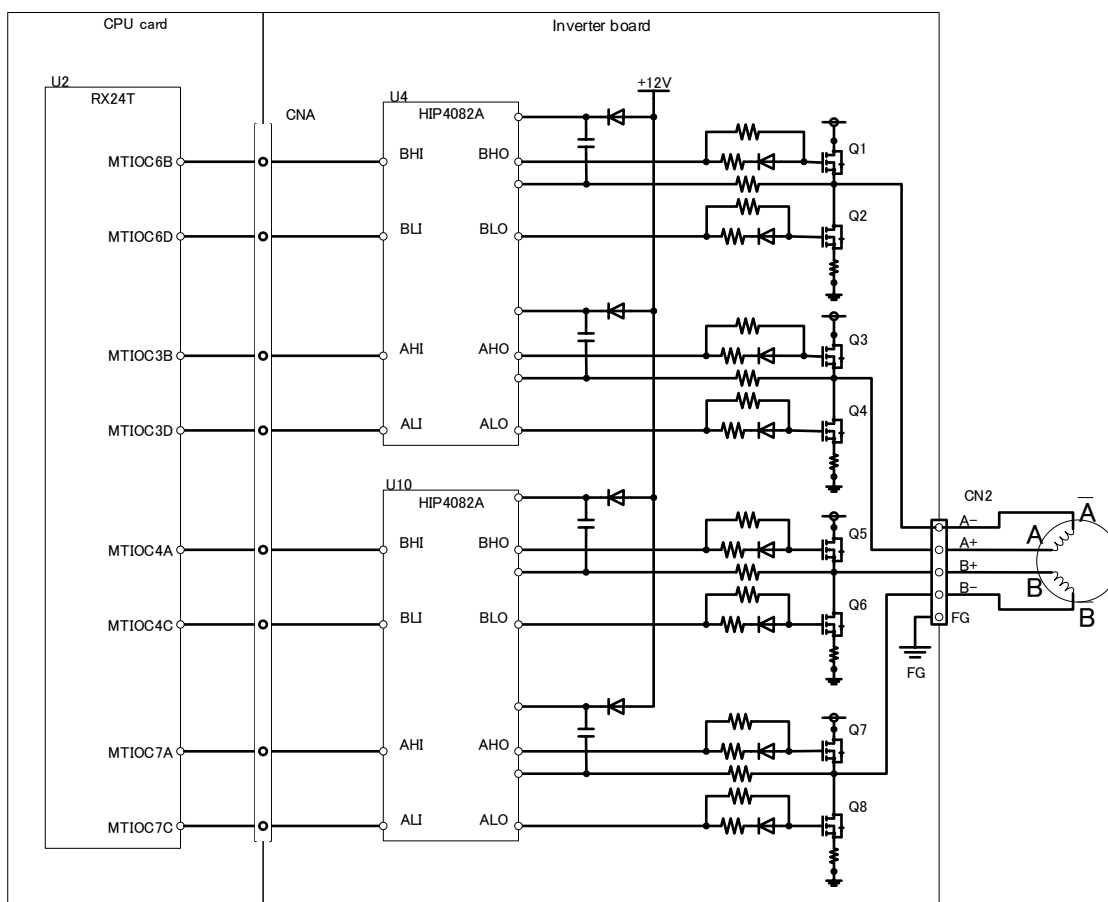

Figure 3-5 Inverter Circuit

3.4.3 Current Detection

This product has a current detection circuit for measuring the motor current. The current detection circuit converts phase currents to voltage signals and inputs them to the A/D converter. Figure 3-6 shows the circuit configuration. Table 3-7 shows the connection.

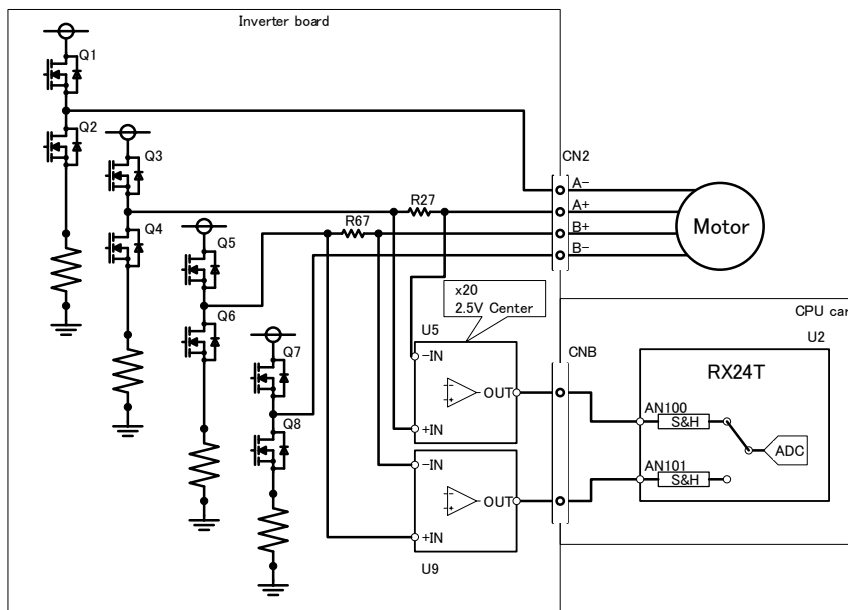

Figure 3-6 Current Detection Circuit

Table 3-7 Motor Current Detection Signal Board-to-Board Connection

Inverter board		Board-to-board connector	CPU card
Measurement target	Current detection amplifier		Connection destination (RX24T)
	Input	Output	
Phase A shunt R27+	U5.8 (IN+)	U5.5 (OUT)	U2.91
Phase A shunt R27-	U5.1 (IN-)		CNB.3
Phase B shunt R67+	U9.8 (IN+)	U9.5 (OUT)	U2.89
Phase B shunt R67-	U9.1 (IN-)		CNB.4

The relationship between the current value of the shunt resistor I_{shunt} in the current detection circuit and the A/D conversion value N_{ADC} is expressed by Equation 1. Table 3-8 lists typical values.

$$N_{ADC} = \frac{I_{shunt} \times R_{shunt} \times G \times 2^{12}}{V_{AVCC}} = \frac{I_{shunt} \times 0.025 \times 10 \times 2^{12}}{5} \quad \text{Equation 1}$$

- I_{shunt} A Current value of the shunt resistor
- R_{shunt} Ω Shunt resistance
- G V/V Current detection amplifier gain
- V_{AVCC} V Analog supply voltage
- N_{ADC} LSB A/D conversion value

Table 3-8 Motor Phase Current and Corresponding Output Voltage of the Current Detection Amplifier

Current value I_{shunt}	4 A	2 A (rated)	0 A	-2 A (rated)	-4 A
Potential difference across shunt resistor	0.2 V±1%	0.1 V±1%	0.0 V±1%	-0.1 V±1%	-0.2 V±1%
Output voltage	4.5 V±2%	3.5 V±2%	2.5 V±2%	1.5 V±2%	0.5 V±2%
A/D conversion value $N_{ADC}(*1)$	3685 LSB	2866 LSB	2048 LSB	1228 LSB	409 LSB

*1 Reference value in which the error of the A/D converter is not included

3.4.4 Voltage Detection

This product has a voltage divider for measuring the supply voltage and voltage of each phase of the motor. The output of the voltage divider is connected to the A/D converter on the RX24T. Figure 3-7 shows the circuit configuration. Table 3-9 lists the connection destinations.

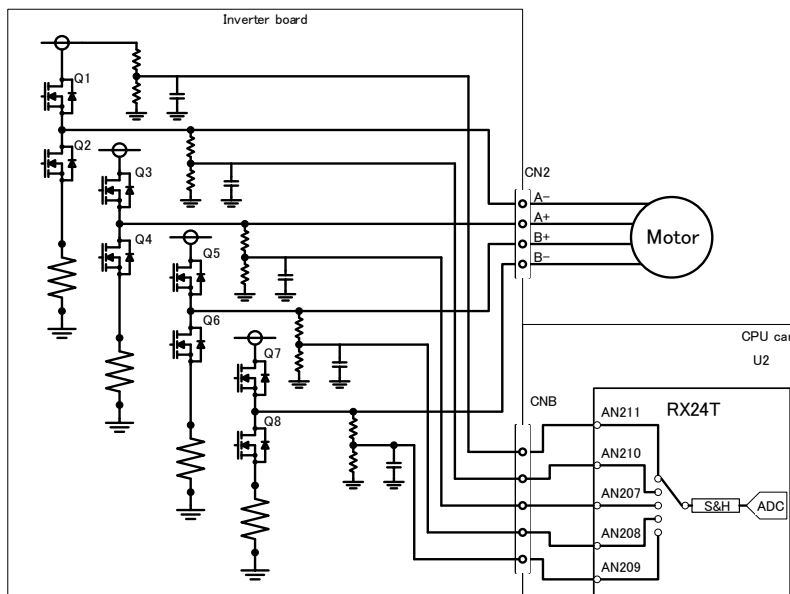

Figure 3-7 Voltage Detection Circuit

Table 3-9 Voltage Detection Signal Board-to-Board Connection

Inverter board	Board-to-board connector	CPU card
Measurement target		Connection destination (RX24T: U2)
Inverter supply voltage	CNB.8	U2.78 (P55/AN211)
Phase A+ voltage	CNB.10	U2.82 (P51/AN207)
Phase B+ voltage	CNB.11	U2.81 (P52/AN208)
Phase B- voltage	CNB.12	U2.80 (P53/AN209)
Phase A- voltage	CNB.13	U2.79 (P54/AN210)

The relationship between the supply voltage and A/D conversion result is expressed by Equation 2. Table 3-10 lists typical values.

$$N_{ADC} = \frac{470}{10 \times 10^3 + 470} \times V_{in} \times 2^{12} \quad \text{Equation 2}$$

- V_{in} V Input voltage value
- V_{AVCC} V Analog supply voltage
- N_{ADC} LSB A/D conversion value

Table 3-10 Relationships among the Input Voltage, Output Voltage, and A/D Conversion Value

Supply voltage	A/D input voltage	A/D conversion value *1
24 V	1.077 V	882 LSB
36 V	1.616 V	1323 LSB
48 V	2.155 V	1765 LSB

*1 Reference value in which the error of the A/D convertor is not included

3.5 Sensor Interfaces

3.5.1 Resolver

This product has a resolver/digital converter IC (RDC IC). The RDC IC converts the analog signal output from the resolver to the phase-modulated digital signal output. For the specifications of the RDC IC, refer to "RDC IC User's Manual (r03uz0002)".

The connector for connecting the resolver is of a plug/socket type, which allows you to connect and disconnect the resolver easily. Figure 3-8 shows the location of the resolver connector supplied with this product. Table 3-11 lists connection information of the resolver motor and resolver connector.

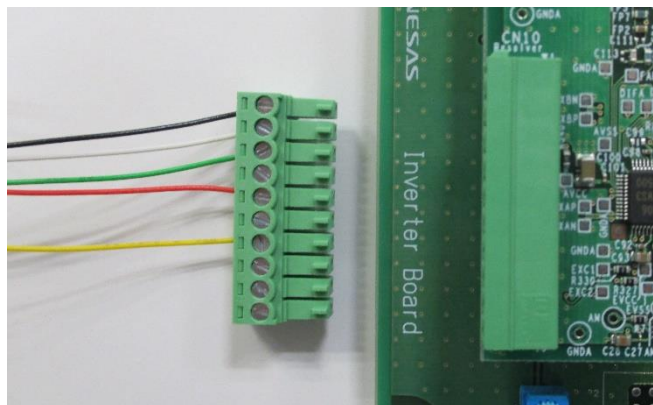

Figure 3-8 Connector for Connecting the Resolver

Table 3-11 Resolver Connector Connection

Connector	Signal name	Connection destination		Resolver cable color
CN10.1	cos-	RDC IC	U21.28 (EXCOUT2) via U21.17 (XBN) and R335	Black
CN10.2	EXOUT1	RDC IC	U21.26 (EXCOUT1) and U21.29 (EXCFBP) via R335	White
CN10.3	cos+	RDC IC	U21.28 (EXCOUT2) via U21.18 (XBP) and R335	Green
CN10.4	EXOUT1	RDC IC	U21.26 (EXCOUT1) and U21.29 (EXCFBP) via R335	-
CN10.5	sin+	RDC IC	U21.28 (EXCOUT2) via U21.23 (XAP) and R335	Red
CN10.6	EXOUT1	RDC IC	U21.26 (EXCOUT1) and U21.29 (EXCFBP) via R335	-
CN10.7	sin-	RDC IC	U21.28 (EXCOUT2) via U21.24 (XAN) and R335	Yellow
CN10.8	EXOUT1	RDC IC	U21.26 (EXCOUT1) and U21.29 (EXCFBP) via R335	-
CN10.9	shield	Power supply	GND_A	-
CN10.10	shield	Power supply	GND_A	-

3.5.2 Encoder

This product supports encoder A/B/Z signal input. The signals are input to the MCU via the 5-V pull-up resistor, RC filter, and buffer IC. Figure 3-9 shows the location of the encoder connector. Table 3-12 lists connection information of the encoder and connector. Table 3-13 lists the specifications of the input signals. The connector is not mounted at the factory. To use an encoder, mount a 2.54 mm pitch connector.

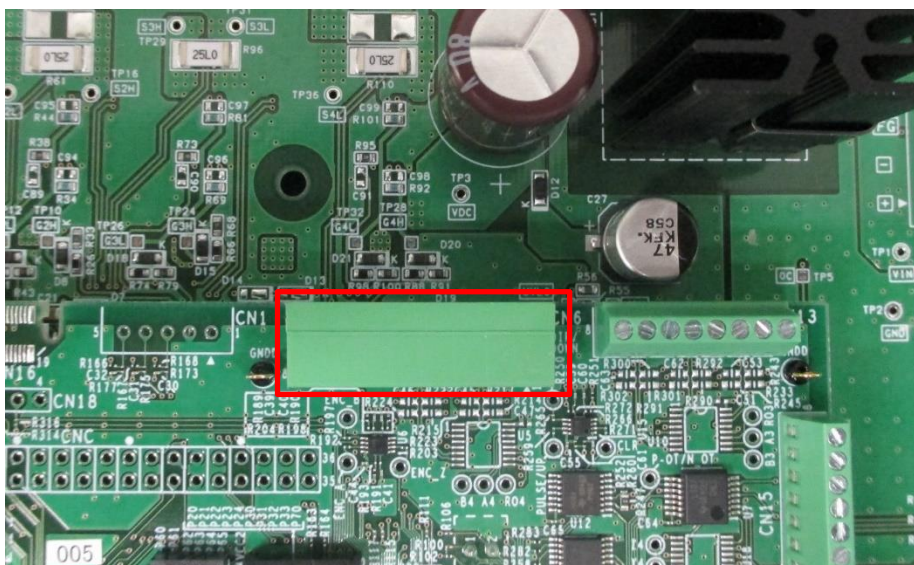

Figure 3-9 Encoder Connector

Table 3-12 Encoder Signal Connector Connection Information

Connector	Pin function	Connection destination (RX24T)	
CN6.1	5 V	Power supply	+5V_D
CN6.2	Phase A	RX24T	U2.58 (P33/MTCLKA)*1
CN6.3	GND	Power supply	GND_D
CN6.4	Phase B	RX24T	U2.59 (P32/MTCLKB)*1
CN6.5	GND	Power supply	GND_D
CN6.6	Phase Z	RX24T	U2.36 (PA5/MTIOC1A)*1
CN6.7	GND	Power supply	GND_D
CN6.8	GND	Power supply	GND_D

*1 Via the positive logic buffer IC

Table 3-13 Encoder Signal Input Specifications

Pulse rate	200 kp/r (max)
Input signal type	Open collector
Connector applicable wire	Cross section: 0.14 to 0.5 mm ² AWG: 20 to 26
Connector type	3.5 mm pitch plug/socket terminal block

3.5.3 Origin/Limit Sensors

This product supports the photoelectric sensor signal input for origin/limit sensors. It has a pull-up resistor on the board for supporting NPN sensors. The input signals are connected to the MCU all via the buffer IC. Figure 3-10 shows the locations of the origin/limit sensor connectors. Table 3-14 lists the input specifications. Table 3-15 lists connector connection information. The connectors are not mounted at the factory. To use a sensor, mount a 2.5 mm pitch connector.

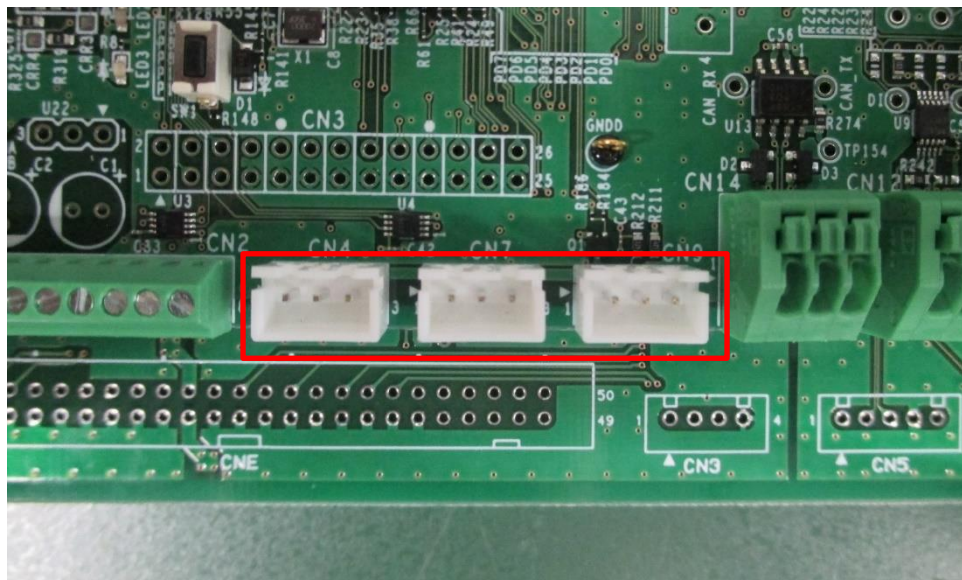

Figure 3-10 Origin/Limit Sensor Connectors

Table 3-14 Origin/Limit Sensor Input Specifications

Input signal type	Open collector
Connector	B3B-XH-A (J.S.T. Mfg. Co., Ltd.)

Table 3-15 Origin/Limit Sensor Signal Input Connector Connection Information

Connector	Signal	Connection destination
CN4.1	5V	+5V_D
CN4.2	DOG	U2.1 (PE5/IRQ0)*1
CN4.3	GND	GND_D
CN7.1	5V	+5V_D
CN7.2	N-OT	U2.7 (P00/IRQ2) *2
CN7.3	GND	GND_D
CN9.1	5V	+5V_D
CN9.2	P-OT	U2.7 (P00/IRQ2) *2
CN9.3	GND	GND_D

*1 Via the positive logic buffer IC

*2 A wired OR connection is made between N-OT and P-OT on the CPU card.

3.6 External Device Interfaces

This product has various types of external device interfaces, which allows the connection of general motor control devices.

3.6.1 Renesas Motor Workbench Communication Circuit

This product is equipped with a USB connection interface and supports support tool for motor control development Renesas Motor Workbench (RMW). RMW, an application program running on a PC, can display internal variables of a target microcontroller in waveform in real time, read and write them, and automatically extract each parameter. For details of the operation method, refer to "RMW Operation Manual (r21uz0004)".

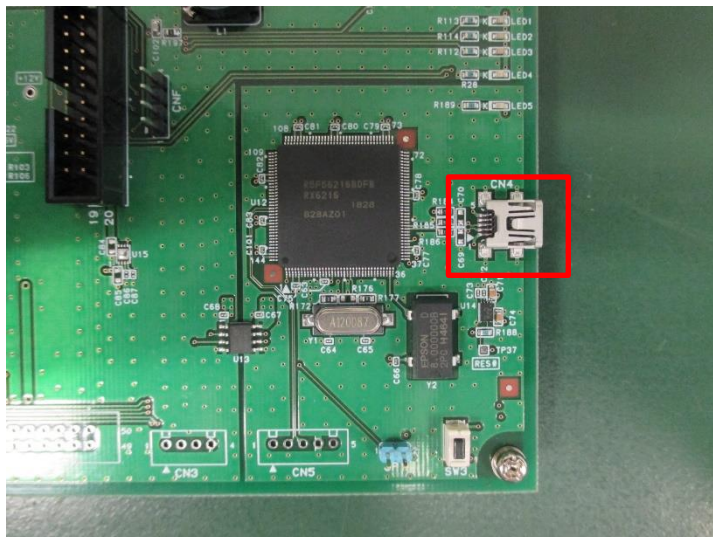

Figure 3-11 Renesas Motor Workbench Communication Circuit Connector

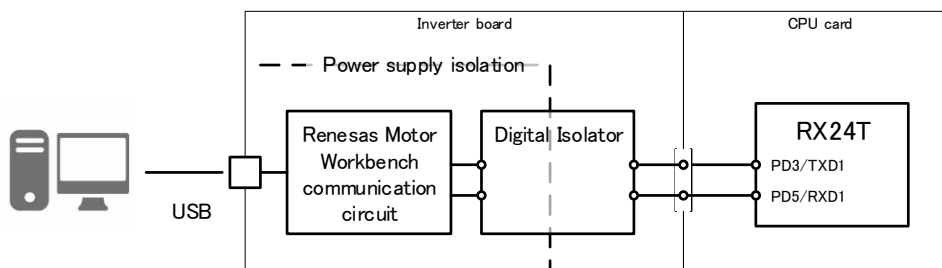

Figure 3-12 Renesas Motor Workbench Communication Circuit

3.6.2 RS-485 Communication

This product is equipped with an RS-485 communication interface, which enables asynchronous serial communication using differential signals at a maximum of 5 Mbps. It also supports a multidrop system, which enables control over transmission enable. For communication, the UART function built in the mounted MCU (R5F524TEADFP) is used. As a transceiver, the ISL3156E manufactured by Renesas Electronics Corporation is mounted. Figure 3-13 shows the location of the connector. Table 3-16 lists the communication specifications. Table 3-17 lists the connection information from the connector to the RX24T. The connector is not mounted at the factory. To use RS-485 communication, mount a 2.54 mm pitch connector.

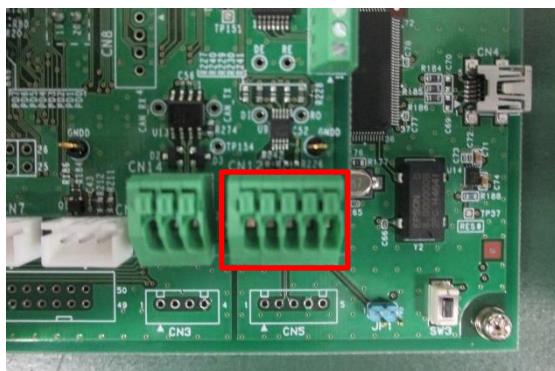

Figure 3-13 RS-485 Communication Connector

Table 3-16 RS-485 Communication Specifications

Baud rate	5 Mbps (max)
Half-/full-duplex	Full-duplex
Common-mode voltage	-7 to +12 V
Terminating resistor	100 Ω, 0.1 μF (AC termination) 
Connector applicable wire	Cross section: 0.2 to 0.5 mm ² AWG: 20 to 24

Table 3-17 RS-485 Communication Connector Connection Information

Connector	Signal	Connection destination (RS-485 transceiver differential side)	
CN12.1	Differential input +	RS-485 transceiver	U9.9 (A)
CN12.2	Differential input -	RS-485 transceiver	U9.8 (B)
CN12.3	GND	Power supply	-
CN12.4	Differential output -	RS-485 transceiver	U9.8 (Z)
CN12.5	Differential output +	RS-485 transceiver	U9.6 (Y)

Table 3-18 Connection between the RS-485 Transceiver and MCU

RS-485 transceiver CMOS level side	Connection with RX24T	Processing on the board
U9.1 (RO)	U2.34 (PB1/RXD6)	10-kΩ pull-up
U9.2 (RE#)	No connection with U2	10-kΩ pull-down
U9.3 (DE)	U2.2 (P02)	10-kΩ pull-down
U9.4 (DI)	U2.33 (PB2/TXD6)	-

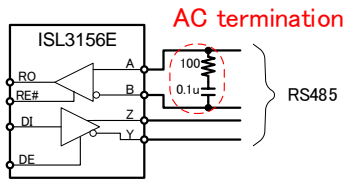
3.6.3 CAN Communication

This product is equipped with a CAN communication interface, which enables communication at a maximum of 1 Mbps. For communication, the RSCAN function built in the mounted MCU (R5F524TEADFP) is used. Figure 3-14 shows the location of the connector. Table 3-19 lists the communication specifications. Table 3-20 lists the connection information from the connector to the RX24T. The connector is not mounted at the factory. To use CAN communication, mount a 2.54 mm pitch connector.

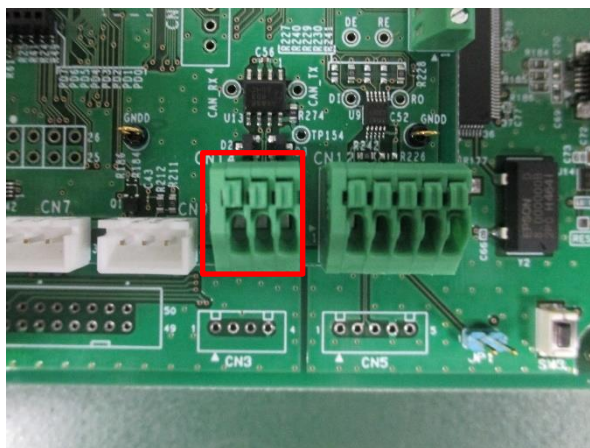

Figure 3-14 CAN Communication Connector

Table 3-19 CAN Communication Specifications

Baud rate	1 Mbps (max)
Half-/full-duplex	Half-duplex
Terminating resistance	120 Ω
Connector applicable wire	Cross section: 0.2 to 0.5 mm ² AWG: 20 to 24

Table 3-20 CAN Communication Connection Information

Connector	Connection destination
CN14.1	U13.6 (CANL)
CN14.2	GND
CN14.3	U13.7 (CANH)

Transceiver connection destination	RX24T connection destination
U13.1 (Txd)	U2.41 (PA0/CTXD0)
U13.4 (Rxd)	U2.40 (PA1/CRXD0)

3.6.4 Pulse Train Command

This product is equipped with an input interface for pulse train commands, which enables the input of pulse train commands at a maximum of 200 kp/r. The input signals are connected to the MCU all via the buffer IC. Figure 3-15 shows the location of the connector. Table 3-21 lists the input specifications. Table 3-22 lists connection information. The connector is not mounted at the factory. To use pulse train commands, mount a 2.54 mm pitch connector.



Figure 3-15 Pulse Train Command Connector

Table 3-21 Pulse Train Command Input Specifications

Pulse rate	200 kp/r (max)
Input signal type	Open collector
Connector applicable wire	Cross section: 0.14 to 0.5 mm ² AWG: 20 to 26

Table 3-22 Pulse Train Command Input Connection Relationship

Connector	Signal name	Connection destination (RX24T)	
CN13.1	5V	Power supply	+5V_D
CN13.2	PULSE/UP	RX24T	U2.8 (PE4/MTCLKC)*1
CN13.3	GND	Power supply	GND_D
CN13.4	DIR/DOWN	RX24T	U2.9 (PE3/MTCLKD)*1
CN13.5	GND	Power supply	GND_D
CN13.6	CLR	RX24T	U2.38 (PA3/MTIOC2A)*1
CN13.7	GND	Power supply	GND_D
CN13.8	GND	Power supply	GND_D

*1 Via the positive logic buffer IC

3.6.5 General-Purpose Output

This product has a general-purpose output interface for outputting various notification signals to external devices. The interface has an open-collector buffer output with a withstand voltage of 30 V and is applicable for control devices operating at 24 V. The output signals from the MCU are connected to the connector all via the buffer IC. Figure 3-16 shows the location of the connector. Table 3-23 lists the output specifications. Table 3-24 lists the connection information. The connector is not mounted at the factory. To use the general-purpose output, mount a 2.54 mm pitch connector.

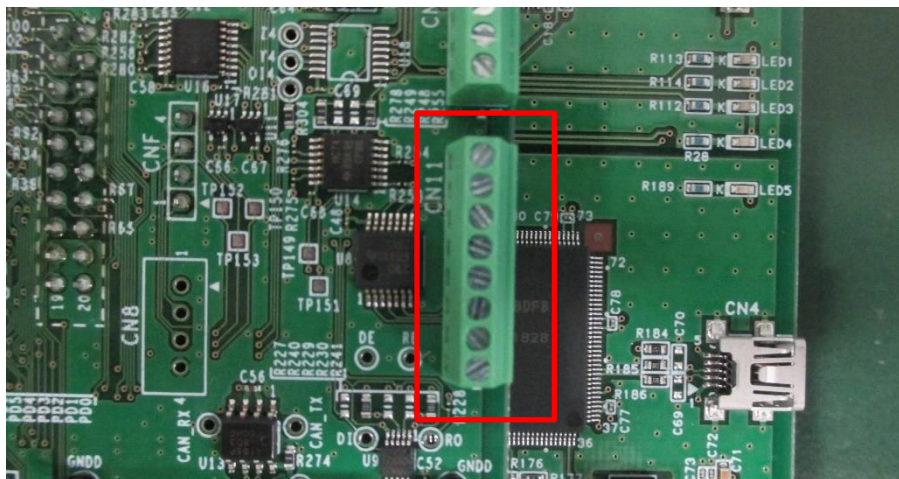

Figure 3-16 General-Purpose Output Connector

Table 3-23 General-Purpose Output Specifications

Logic	Positive
Output type	Open collector
Withstand voltage	30 V
Connector applicable wire	Cross section: 0.14 to 0.5 mm ² AWG: 20 to 26

Table 3-24 General-Purpose Output Connector Connection Information

Connector	Signal name	Connection destination (RX24T)	
CN11.1	5V	Power supply	+5V_D
CN11.2	General-purpose output (RDY)	RX24T	U2.32 (PB3)*1
CN11.3	General-purpose output (COIN)	RX24T	U2.27 (PB6) *1
CN11.4	General-purpose output (ORG)	RX24T	U2.28 (PB5) *1
CN11.5	General-purpose output (ERROR)	RX24T	U2.23 (PD2) *1
CN11.6	General-purpose output	RX24T	U2.21 (PD4) *1
CN11.7	General-purpose output	RX24T	U2.30 (PB4) *1
CN11.8	GND	Power supply	GND_D

*1 Via the open-collector output IC with a withstand voltage of 30 V

3.6.6 General-Purpose Input

This product has a general-purpose input interface for inputting various notification signals from external devices. The interface has a pull-up circuit, assuming that open-collector signals are input. The input signals are connected to the MCU all via the buffer IC. The connector is also used for the analog input. Figure 3-17 shows the location of the connector. Table 3-25 lists the input specifications. Table 3-26 lists the connection information. The connector is not mounted at the factory. To use the general-purpose input, mount a 2.54 mm pitch connector.

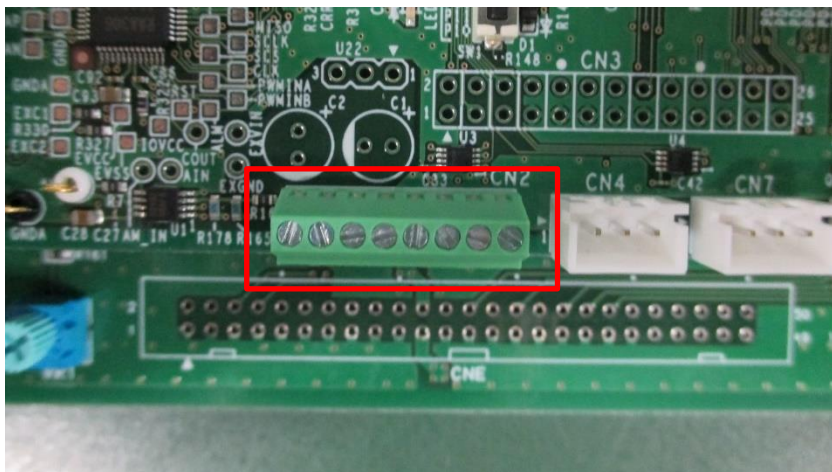

Figure 3-17 General-Purpose Input Connector

Table 3-25 General-Purpose Input Specifications

Logic	Positive
Input type	Pull-up/hysteresis input buffer
Withstand voltage	0 to 5 V
Connector applicable wire	Cross section: 0.14 to 0.5 mm ² AWG: 20 to 26

Table 3-26 General-Purpose Input Connector Connection Information

Connector	Signal name	Connection destination (RX24T)	
CN2.4	GND	Power supply	GND_D
CN2.5	General-purpose input	RX24T	U2.69 (P65)*1
CN2.6	General-purpose input	RX24T	U2.26 (PB7)*1
CN2.7	General-purpose input (SVON)	RX24T	U2.100 (P10)*1
CN2.8	5V	Power supply	+5V_D

*1 Via the positive logic buffer IC

3.6.7 Analog Input

This product has an analog input circuit for inputting analog commands from external devices or general-purpose analog signals. When the input end is open, a voltage of $AVCC/2 = 2.5\text{ V}$ is input to the MCU. The connector is also used for the general-purpose input. Figure 3-18 shows the location of the connector. Table 3-27 lists the input specifications. Table 3-28 lists the connection information. The connector is not mounted at the factory. To use the analog input, mount a 2.54 mm pitch connector.

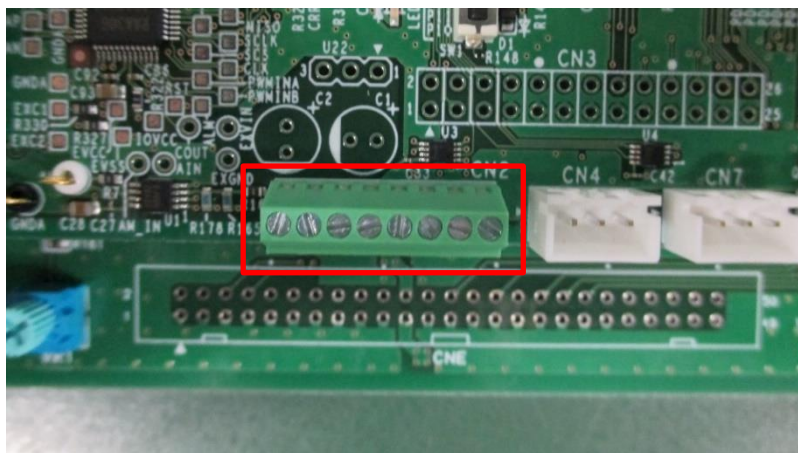

Figure 3-18 Analog Input Connector

Table 3-27 Analog Input Specifications

Input voltage range [V]	0 to 5 V
Input characteristics	<p>Two pull-up/pull-down resistors with a resistance of $470\text{ k}\Omega \pm 1\%$ When the input end is open: 2.5 V</p>
Connector applicable wire	<p>Cross section: $0.14\text{ to }0.5\text{ mm}^2$ AWG: 20 to 26</p>

Table 3-28 Analog Input Connection Information

Connector	Signal name	Connection destination	
CN2.1	GND	Power supply	GND_A
CN2.2	Analog input	RX24T	U2.70 (P64/AN204) *1
CN2.3	5V	Power supply	+5V_A

*1 Via the buffer configuration op-amp

3.7 User Interfaces

3.7.1 LEDs

This product has four LEDs on the inverter board and three LEDs on the CPU card. Two LEDs on the CPU card are connected to the same MCU pins to which LEDs on the inverter board are connected. Figure 3-19 shows the locations of the LEDs. Table 3-29 lists the connection information.

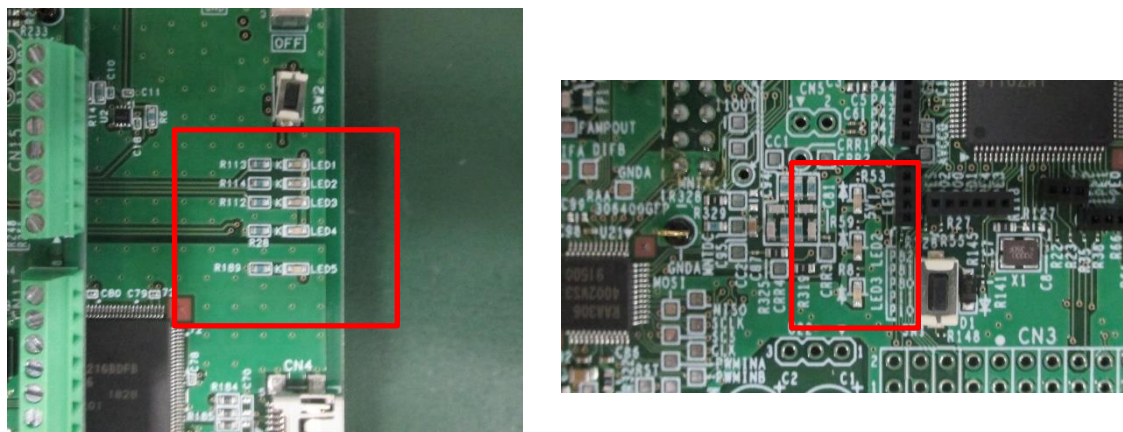

Figure 3-19 LEDs

Table 3-29 LED On Conditions and Connection Information

LED	On condition	Off condition	Board-to-board connector	Connection destination
Inverter board: LED1	Port output: Low	Port output: High	CNA.1	CPU card: U2.97 (RX24T P81)
Inverter board: LED2	Port output: Low	Port output: High	CNA.2	CPU card: U2.98 (RX24T P80)
Inverter board: LED3	Port output: Low	Port output: High	CNA.3	CPU card: U2.39 (RX24T PA2)
Inverter board: LED4	5-V supplied	5-V supply stopped	-	5-V power supply (+5V_D)
CPU card: LED1	Port output: Low	Port output: High	-	CPU card: U2.97 (RX24T P81)
CPU card: LED2	Port output: Low	Port output: High	-	CPU card: U2.98 (RX24T P80)
CPU card: LED3	5-V supplied	5-V supply stopped	-	5-V power supply (+5V_D)

3.7.2 Switches

This product has an MCU reset switch and two switches connected to MCU pin functions. Figure 3-20 shows the locations of the switches. Table 3-30 lists the connection information.

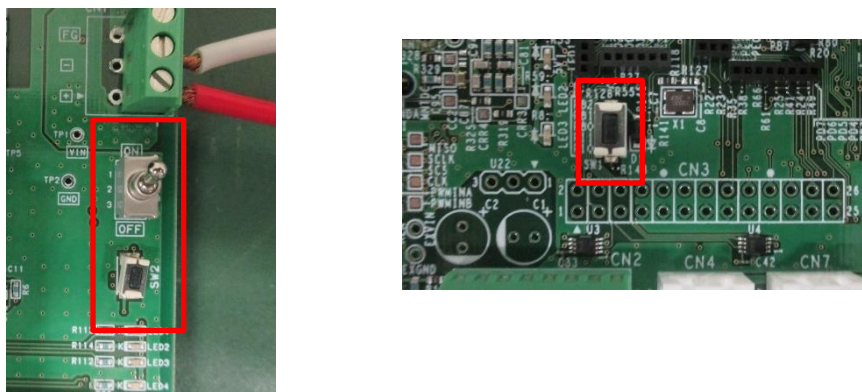

Figure 3-20 Locations of the Switches

Table 3-30 Switch Input Levels and Connection Information

Switch	Switch type	Input	Board-to-board connector	Connection destination
Inverter board: SW1	Toggle switch	Lever OFF position: High Lever ON position: Low	CNA.13	CPU card: U2.76 (RX24T P61)
Inverter board: SW2	Tact switch	Released: High Pressed: Low	CNA.14	CPU card: U2.10 (RX24T P62)
CPU card: SW1	Tact switch	Released: High Pressed: Low	-	CPU card: U2.10 (RX24T RES#)

3.7.3 Variable Resistor

This product has a variable resistor. Figure 3-21 shows the location. Table 3-31 lists the specifications.



Figure 3-21 Location of the Variable Resistor

Table 3-31 Specifications and Connection Information of the Variable Resistor

Output voltage range	0 to AVCC
Board-to-board connector	CNB.15
Connection destination	CPU card: U2.77 (RX24T P60/AN200)

3.8 Pin Assignments

3.8.1 MCU Pin Function Assignments

Table 3-32 MCU Pin Function Assignments (1/3)

#	Port	Module	Function	IN/OUT	Connection destination	Signal name
1	PE5	ICU	IRQ0	IN	Sensor (origin)	DOG
2	P02	Port	P02	OUT	Upper device (RS-485)	RS485_DE-
3	VSS	Power	VSS	-	Power supply	GND_D
4	P00	ICU	IRQ2	IN	Sensor (limit)	N-OT, P-OT
5	VCL	Power	VCL	-	Power supply	VCL
6	MD	System	MD	IN/OUT	E2 on board	FINE
7	P01	POE	POE12#	IN	RDC IC	RDC_ALARM
8	PE4	MTU	MTCLKC	IN	Upper device (Pulse command)	PULSE/UP
9	PE3	MTU	MTCLKD	IN	Upper device (Pulse command)	DIR/DOWN
10	RES#	System	RES#	IN	Reset circuit/E2 on board	MCU_RESET
11	XTAL	System	XTAL	-	Oscillator	XTAL
12	VSS	Power	VSS	-	Power supply	GND_D
13	EXTAL	System	EXTAL	-	Oscillator	EXTAL
14	VCC	Power	VCC	-	Power supply	VCC_D
15	PE2	Not used	-	-	-	-
16	PE1	Not used	-	-	-	-
17	PE0	MTU9	MTIOC9B	OUT	RDC IC	CARRIER2
18	PD7	Not used	-	-	-	-
19	PD6	RSPI	SSLA0	OUT	RDC IC	SPI_SCS
20	PD5	UART1	RXD1	IN	RMW communication circuit	ICS_RX
21	PD4	Port	PD4	OUT	Upper device (sequence output)	GPOUTPUT
22	PD3	UART1	TXD1	OUT	RMW communication circuit	ICS_TX
23	PD2	Port	PD2	OUT	Upper device (sequence output)	ERROR
24	PD1	Port	PD1	OUT	Sensor power ON/OFF	SPON
25	PD0	Not used	-	-	-	-
26	PB7	Port	PB7	IN	Upper device (sequence input)	GPINPUT
27	PB6	Port	PB6	OUT	Upper device (sequence output)	COIN
28	PB5	Port	PB5	OUT	Upper device (sequence output)	ORG
29	VCC	Power	VCC	-	Power supply	VCC_D
30	PB4	Port	PB4	OUT	Upper device (sequence output)	GPOUTPUT
31	VSS	Power	VSS	-	Power supply	GND_D
32	PB3	Port	PB3	OUT	Upper device (sequence output)	RDY
33	PB2	UART6	TXD6	OUT	Upper device (RS-485)	RS485_TX
34	PB1	UART6	RXD6	IN	Upper device (RS-485)	RS485_RX
35	PB0	TMR	TMO0	OUT	RDC IC	PWMINA
36	PA5	MTU1	MTIOC1A	IN	Encoder	ENC_Z
37	PA4	RSPI	RSPCKA	OUT	RDC IC	SPI_SCLK
38	PA3	MTU2	MTIOC2A	IN	RDC IC	COUT
39	PA2	Port	PA2	OUT	LED	LED3#
40	PA1	RSCAN	CRXD0	IN	Upper device (CAN)	CAN_RX

Table 3-33 MCU Pin Function Assignments (2/3)

#	Port	Module	Function	IN/OUT	Connection destination	Signal name
41	PA0	RSCAN	CTXD0	OUT	Upper device (CAN)	CAN_TX
42	VCC	Power	VCC	-	Power supply	VCC_D
43	P96	Not used	-	-	-	-
44	VSS	Power	VSS	-	Power supply	GND_D
45	P95	MTU67	MTIOC6B	OUT	Gate driver	A-H
46	P94	MTU67	MTIOC7A	OUT	Gate driver	B-H
47	P93	Not used	-	-	-	-
48	P92	MTU67	MTIOC6D	OUT	Gate driver	A-L
49	P91	MTU67	MTIOC7C	OUT	Gate driver	B-L
50	P90	Not used	-	-	-	-
51	P76	Not used	-	-	-	-
52	P75	MTU34	MTIOC4C	OUT	Gate driver	B+L
53	P74	MTU34	MTIOC3D	OUT	Gate driver	A+L
54	P73	Not used	-	-	-	-
55	P72	MTU34	MTIOC4A	OUT	Gate driver	B+H
56	P71	MTU34	MTIOC3B	OUT	Gate driver	A+H
57	P70	POE	POE0#	IN	Overcurrent detection circuit	HISEDE_OC#
58	P33	MTU	MTCLKA	IN	Encoder phase A	ENC_A
59	P32	MTU	MTCLKB	IN	Encoder phase B	ENC_B
60	VCC	Power	VCC	-	Power supply	VCC_D
61	P31	MTU0	MTIOC0A	OUT	RDC IC	CC
62	VSS	Power	VSS	-	Power supply	GND_D
63	P30	Not used	-	-	-	-
64	P24	D/A	DA0	OUT	Analog monitor	Analog_Mon
65	P23	RSPI	MOSIA	OUT	RDC IC	SPI_MOSI
66	P22	RSPI	MISOA	IN	RDC IC	SPI_MISO
67	P21	MTU9	MTIOC9A	OUT	RDC IC	CARRIER1
68	P20	Not used	-	-	-	-
69	P65	Port	P65	IN	Upper device (sequence input/output)	GPINPUT
70	P64	A/D	AN204	IN	Upper device (analog command)	AIN
71	AVCC2	Power	AVCC2	-	Power supply	VCC_A
72	VREF	Power	VREF	-	Power supply	VCC_A
73	AVSS2	Power	AVSS2	-	Power supply	GND_A
74	P63	Not used	-	-	-	-
75	P62	ICU	IRQ6	IN	Switch (tact)	SW2#
76	P61	ICU	IRQ5	IN	Switch (toggle)	SW1#
77	P60	A/D	AN200	IN	Variable resistor	VR1
78	P55	A/D	AN211	IN	Power supply detection	VDC
79	P54	A/D	AN210	IN	Phase voltage detection	VA-
80	P53	A/D	AN209	IN	Phase voltage detection	VB-

Table 3-34 MCU Pin Function Assignments (3/3)

#	Port	Module	Function	IN/OUT	Connection destination	Signal name
81	P52	A/D	AN208	IN	Phase voltage detection	VB+
82	P51	A/D	AN207	IN	Phase voltage detection	VA+
83	P50	A/D	AN206	IN	RDC IC	MNTOUT_DC_1
84	P47	A/D	AN103	IN	RDC IC	MNTOUT_AC_1
85	P46	Not used	-	-	-	-
86	P45	A/D	AN101	IN	Current detection amplifier	IB
87	P44	A/D	AN100	IN	Current detection amplifier	IA
88	P43	Port	P43	OUT	RDC IC	RDC_RESET
89	P42	Not used		-	-	-
90	P41	Not used		-	-	-
91	P40	Not used	-	-	-	-
92	AVCC1	Power	AVCC1	-	Power supply	VCC_A
93	AVCC0	Power	AVCC0	-	Power supply	VCC_A
94	AVSS0	Power	AVSS0	-	Power supply	GND_A
95	AVSS1	Power	AVSS1	-	Power supply	GND_A
96	P82	TMR	TMO4	OUT	RDC IC	PWMINB
97	P81	Port	P81	OUT	LED1	LED1#
98	P80	Port	P80	OUT	LED2	LED2#
99	P11	TMR	TMO3	OUT	RDC IC	RDC_CLK
100	P10	Port	P10	IN	Upper device (sequence input)	SVON

3.8.2 Board-to-Board Connector Pin Function Assignments

Table 3-35 Board-to-Board Connector CNA Connection Pins

#	Output	Signal	Connection destination (inverter board)	Connection destination (CPU card)
1	To INV	LED1#	LED1	U2.97 P81
2	To INV	LED2#	LED2	U2.98 P80
3	To INV	LED3#	LED3	U2.39 PA2
4	To INV	PWM phase A- L	Gate driver: U4.3 BLI	U2.48 P92/MTIOC6D
5	To CPU	Overcurrent detection	Comparator output: U2.1	U2.57 P70/POE0#
6	To INV	PWM phase A- H	Gate driver: U4.2 BHI	U2.45 P95/MTIOC6B
7	To INV	PWM phase B- L	Gate driver: U10.4 ALI	U2.49 P91/MTIOC7C
8	To INV	PWM phase B+ L	Gate driver: U10.3 BLI	U2.52 P75/MTIOC4C
9	To INV	PWM phase A+ L	Gate driver: U4.4 ALI	U2.53 P74/MTIOC3D
10	To INV	PWM phase B- H	Gate driver: U10.7 AHI	U2.46 P94/MTIOC7A
11	To INV	PWM phase B+ H	Gate driver: U10.2 BHI	U2.55 P72/MTIOC4A
12	To INV	PWM phase A+ H	Gate driver: U4.7 AHI	U2.56 P71/MTIOC3B
13	To CPU	SW1	SW1	U2.76 P61
14	To CPU	SW2	SW2	U2.10 P62
15	To CPU	Digital 5V	+5V_D	+5V_D
16	To CPU	Digital 5V	+5V_D	+5V_D
17	To CPU	Digital GND	GND_D	GND_D
18	To CPU	Digital GND	GND_D	GND_D
19	-	-	-	-
20	-	-	-	-

Table 3-36 Board-to-Board Connector CNB Connection Pins

#	Output	Signal	Connection destination (inverter board)	Connection destination (CPU card)
1	To CPU	Analog 5V	+5V_A	+5V_A
2	To CPU	Analog 5V	+5V_A	+5V_A
3	To CPU	-	GND_A	-
4	To CPU	-	GND_A	-
5	To CPU	Phase A current detection	Current detection amplifier: U5.5	U2.91 P40/AN100
6	To CPU	Phase B current detection	Current detection amplifier: U9.5	U2.89 P41/AN101
7	-	-	-	U2.85 P46
8	To CPU	Supply voltage divider	R2, R4	U2.78. P55/AN211
9	-	-	-	-
10	To CPU	Phase A+ voltage divider	R32, R40	U2.82 P51/AN207
11	To CPU	Phase B+ voltage divider	R72, R77	U2.81 P52/AN208
12	To CPU	Phase B- voltage divider	R105, R108	U2.80 P53/AN209
13	To CPU	Phase A- voltage divider	R12, R20	U2.79 P54/AN210
14	-	-	-	U2.91 P40
15	To CPU	Volume	VR1	U2.77 P60/AN200
16	-	-	-	-
17	To CPU	Digital 5V	+5V_D	+5V_D
18	To CPU	Digital 5V	+5V_D	+5V_D
19	To CPU	Analog ground	GND_A	GND_A
20	To CPU	Analog ground	GND_A	GND_A

Table 3-37 Board-to-Board Connector CN10 Connection Pins

#	Output	Signal	Connection destination (inverter board)	Connection destination (CPU card)
1	To INV	RMW communication: Transmission	U13.3 A2	U2.22 PD3/TXD1
2	-	Digital ground	GND_D	GND_D
3	To CPU	RMW communication: Reception	U13.2 A1	U2.20 PD5/RXD1
4	-	Digital ground	GND_D	GND_D

4. How to Flash Program MCU

This chapter describes how to write a sample program to MCU flash memory with e2studio. Download the sample code “Vector Control of a Two-Phase Stepping Motor Incorporating a Resolver Sensor”(R03AN0014) from the product page.

Note that the capture screens in this manual may be different from the actual ones.

(1) Connect CPU card to PC

Connect the supplied USB cable to CN17 (USB mini-B connector) on the CPU card and the USB connector on the PC

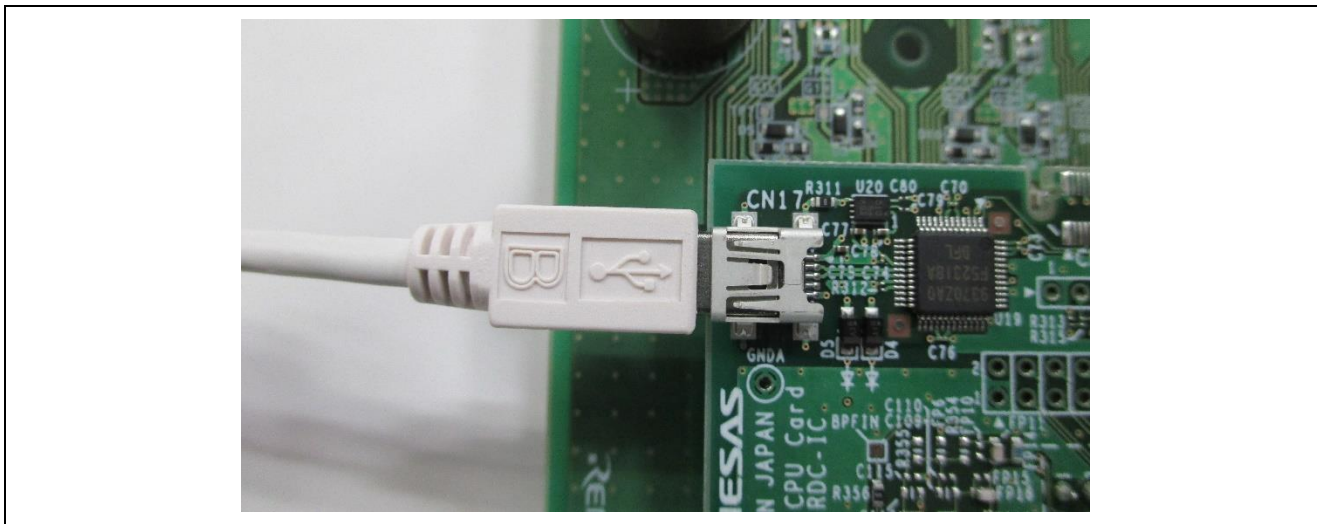

Figure 4-1 Connecting the Cable

(2) Launch e2studio and import sample project

Import the sample project (for e2studio) into e2studio.

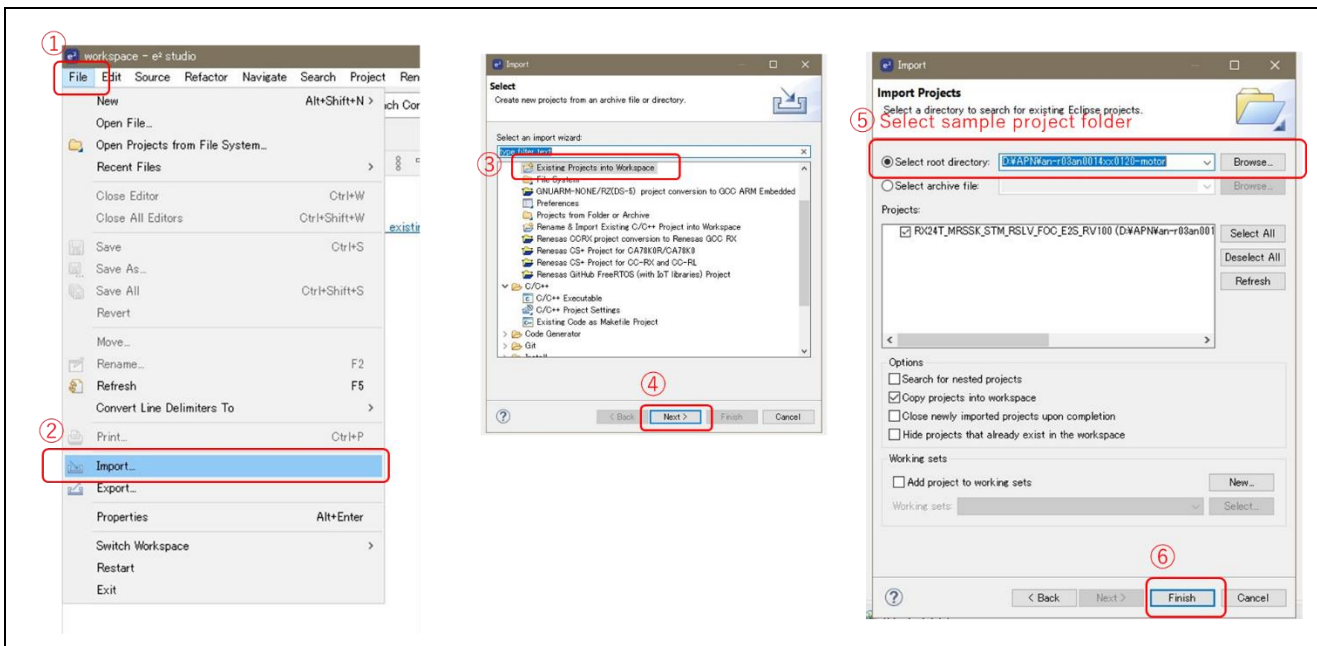

Figure 4-2 Import project

(3) Configure Toolchain

Click the property of the project and configure the toolchain for your environment. The toolchains and versions you can select depend on the installed toolchain in your e2studio.

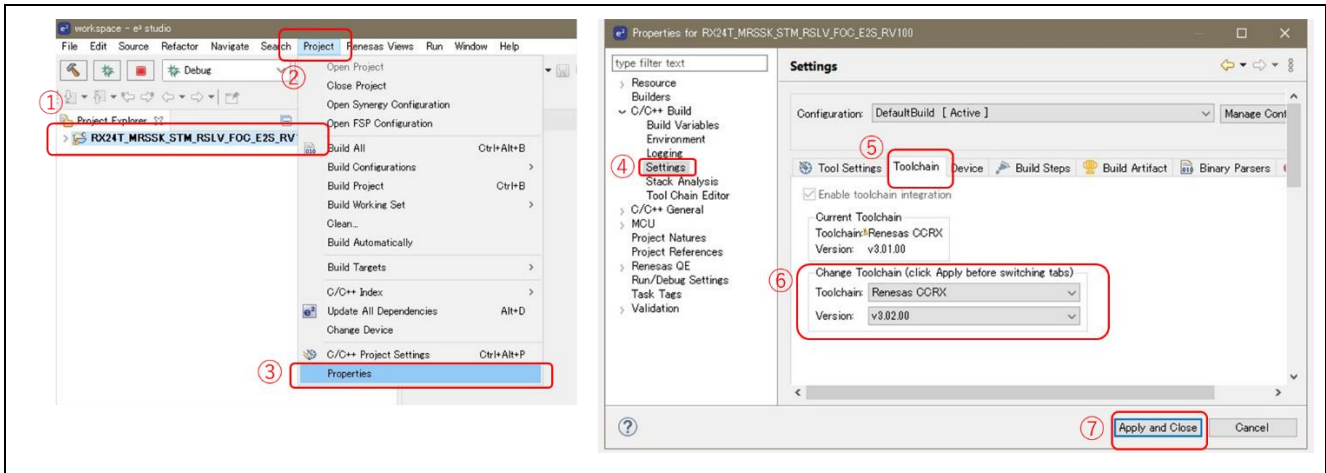

Figure 4-3 Toolchain configuration

(4) Build project

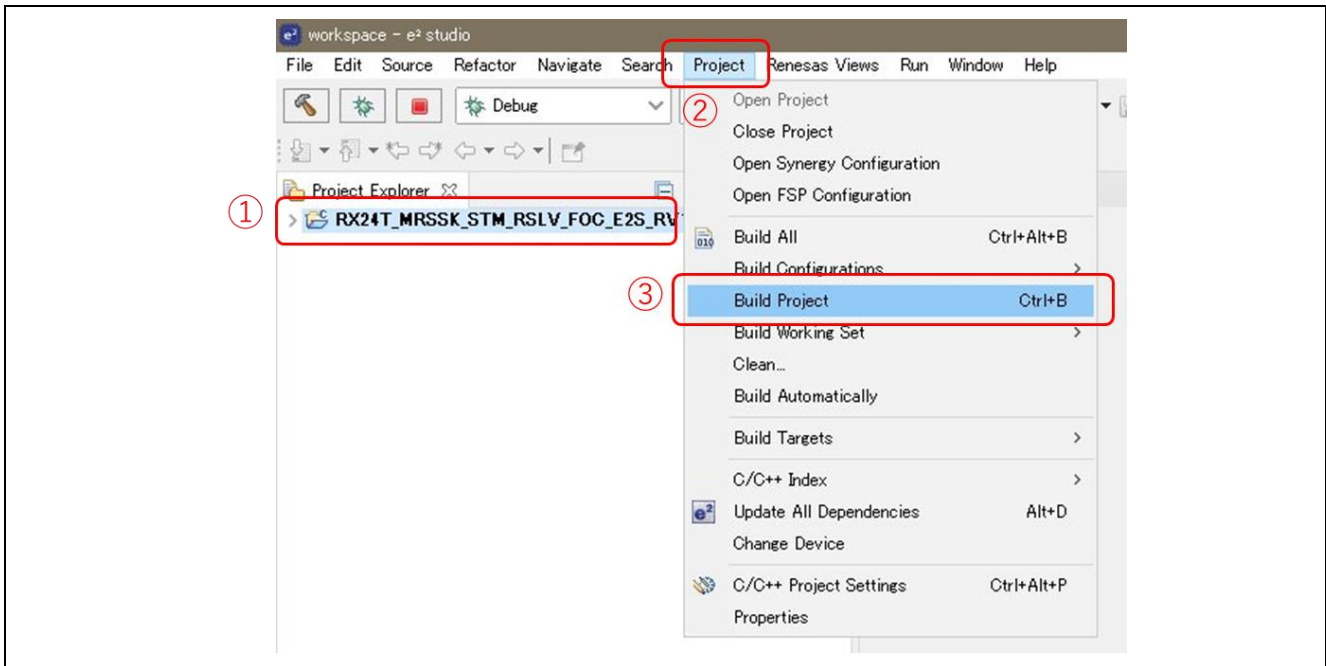

Figure 4-4 Build project

(5) Write the program into CPU card

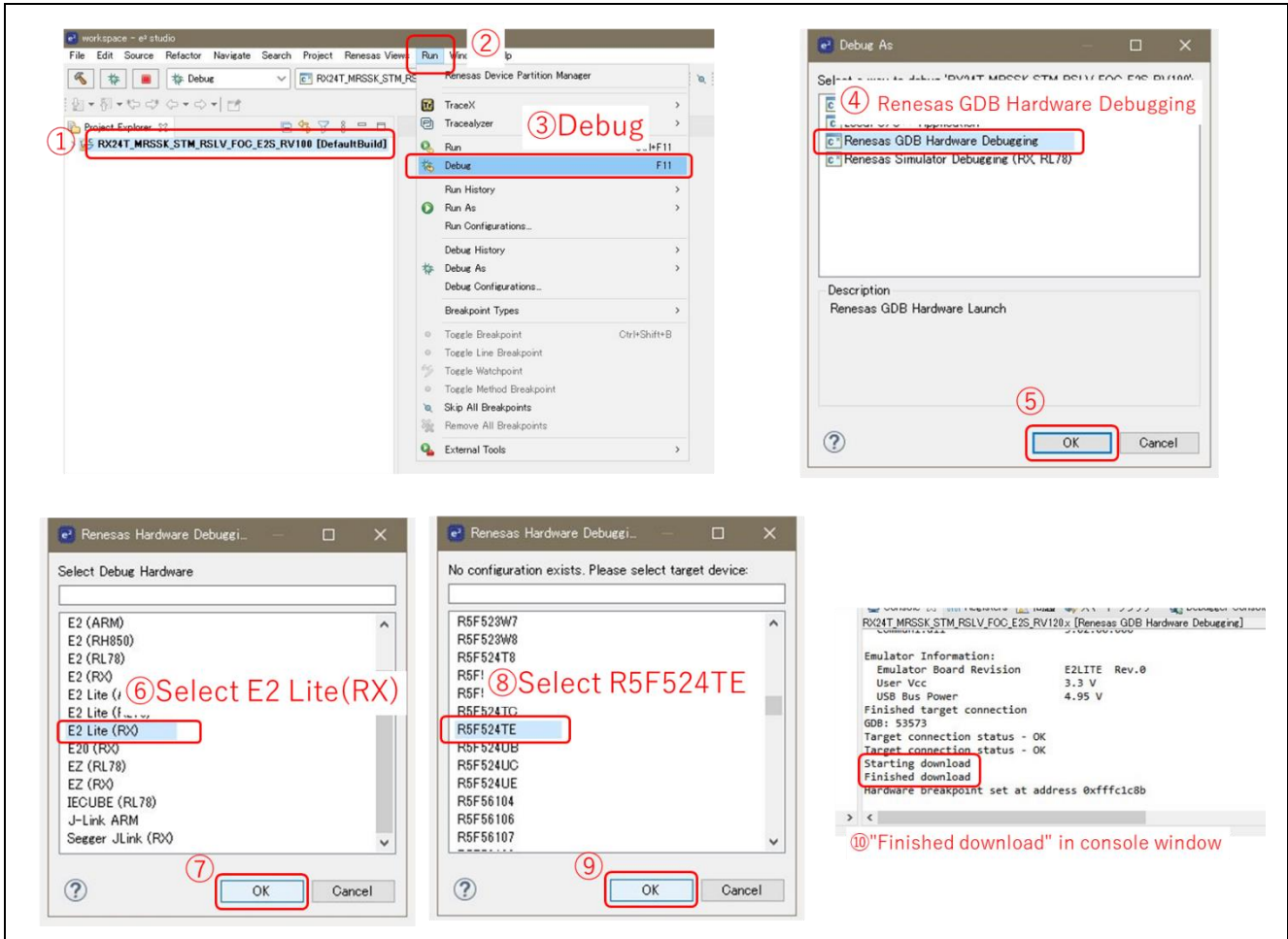

Figure 4-5 Flash programming

(6) Disconnect CPU card from PC

Click disconnect and detach USB cable from the CPU card.

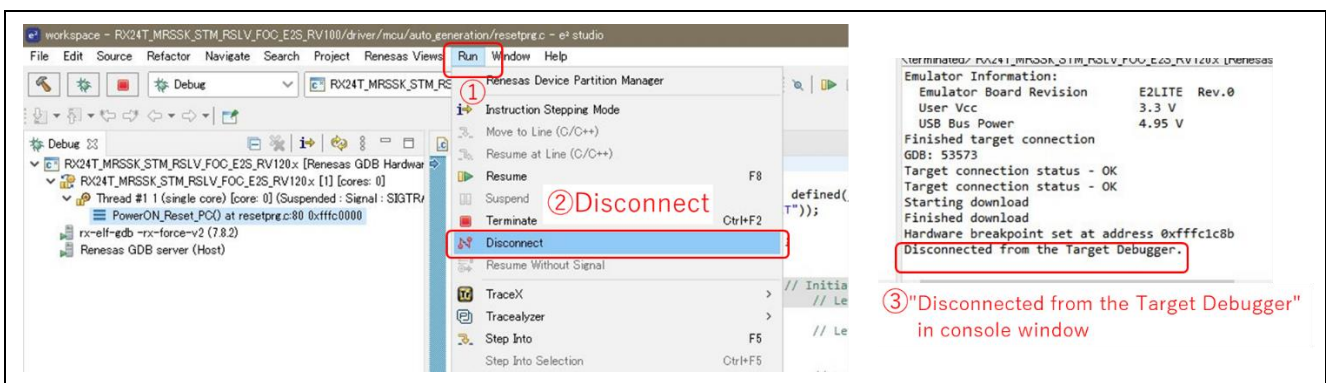

Figure 4-6 Disconnect CPU card

Website and Support

Renesas Electronics Website

<http://japan.renesas.com/>

Inquiries

<http://japan.renesas.com/contact/>

All trademarks and registered trademarks are the property of their respective owners.

Revision History

Rev.	Date	Description	
		Revised part	Summary
1.00	Nov. 29, 2019	-	First edition
1.10	Nov. 6, 2020	Added Section 4	Added how to flash program MCU
1.20	Feb.21, 2022		Modified Table 3-11