

Total solder points: 167

Difficulty level: *beginner* 1 2 3 4 5 *advanced*

DMX CONTROLLED RELAY

K8072

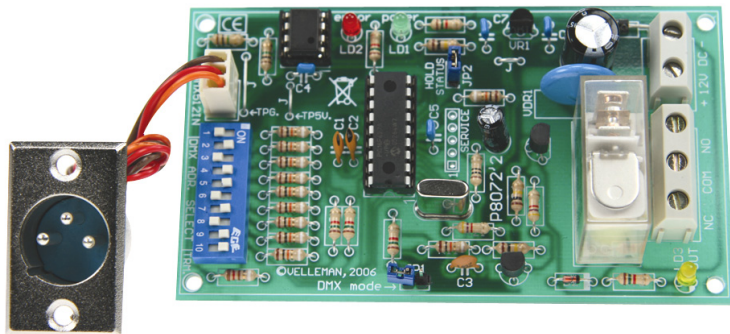

Control a relay by means of the well-known DMX512 protocol.

This Kit allows you to control a relay by means of the well-known DMX512 protocol. This protocol was developed by USITT in 1986 to control dimmers, scanners, moving-head spots and other lighting devices with a simple wiring. In some cases, a simple ON/OFF selection is desired. This is where this K8072 comes in. It is actually a bus-controlled power driver. The relay will be activated when the DMX value of the set channel equals 140 or more and turns off when the value is 120 or less.

Together with our K8062/VM116, a computer-controlled automation will be very easy to build.

FEATURES:

- System addresses: 512 unique addresses, DIP switch settable.
- LED indication for power supply, relay output status and error situation.
- "Safe DMX data stream" mode reducing interference to a minimum.
- "Relay hold" function in case of DMX signal loss.
- Stand-alone "test" mode
- Control: DMX-512, 3-pin XLR plug (incl.)

SPECIFICATIONS:

- Switching Capacity: 8A
- Supply Voltage: 12VDC non-regulated
- Power Consumption: max. 100mA
- Dimensions: 105 x 60 x 30mm / 4,1 x 2,4 x 1,2"

modifications reserved

1. Assembly (Skipping this can lead to troubles !)

Ok, so we have your attention. These hints will help you to make this project successful. Read them carefully.

1.1 Make sure you have the right tools:

- A good quality soldering iron (25-40W) with a small tip.
- Wipe it often on a wet sponge or cloth, to keep it clean; then apply solder to the tip, to give it a wet look. This is called 'thinning' and will protect the tip, and enables you to make good connections. When solder rolls off the tip, it needs cleaning.
- Thin raisin-core solder. Do not use any flux or grease.
- A diagonal cutter to trim excess wires. To avoid injury when cutting excess leads, hold the lead so they cannot fly towards the eyes.
- Needle nose pliers, for bending leads, or to hold components in place.
- Small blade and Phillips screwdrivers. A basic range is fine.

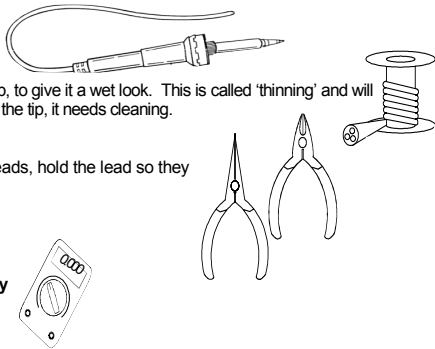

For some projects, a basic multi-meter is required, or might be handy

1.2 Assembly Hints :

- ⇒ Make sure the skill level matches your experience, to avoid disappointments.
- ⇒ Follow the instructions carefully. Read and understand the entire step before you perform each operation.
- ⇒ Perform the assembly in the correct order as stated in this manual
- ⇒ Position all parts on the PCB (Printed Circuit Board) as shown on the drawings.
- ⇒ Values on the circuit diagram are subject to changes.
- ⇒ Values in this assembly guide are correct*
- ⇒ Use the check-boxes to mark your progress.
- ⇒ Please read the included information on safety and customer service

* Typographical inaccuracies excluded. Always look for possible last minute manual updates, indicated as 'NOTE' on a separate leaflet.

1.3 Soldering Hints :

1- Mount the component against the PCB surface and carefully solder the leads

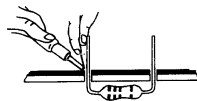

2- Make sure the solder joints are cone-shaped and shiny

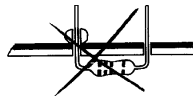
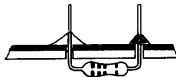

3- Trim excess leads as close as possible to the solder joint

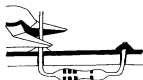

REMOVE THEM FROM THE TAPE ONE AT A TIME !

DO NOT BLINDLY FOLLOW THE ORDER OF THE COMPONENTS ONTO THE TAPE. ALWAYS CHECK THEIR VALUE ON THE PARTS LIST!

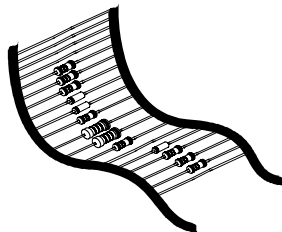

1. Jumper wires

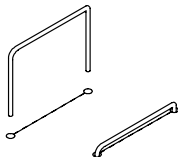

J : 3x

2. Diodes. Watch the polarity !

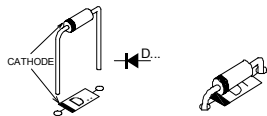

D1 : 1N4007
 D2 : 1N4148

3. Resistors

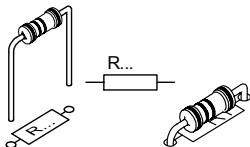

- R1 : 10K (1-0-3-B)
- R2 : 10K (1-0-3-B)
- R3 : 10K (1-0-3-B)
- R4 : 10K (1-0-3-B)
- R5 : 10K (1-0-3-B)
- R6 : 10K (1-0-3-B)
- R7 : 10K (1-0-3-B)
- R8 : 10K (1-0-3-B)
- R9 : 10K (1-0-3-B)
- R10 : 10K (1-0-3-B)
- R11 : 10K (1-0-3-B)
- R12 : 100K (1-0-4-B)
- R13 : 1K5 (1-5-2-B)
- R14 : 1K5 (1-5-2-B)
- R15 : 1K5 (1-5-2-B)
- R16 : 1K5 (1-5-2-B)
- R17 : 1K5 (1-5-2-B)
- R18 : 1K5 (1-5-2-B)
- R19 : 1M (1-0-5-B)

- R20 : 1M (1-0-5-B)
- R21 : 4K7 (4-7-2-B)
- R22 : 4K7 (4-7-2-B)
- R23 : 100K (1-0-4-B)
- R24 : 100K (1-0-4-B)
- R25 : 10 (1-0-0-B)

4. Metal film resistor

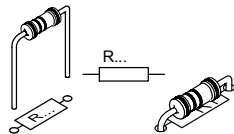

R26 : 120 (1-2-1-B-9)

5. IC sockets, Watch the position of the notch!

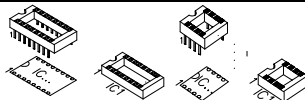

IC1 : 8p
 IC2 : 18p

6. Capacitors.

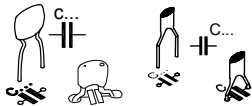

- C1 : 15pF (15)
- C2 : 15pF (15)
- C3 : 10nF (103)
- C4 : 100nF (104)
- C5 : 100nF (104)
- C6 : 100nF (104)
- C7 : 100nF (104)

7. LED's. Watch the polarity !

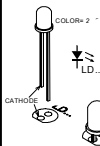

- LD1 : 3mm Green
- LD2 : 3mm Red
- LD3 : 3mm Yellow

- LD1 ➔ Power
- LD2 ➔ Error
- LD3 ➔ Out

8. DIP switch

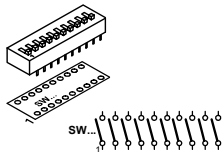

- SW1 : DMX address selection

9. Voltage regulator

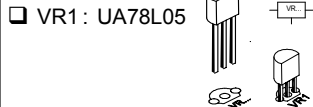

- VR1 : UA78L05

10. Transistor

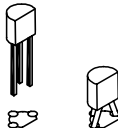

- T1 : BC557
- T2 : BC547

11. Pin header

- JP1 : 2p (DMX mode selection)
- JP2 : 2p (Hold status)

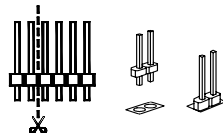

12. Board to wire connector

- SK2 : 3p DMX input

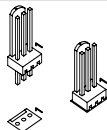

13. Quartz crystal

- X1 : 20MHz

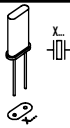

14. Terminal blocks

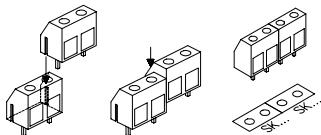

- SK1 : 2p AC input
- SK3 : 3p Relay contacts

16. VDR

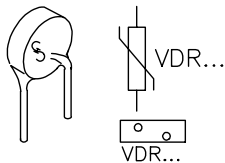

- VDR1 : VDR300 (300VAC / 385VDC)

15. Electrolytic capacitors

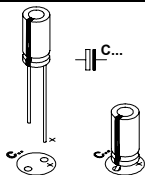

- C8 : 10 μ F / 35V
- C9 : 470 μ F / 25V

17. Relay

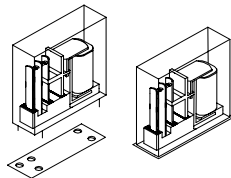

- RY1 : VR10V121C/16

18. IC's. Watch the position of the notch

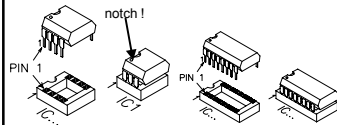

- IC1 : SN75176
- IC2 : VK8072
(programmed PIC16F627A-I/P)



CHECK THOROUGHLY ALL THE COMPONENTS FOR MISS MOUNTING, INCLUDING SOLDERING ERRORS.

19. Wiring the 3P XLR plug

Solder the 3-pole male print connector to the XLR connector using the figure below to check the accuracy of the connections (see figure 1.0)

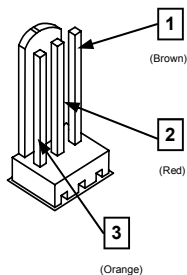

Legend :

- 1 Ground
- 2 Data -
- 3 Data +

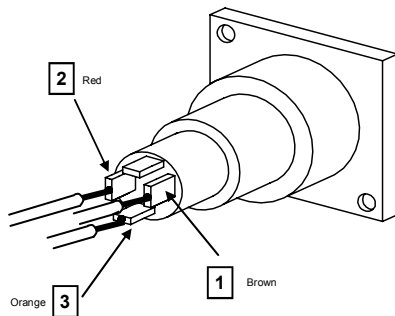
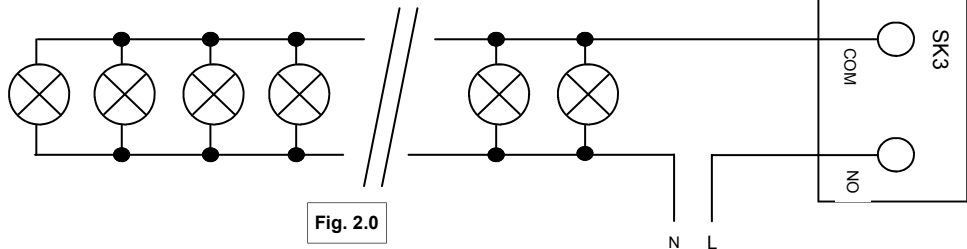

Fig. 1.0

20. Connection and Use of the DMX Switch

Connect the load (motor, light bulb or bulb group) to the relay output (SK3). Mind the max. switching power of 8A (at 230V = 1900W) for a resistive load.

Connect the DMX signal to the DMX IN input (SK2). See figure.











Remark: Some DMX controllers have a reversed DMX polarity. Swap DATA+ and DATA-.

21. Setting the DMX Channel:

Set up the DMX channel or “DMX address” by means of the DIPSWITCH, SW1. You can set up the DMX channel between 1 and 511, channel 0 is not used. The switches from 1 to 9 generate a binary digit representing the DMX channel. Switch 1 is the LSB, switch 9 is the MSB. Only modify the DMX channel when the K8072 is not plugged in. Make sure to restart the kit after every modification.

Examples :

Value		Value		Value	
1		8		64	
2		16		128	
4		32		256	

Channel 1 : dip / on : #1 (=1)
 Channel 5 : dip / on : #1 + #3 (=1+4= 5)
 Channel 9 : dip / on : #1 + #4 (=1+8=9)
 Channel 69 : dip / on : #1 + #3 + #7 (=1+4+64=69)

Please go to our website (www.velleman.be) and consult the handy graphical help program showing the position of the switches. Setting up will become easy!



Terminator:

The DMX protocol implies that the last device in a series must be fitted with a 120 ohms terminator. The kit has already been fitted with the terminator. Activate it as follows: position DIP switch nr 10 to ON. The terminator must be deactivated in all other devices which means it must be positioned to OFF.



1. Position switch 10 of SW1 to ON when using the K8072 as sole connected DMX device or when this K8072 is the last device in a series (see "Terminator").
2. Connect a 12V regulated power supply to input 12VDC (SK1) and switch on.
3. The green power LED LD1 will light when the kit is turned on.
4. When increasing the DMX value of the channel over 140, the relay will activate and LD3 "OUT" will light. LD3 will turn off and the relay will deactivate when decreasing the DMX value under 120. Values between 120 and 140 serve as hysteresis and keep the relay from cycling.

LED LD2 “Error” Functions:

LD2, the “Error” LED has following functions:

- **Flashes once** at turn-ON of the K8072. Allows you to check if the CPU is functioning.
- **Flashes slowly** when there is no DMX signal reception, no connection between the DMX controller and the K8072, a DMX signal error or no signal compatibility.
- **Flashes rapidly** when the DMX address is positioned on 0 and/or the manual override function has been activated.

JP1: DMX Mode:

- In normal mode (JP1 not mounted) the K8072 will react every time to the DMX value.
- When the error correction mode is activated (JP1 mounted), you will obtain a higher degree of stability which is useful when using some brands of DMX devices; This mode will check the DMX value twice before modifying the relay status. The drawback is that the relay will react slower when modifying the DMX value rapidly.

JP2: Relay HOLD Status:

- Mounted : the relay will deactivate when the DMX connection is disrupted.
- Not mounted : the relay will keep its status when the DMX connection is disrupted.

Manual Override Function:

Exceptionally, the relay must be activated, even when there is no DMX signal (e.g. when testing a light bulb). Proceed as follows:

- Position the DMX address to 0
- Mount jumper JP1
- Switch on the 12V power; the relay will activate regardless of the DMX value.

22. PCB

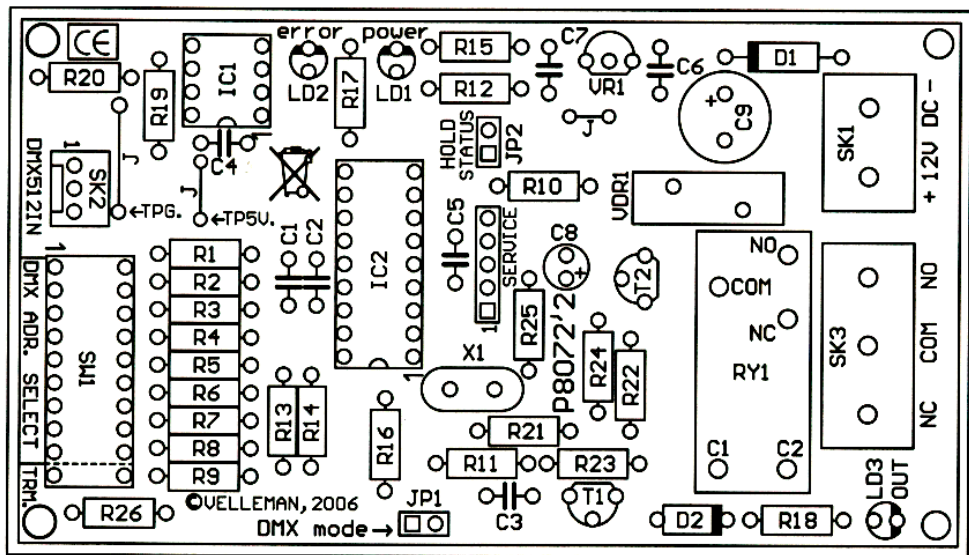

23. Schematic diagram

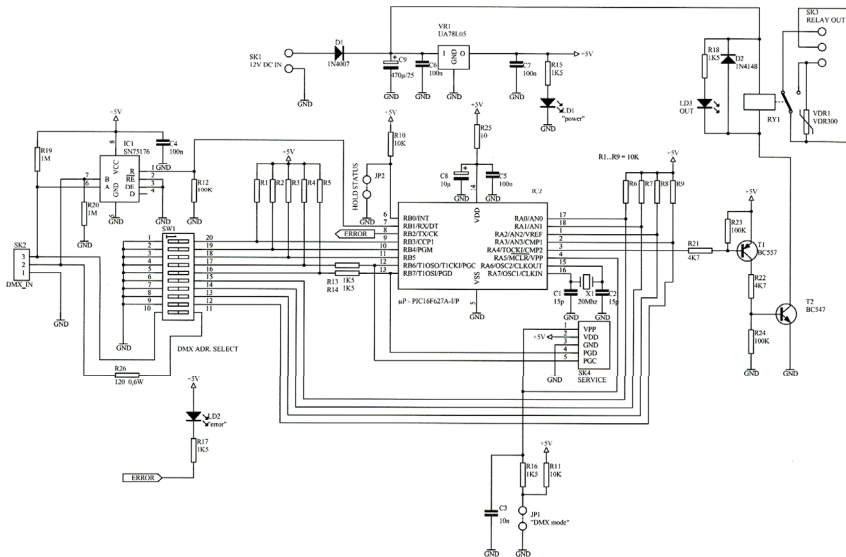

VELBUS
Velleman Home Automation System

ON---ALL---OFF
Sphere Alarm

VELBUS
Velleman Home Automation System

All appliances get intelligent, how about your home?
see our website : www.velbus.be

Modifications and typographical errors reserved
 © Velleman nv.
 H8072IP - 2007 - ED1 (rev.1)

VELLEMAN NV
Legen Heirweg 33, 9890 Gavere
Belgium - Europe

