



TAOGLAS®



Datasheet

Taoglas Reach Series - PCS.46.A

Description:

Reach Low Profile 5G/4G Wideband 400-6000MHz SMD Antenna

Features:

Patent Pending Innovative Low Profile Design

High Efficiency Wideband Antenna, Covering 400 to 6000 MHz

Supporting Bands 31, 72, 74, 87 and 88 between 410MHz to 466MHz

Surface Mount Distribution (SMD) - Supplied on Tape & Reel

Manufactured in an IATF16949 Certified Facility

Dimensions: 67 x 20 x 1.5 mm

RoHS & REACH Compliant

1. Introduction	3
2. Specifications	5
3. Antenna Characteristics	7
4. Radiation Patterns	10
5. Mechanical Drawing	15
6. Antenna Integration Guide	16
7. Packaging	24
<hr/>	
Changelog	25

Taoglas makes no warranties based on the accuracy or completeness of the contents of this document and reserves the right to make changes to specifications and product descriptions at any time without notice. Taoglas reserves all rights to this document and the information contained herein. Reproduction, use or disclosure to third parties without express permission is strictly prohibited.



1. Introduction



The Taoglas Reach Series PCS.46.A is a revolutionary 5G/4G wideband 400-6000MHz SMD Antenna. The PCS.46.A has been designed to cover band 87, 88, 74, 72 and 31 as well all other 5G and 4G bands, including all sub-6GHz deployments across the 400MHz to 6000MHz spectrum. The PCS.46.A has a small footprint of just 67 x 20mm and as it is manufactured from high grade FR4 PCB, it is lightweight, yet robust and it is supplied on tape and reel.

It also covers 3G/ 2G bands to allow for fall-back when 5G/4G is not available. The low profile size of just 1.5mm in height allows for installation where height is at a premium as opposed to other types of products such as ceramic antennas

Typical applications include

- Smart Metering
- Connected Health
- Wearable Technologies
- Payment Terminals

The patent pending design uses printed circuit board material and innovative design techniques to deliver the highest efficiencies at full LTE bands when mounted on the device's main PCB. The PCS.46.A is suitable for lower cost 5G/4G applications, especially the applications include band 87, 88 74, 72 and 31 (410MHz to 466MHz), IoT projects requiring wide bandwidth, etc. It comes supplied on tape and reel to allow it to be mounted via 'pick & place' onto the PCB.

If tuning is required, it can also be tuned specifically depending on device environment. Contact your regional Taoglas customer support team for advice on integrating the PCS.46.A into your device.

1.1 Key Advantages

1. Highest efficiency in small footprint

A comparative antenna to the Reach, for example, metal/ceramic/FPC, would have much-reduced efficiency in this configuration due to their high substrate loss at high frequencies. Very high efficiency antennas are critical to 5G/4G devices ability to deliver the stated data-speed rates of systems such as 5G /4G.

2. Covering Wideband 400-6000MHz

Continuously covering 400MHz – 960MHz plus 1427MHz - 6000MHz with sufficient efficiency in small footprint . Good for full band applications, especially include lower frequency bands, such as 400MHz to 466MHz.

3. Low profile

Many applications, especially lower frequency bands require very large mechanical size to work efficiently, which occupies the usable PCB space. A lot of lower frequency bands application have been abandoned due to antenna size being too big. However the size of PCS.46 is only 67mm X 20mm, and if accounting for the 4mm keep out area, the total area consumed on the PCB is 67mmX20mm = 1340mm² (13.4cm²). It opens a broad door for lower band applications, because the antenna is relatively very small with high efficiency.

4. Adaptable

The high radiation efficiency of the Reach over its entire operating bandwidth means that the total efficiency is only limited by the impedance mismatch loss. As a result, this antenna has been optimized via a matching network to 400MHz – 960MHz and 1400MHz – 6000MHz with the typical efficiencies of 50% and 65% respectively.

5. More resistant to detuning compared to other antenna integrations

If tuning is required it can be tuned for the device environment using a matching circuit, or other techniques on the main PCB itself. There is no need for new tooling, thereby saving money if customization is required.

6. Surface Mount Device (SMD)

Direct mount, 'on-board' antennas save on labor, cable and connector costs, lead to higher integration yield rates and reduce losses in transmission.

7. Minimum Transmission and Reception Losses

These are kept to an absolute minimum resulting in much improved OTA (over the air), i.e. TRP (Total Radiated Power) / TIS (Total Isotropic Radiation), device performance compared to similar efficiency cable and connector antenna solutions. This means it is an ideal antenna to be used for devices that This means it is an ideal antenna to be used for devices that need to pass for example USA carrier network approvals.

2. Specifications

Electrical								
Band	Frequency (MHz)	Efficiency (%)	Average Gain	Peak Gain (dBi)	Impedance	Max Input	Polarization	Radiation Pattern
4G/3G Band 31,72,73,87,88,126	400~480	23	-6.5	-0.5	50 Ω	20W	Linear	Omni-Directional
5G NR/4G Band 71	617~698	58	-2.4	1.6				
4G/3G Band 12,13,14,17,28,29	698~806	64	-1.9	2.6				
4G/3G/NB-IoT/Cat M Band 5,8,18,19,20,26,27	824~960	36	-4.3	2.5				
5G NR/4G Band 21,32,74,75,76	1427~1518	60	-2.3	3.6				
4G/3G Band 1,2,3,4,9,23,25,35,39,66	1710~2200	80	-1.0	5.6				
4G/3G Band 7,30,38,40,41	2300~2690	86	-0.7	5.6				
5G NR/4G Band 22,42,48,77,78,79	3300~5000	58	-2.4	4.8				
LTE5200/ Wi-Fi 5800	5150~5925	65	-1.9	4.5				

The PCS.46.A antenna performance was measured on a 190 x 67 mm ground plane

Mechanical	
Dimensions	67mm x 20mm x 1.5mm
Weight	7g
Material	FR4
Termination	Solder Pad
EVB Connector	SMA-Female
Environmental	
Operation Temperature	-40°C to 85°C
Storage Temperature	-40°C to 105°C
Relative Humidity	Non-condensing 65°C 95% RH
RoHS & REACH Compliant	Yes

5G/4G Bands			
Band Number	5GNR / FR1 / LTE / LTE-Advanced / WCDMA / HSPA / HSPA+ / TD-SCDMA		
	Uplink	Downlink	Covered
1	UL: 1920 to 1980	DL: 2110 to 2170	✓
2	UL: 1850 to 1910	DL: 1930 to 1990	✓
3	UL: 1710 to 1785	DL: 1805 to 1880	✓
4	UL: 1710 to 1755	DL: 2110 to 2155	✓
5	UL: 824 to 849	DL: 869 to 894	✓
7	UL: 2500 to 2570	DL: 2620 to 2690	✓
8	UL: 880 to 915	DL: 925 to 960	✓
9	UL: 1749.9 to 1784.9	DL: 1844.9 to 1879.9	✓
11	UL: 1427.9 to 1447.9	DL: 1475.9 to 1495.9	✓
12	UL: 699 to 716	DL: 729 to 746	✓
13	UL: 777 to 787	DL: 746 to 756	✓
14	UL: 788 to 798	DL: 758 to 768	✓
17	UL: 704 to 716	DL: 734 to 746	✓
18	UL: 815 to 830	DL: 860 to 875	✓
19	UL: 830 to 845	DL: 875 to 890	✓
20	UL: 832 to 862	DL: 791 to 821	✓
21	UL: 1447.9 to 1462.9	DL: 1495.9 to 1510.9	✓
22	UL: 3410 to 3490	DL: 3510 to 3590	✓
23	UL: 2000 to 2020	DL: 2180 to 2200	✓
24	UL: 1625.5 to 1660.5	DL: 1525 to 1559	✓
25	UL: 1850 to 1915	DL: 1930 to 1995	✓
26	UL: 814 to 849	DL: 859 to 894	✓
27	UL: 807 to 824	DL: 852 to 869	✓
28	UL: 703 to 748	DL: 758 to 803	✓
29	UL: -	DL: 717 to 728	✓
30	UL: 2305 to 2315	DL: 2350 to 2360	✓
31	UL: 452.5 to 457.5	DL: 462.5 to 467.5	✓
32	UL: -	DL: 1452 – 1496	✓
35		1850 to 1910	✓
38		2570 to 2620	✓
39		1880 to 1920	✓
40		2300 to 2400	✓
41		2496 to 2690	✓
42		3400 to 3600	✓
43		3600 to 3800	✓
48		3550 to 3700	✓
66	UL: 1710 to 1780	DL: 2110 to 2200	✓
71		617 to 698	✓
72	UL: 451 to 456	DL: 461 to 466	✓
73	UL: 450 to 455	DL: 460 to 465	✓
74/75/76		1427 to 1518	✓
77		3300 to 4200	✓
78		3300 to 3800	✓
79		4400 to 5000	✓
87	UL: 410 to 415	DL: 420 to 425	✓
88	UL: 412 to 417	DL: 422 to 427	✓

3. Antenna Characteristics

3.1 Test Setup

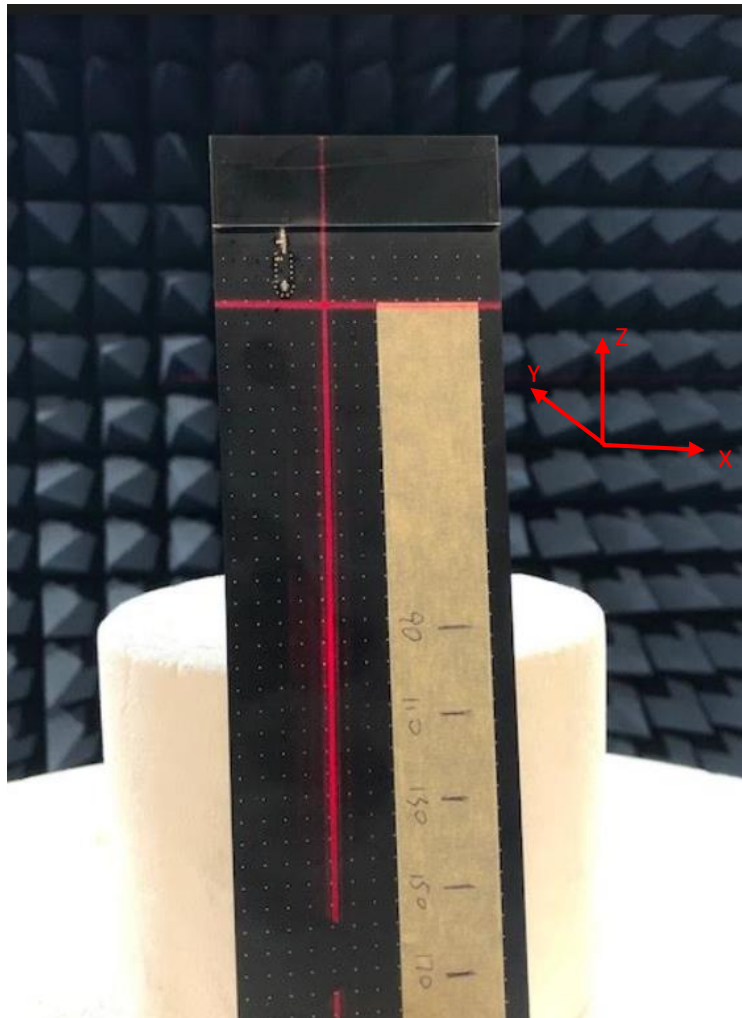

On Evaluation Board

3.2 Return Loss

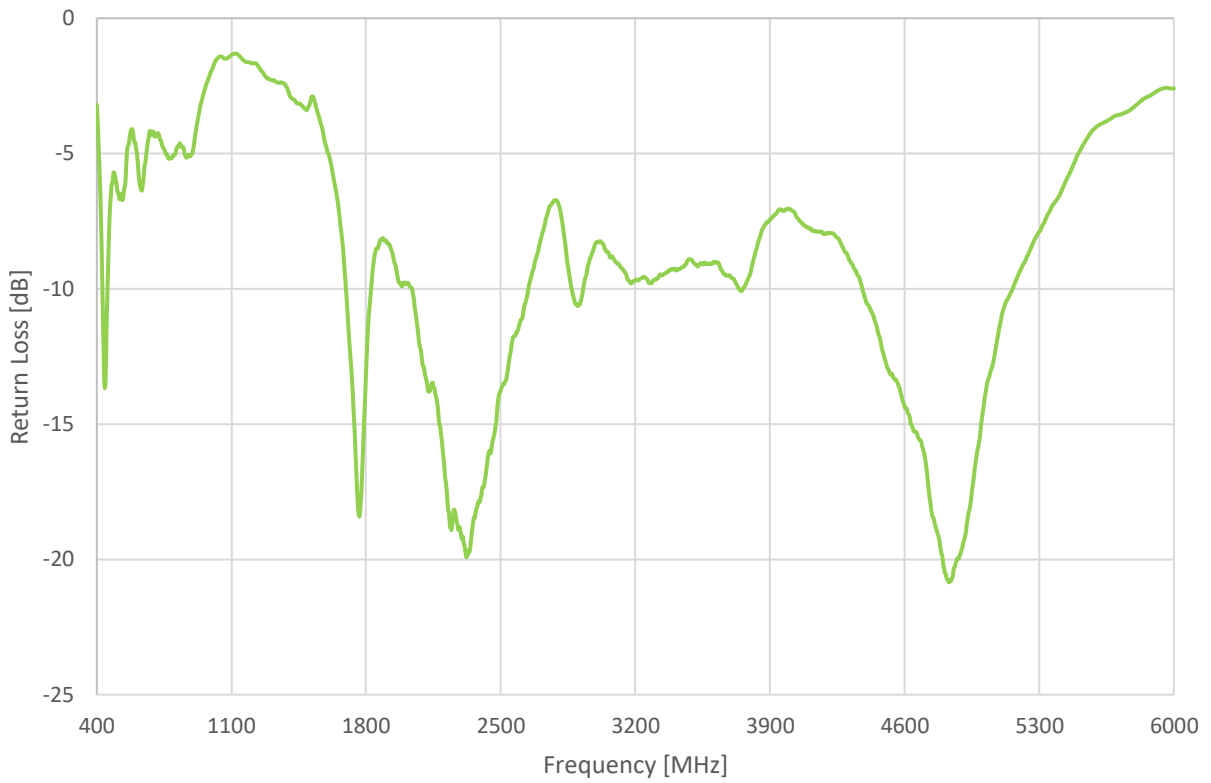

3.3 Efficiency

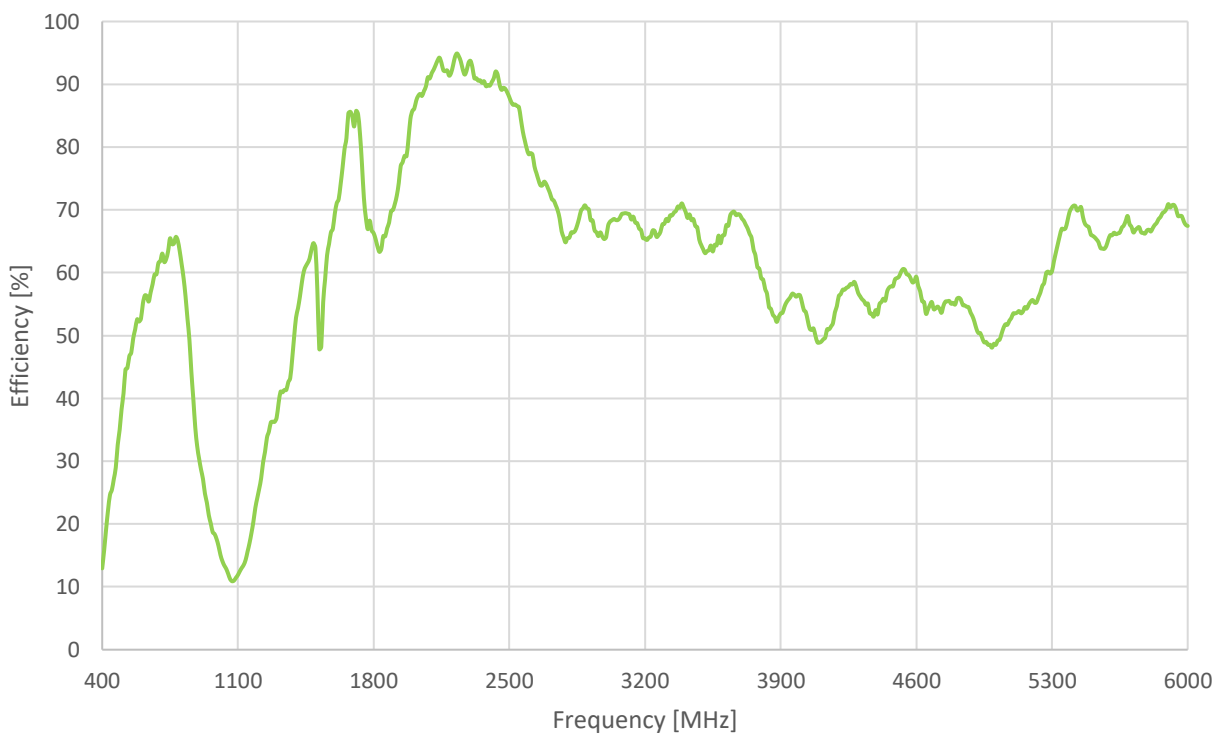

3.4 Peak Gain

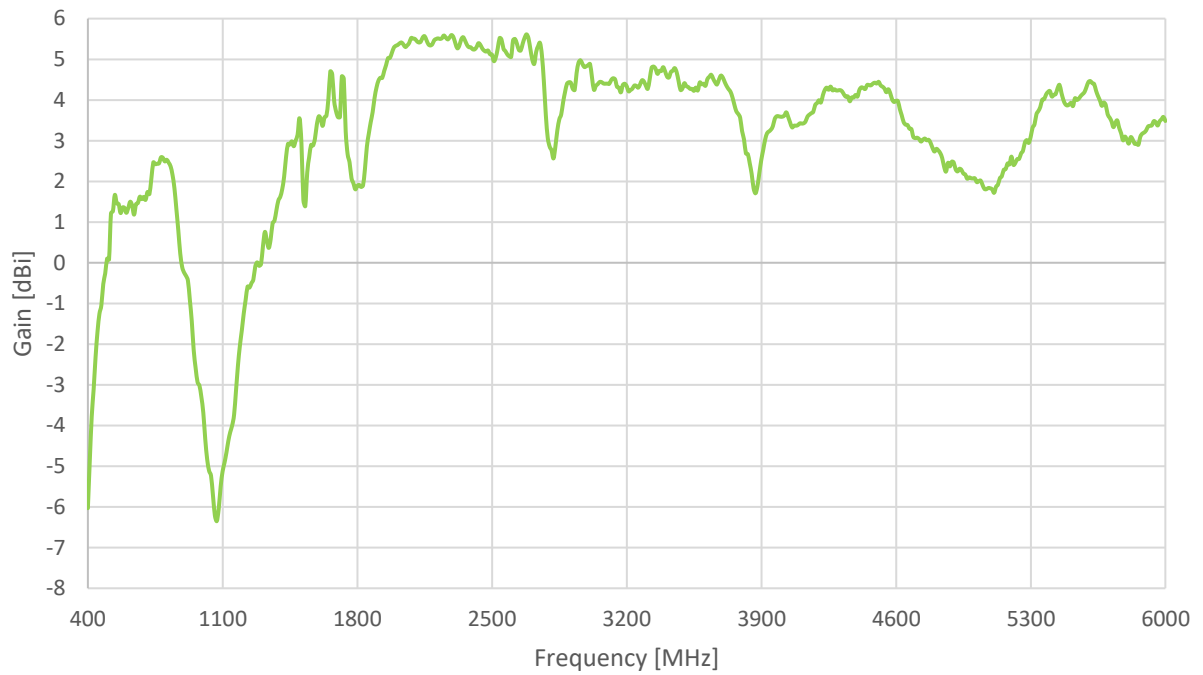

3.5 Average Gain

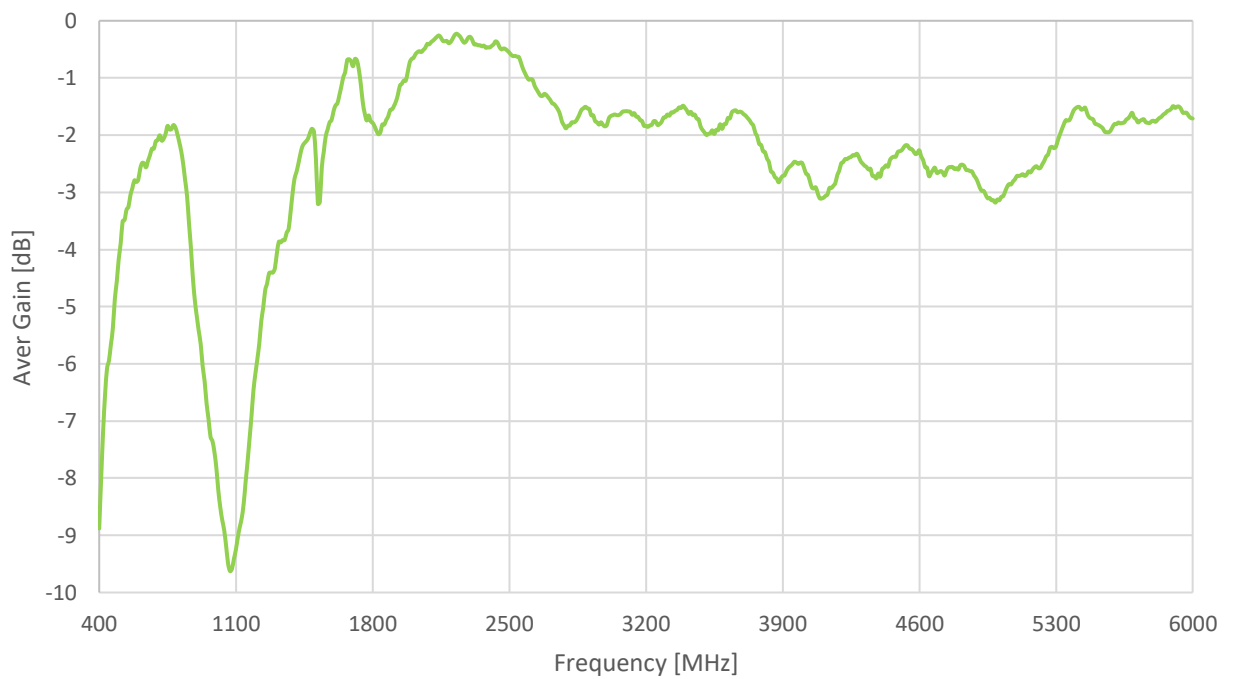

4. Radiation Patterns

4.1 800MHz 3D and 2D Radiation Patterns

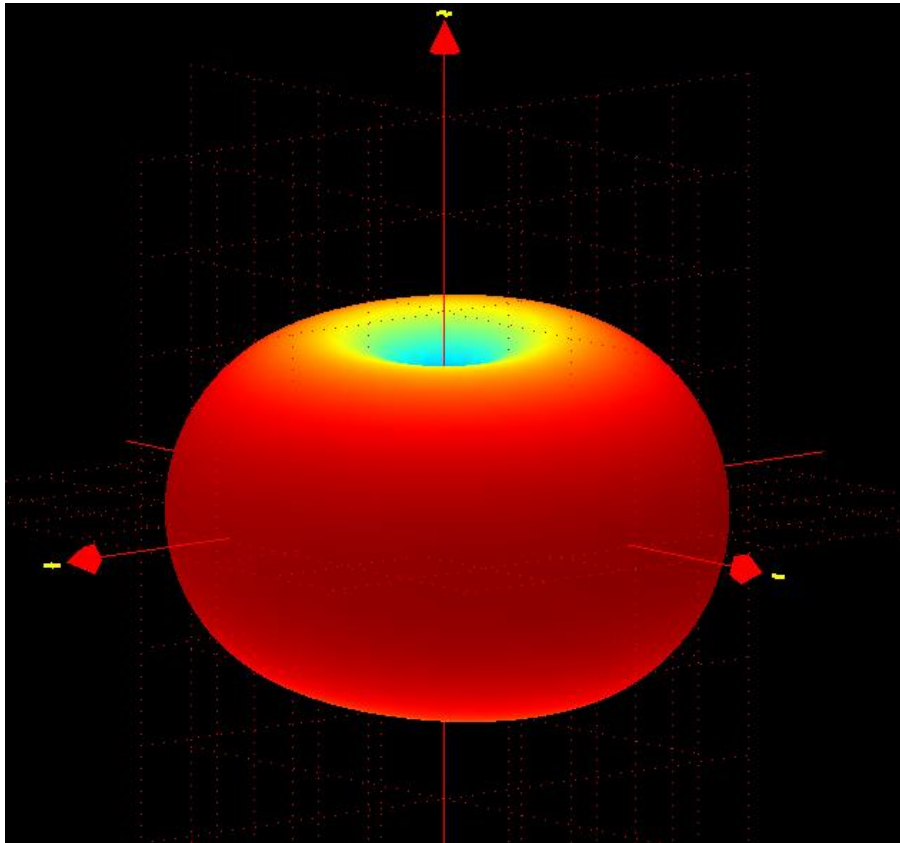

XY Plane

XZ Plane

YZ Plane

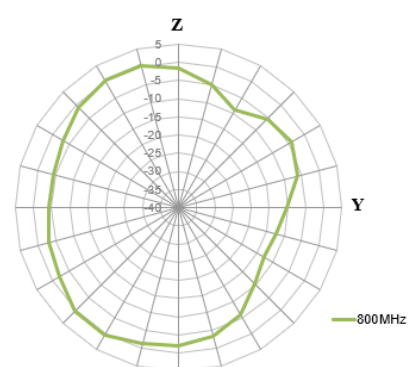
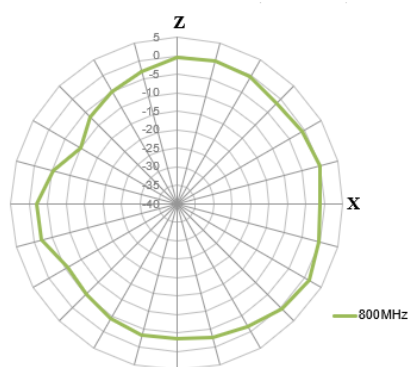
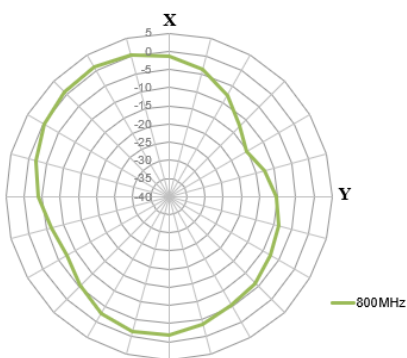

1470MHz

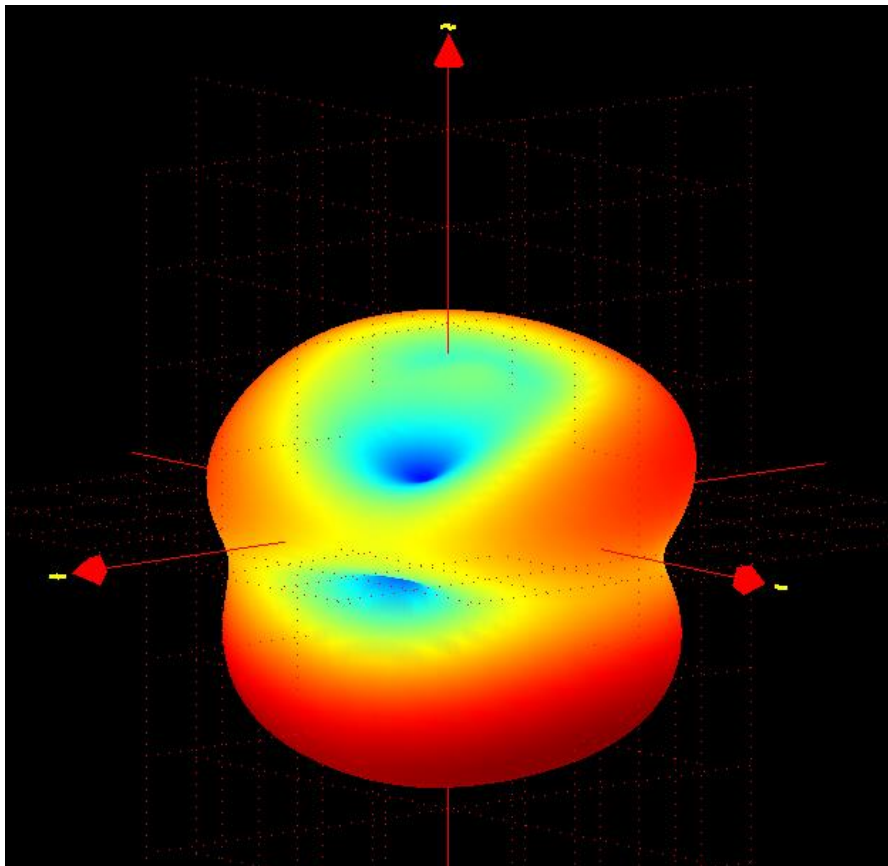

XY Plane

XZ Plane

YZ Plane

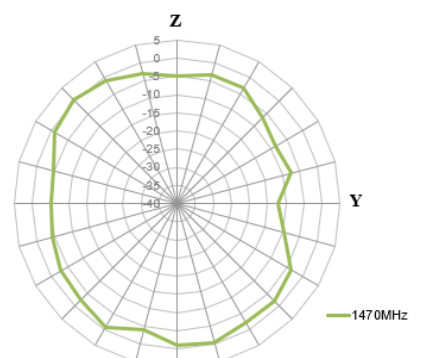
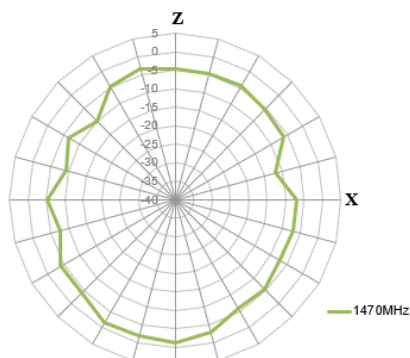
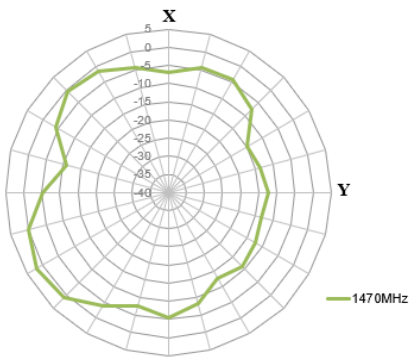

1910MHz

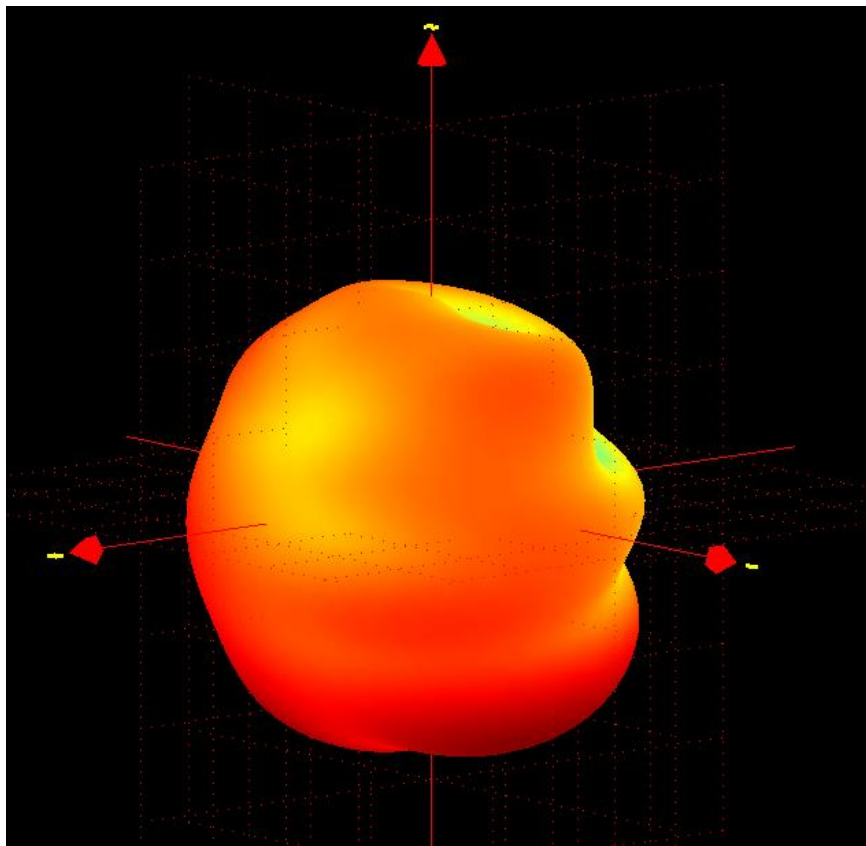

XY Plane

XZ Plane

YZ Plane

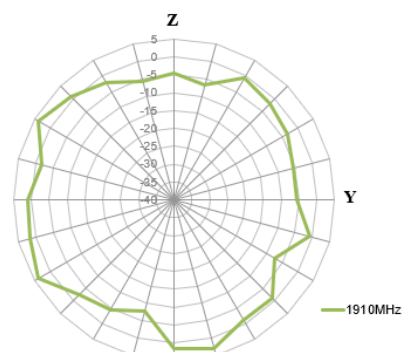
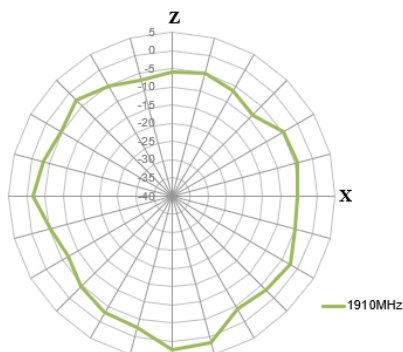
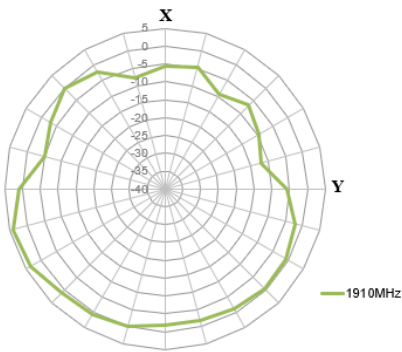

2550MHz

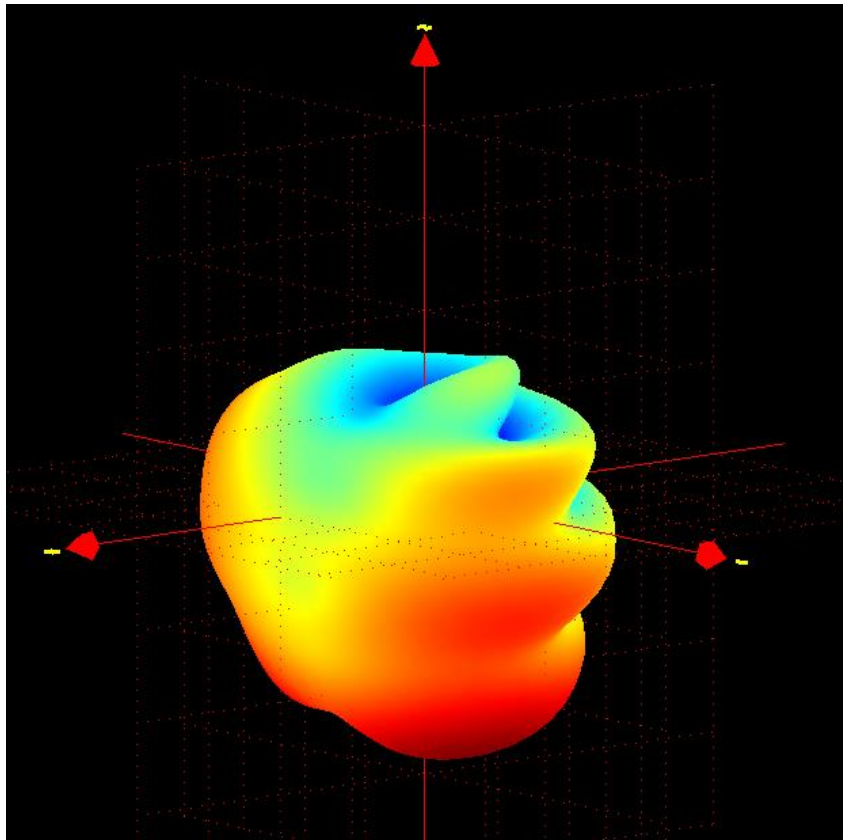

XY Plane

XZ Plane

YZ Plane

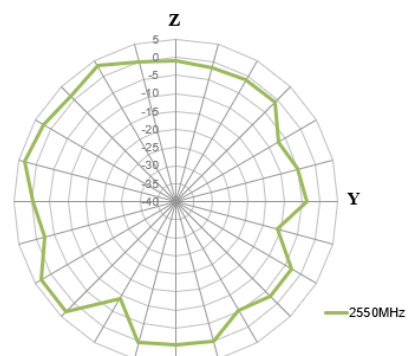
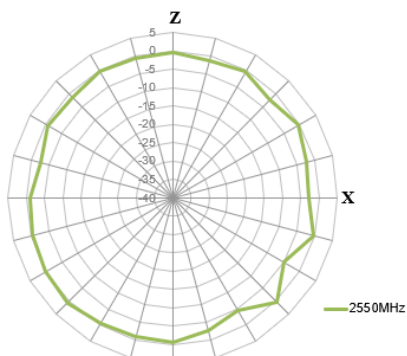
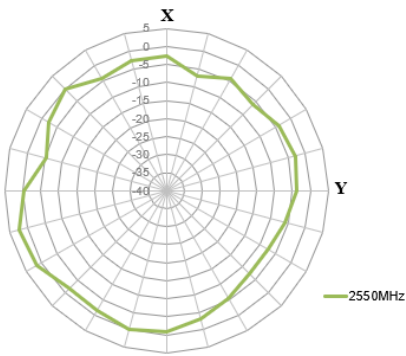

4500MHz

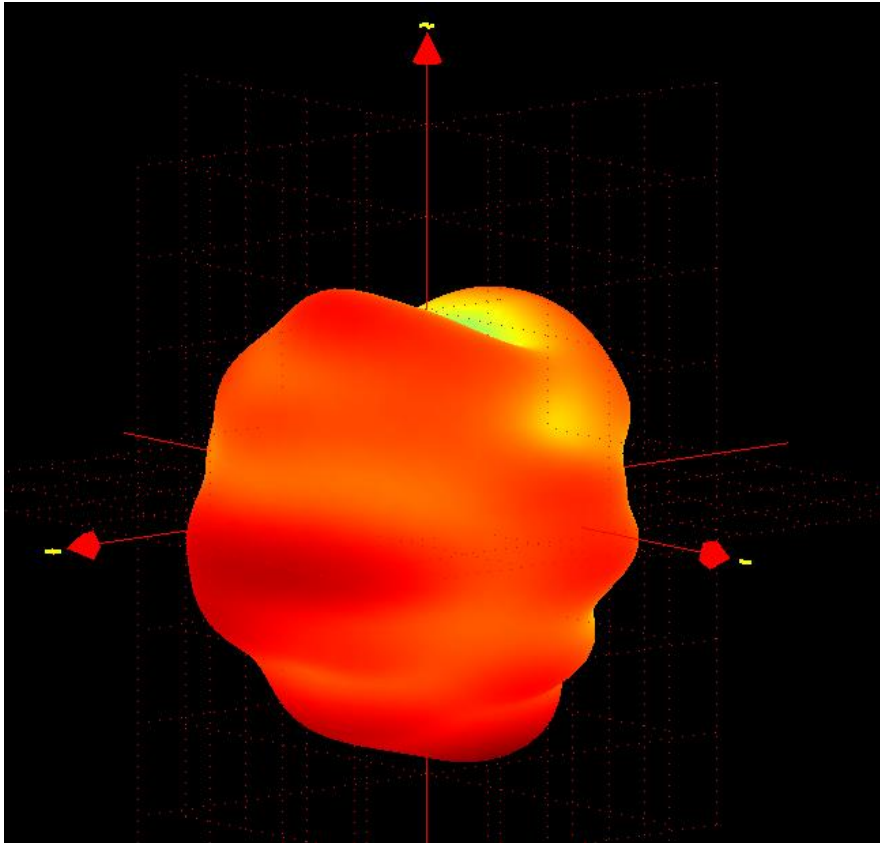

XY Plane

XZ Plane

YZ Plane

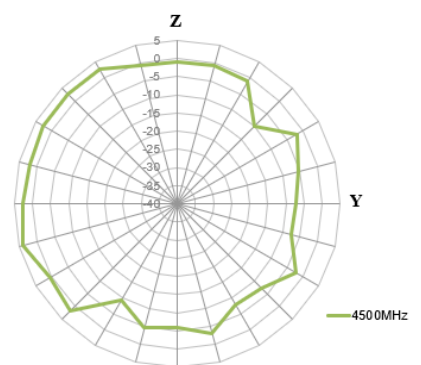
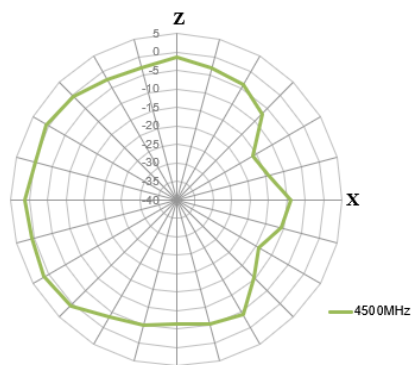
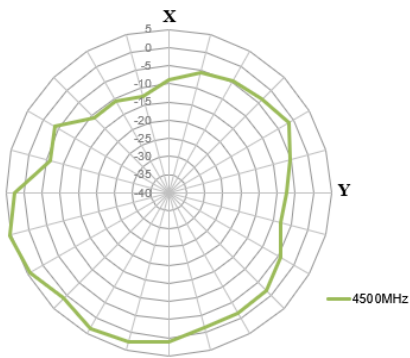

5. Mechanical Drawing (Units: mm)

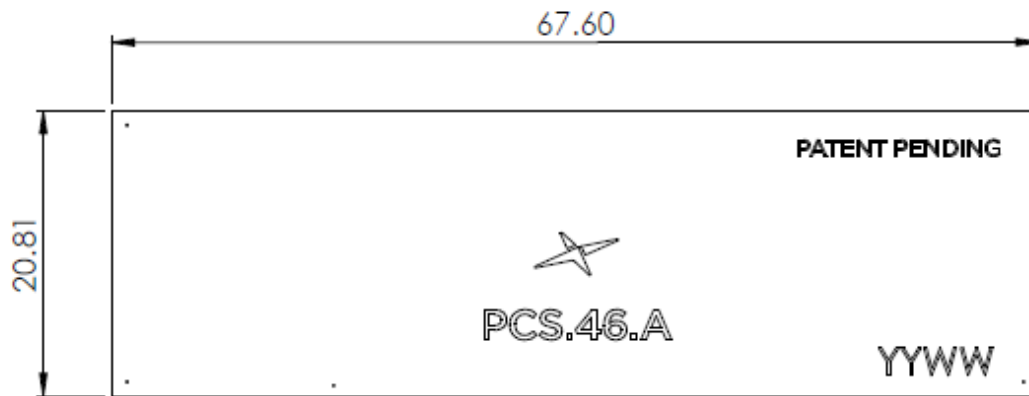

TOP VIEW

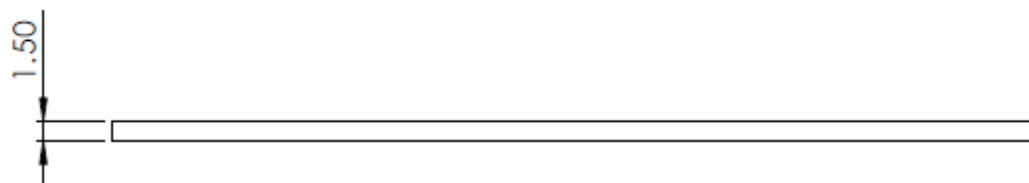

SIDE VIEW

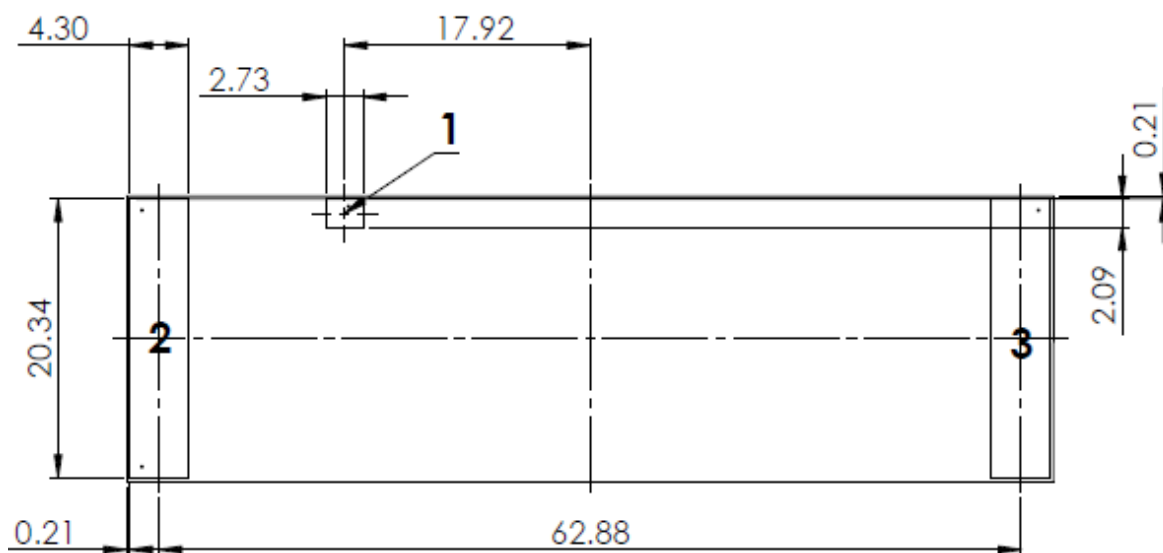

BOTTOM VIEW

6. Antenna Integration Guide

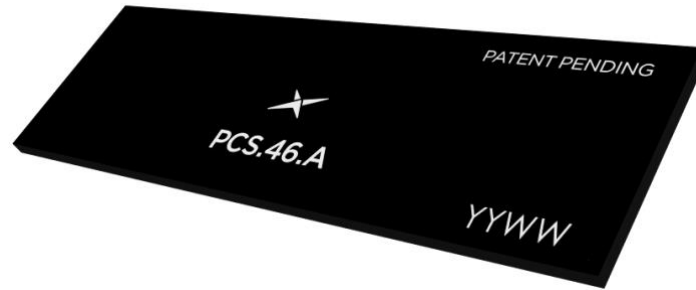

6.1 Schematic Symbol and Pin Definition

The circuit symbol for the antenna is shown below. The antenna has 3 pins with only one pin (Pin 1) as functional. Pins 3 and 4 are for mechanical strength.

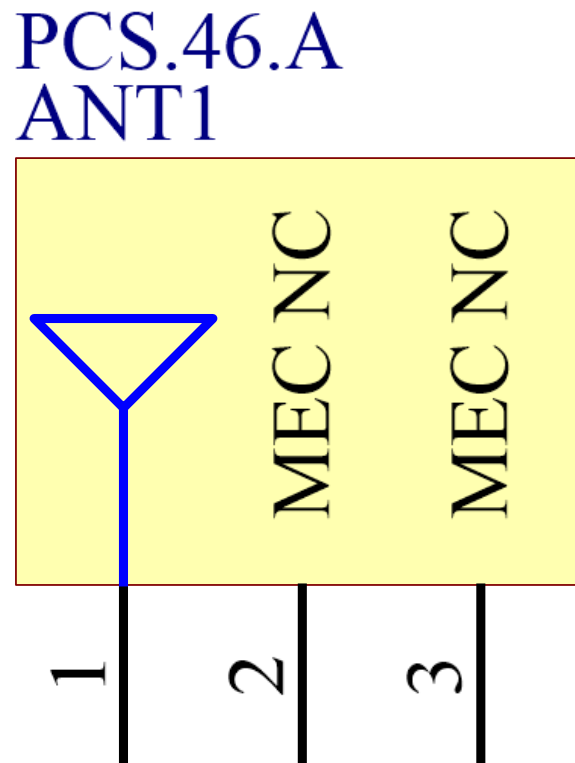

Pin	Description
1	RF Feed
2,3	Mechanical, Not Connected

6.2 Antenna Integration

Whatever the size of the PCB, the antenna should ideally be placed on the PCB's shortest side, to take advantage of the ground plane. Optimized matching components can be placed as shown.

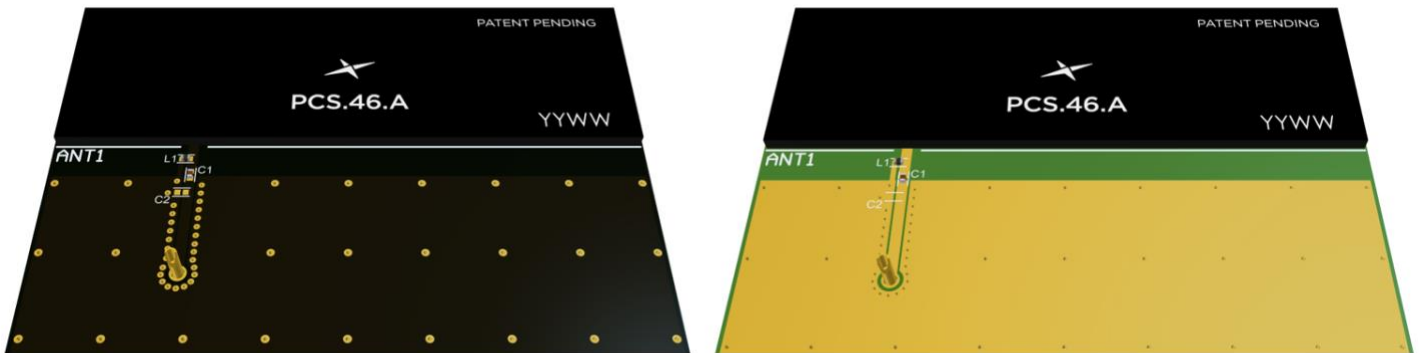

6.3 PCB Layout

The footprint and clearance on the PCB must meet the antenna specification. An example of the PCB layout shows the antenna footprint with clearance. Note the placement of the optimized components.

L1 is positioned outside the ground plane and C1 is sitting across the ground plane and the copper clearance area. C2 is optional as a component but it is recommended to include these pads in case they are needed.

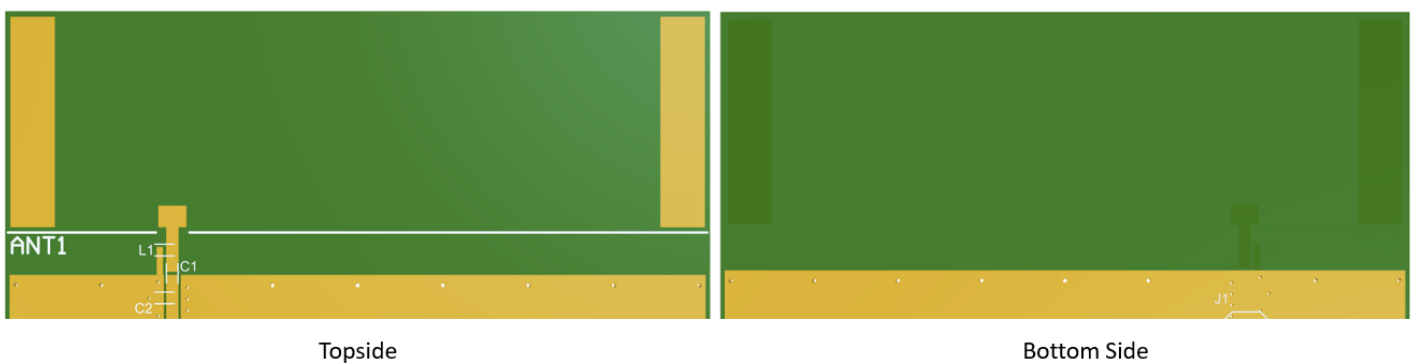

6.4 PCB Clearance

Below shows the antenna footprint and clearance through ALL layers on the PCB. Only the antenna pads and connections to feed and GND are present within this clearance area (marked RED). The clearance area extends to 4.61mm from the antenna mechanical pads to the ground area. This clearance area includes the bottom side and ALL internal layers on the PCB.



Topside



Bottom Side

6.5 Evaluation Board

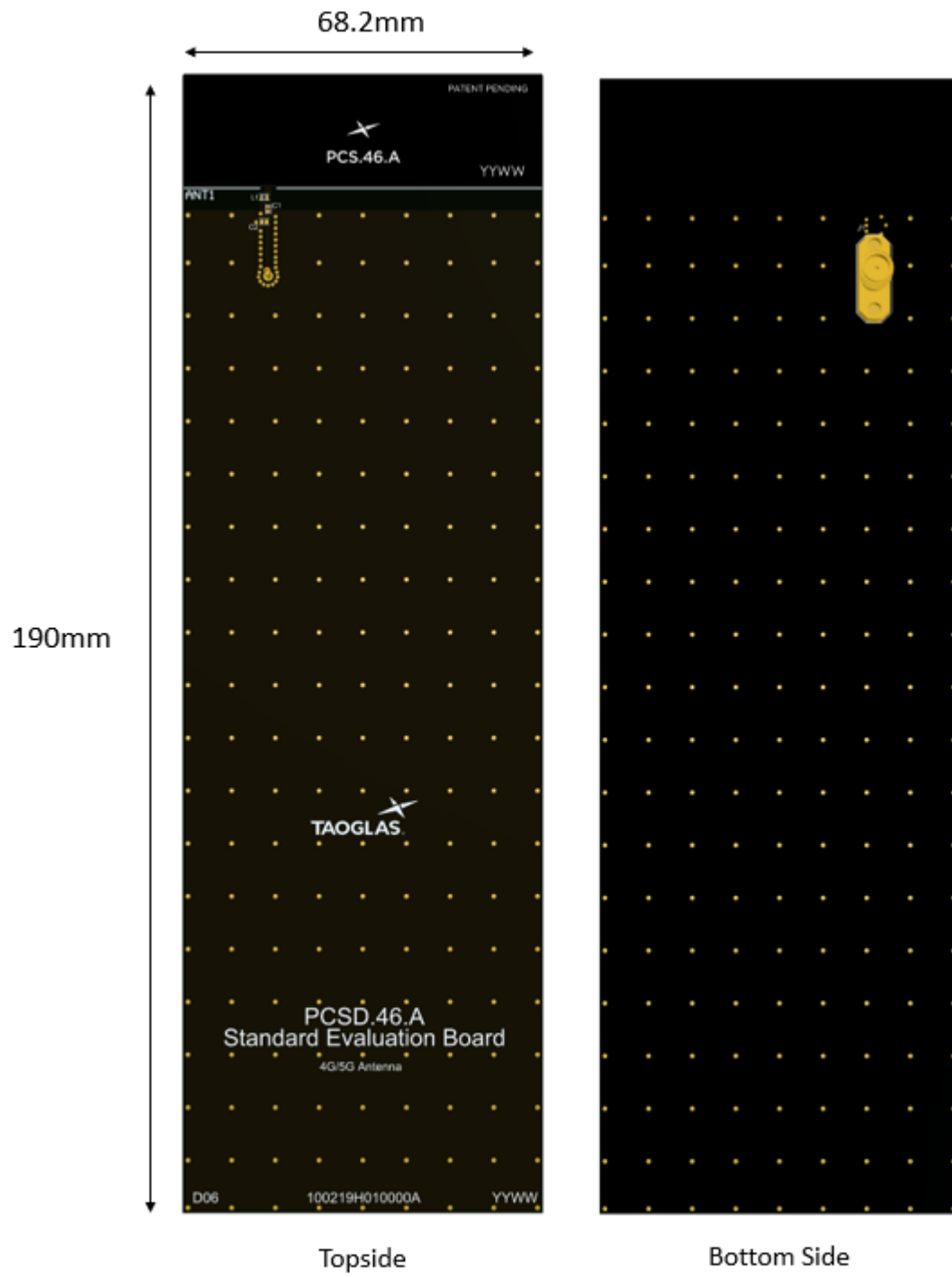

6.6 Evaluation Board Ground Plane Length



6.7 Evaluation Board Matching Circuit

A matching component (L1) in parallel with the PCS.46.A is required for the antenna to have optimal performance on the evaluation board, located outside of the ground plane in the space specified in the above images. Additional matching components may be necessary for your device, so we recommend incorporating extra component footprints, forming a “pi” network, between the cellular module and the edge of the ground plane.

Designator	Type	Value	Manufacturer	Manufacturer Part Number
L1	Inductor	18nH	TDK	MLK1005S18NJT000
C1	Capacitor	4pF	MURATA	GRM1555C1H4R0CA01D
C2	Capacitor	Not Fitted	-	-

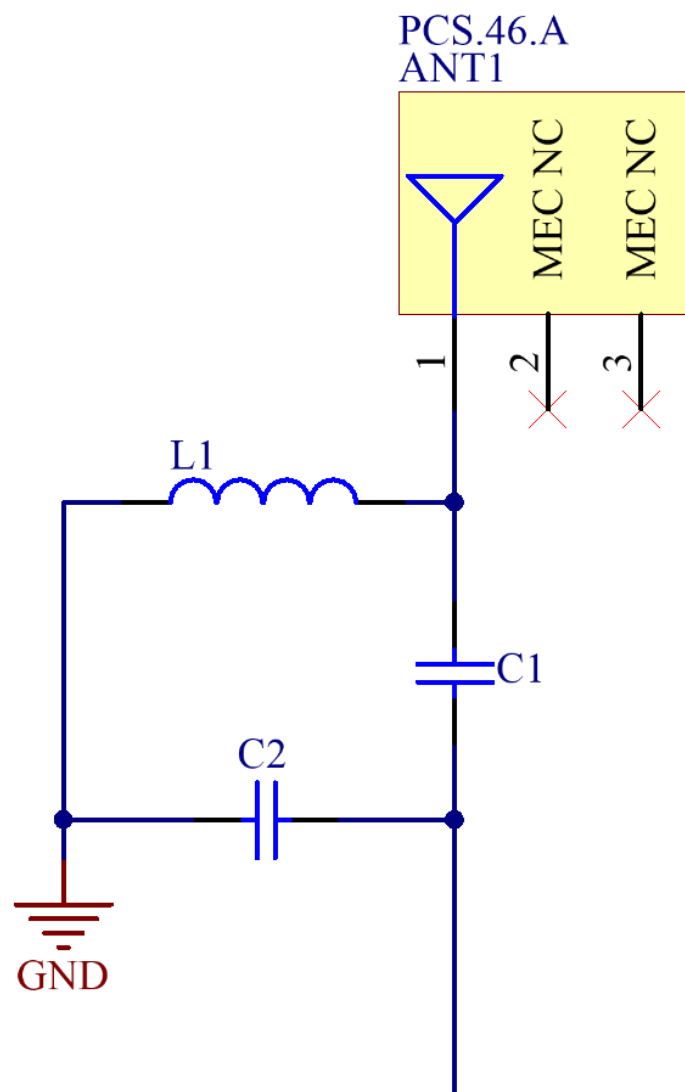

6.8 Footprint

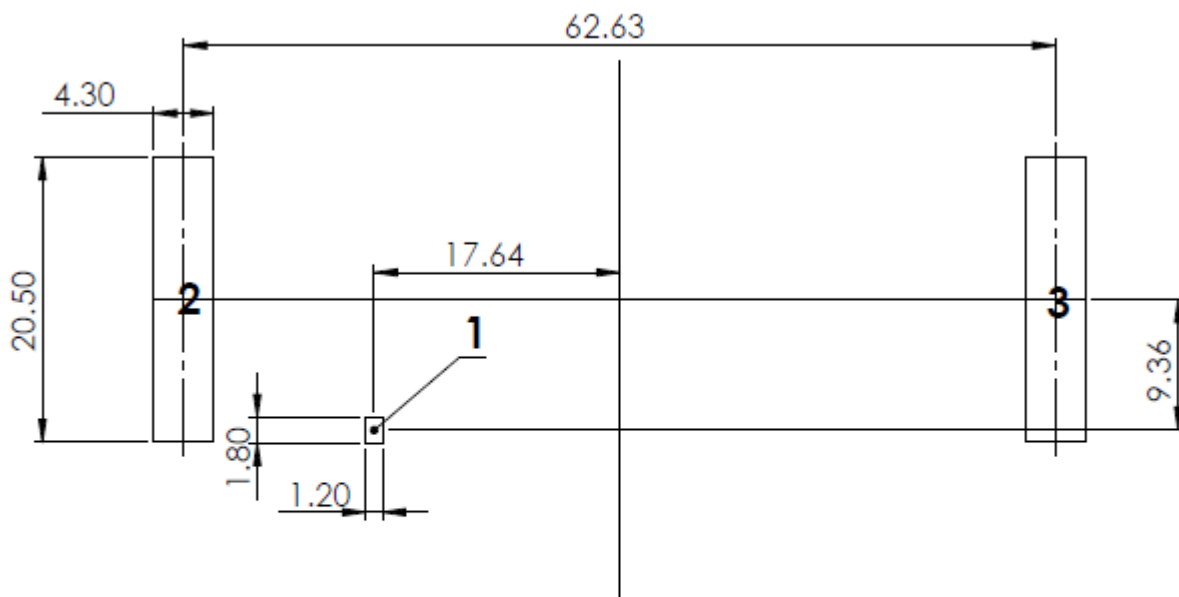

PCB FOOTPRINT

<u>PIN:</u>	<u>DESCRIPTION:</u>
1	FEED (50 OHM)
2,3	MECHANICAL (NOT CONNECTED)

7. Packaging

500 pcs PCS.46.A reel
 Dimensions - 330*330*80mm
 Weight - 5.8Kg



500 pcs PCS.46.A / 1 Reel in small box
 Dimensions - 335*335*85mm
 Weight - 6.5Kg

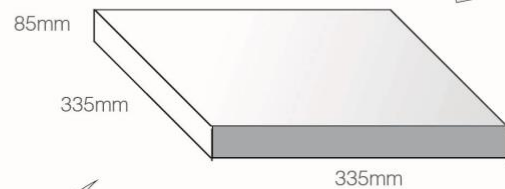

3 reels, 1500 pcs in one carton
 Carton Dimensions - 370*360*300mm
 Weight - 19.8Kg

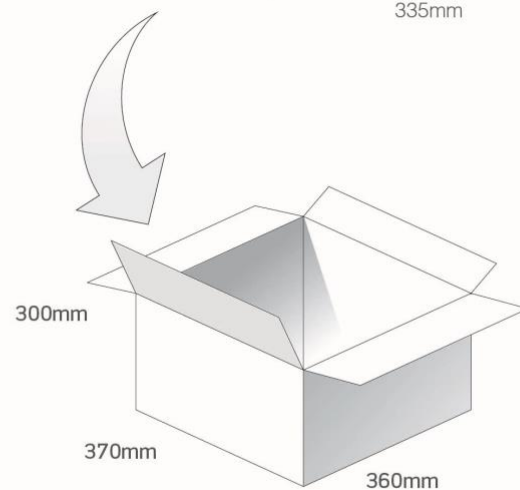

Changelog for the datasheet

SPE-19-8-145 – PCS.46.A

Revision: C (Current Version)

Date:	2022-03-23
Notes:	Updated image and Packaging
Author:	Gary West

Previous Revisions

Revision: B

Date:	2022-02-07
Notes:	Updated Integration Guide
Author:	Gary West

Revision: A (Original Release)

Date:	2021-12-22
Notes:	Initial Datasheet Release
Author:	Gary West



www.taoglas.com

