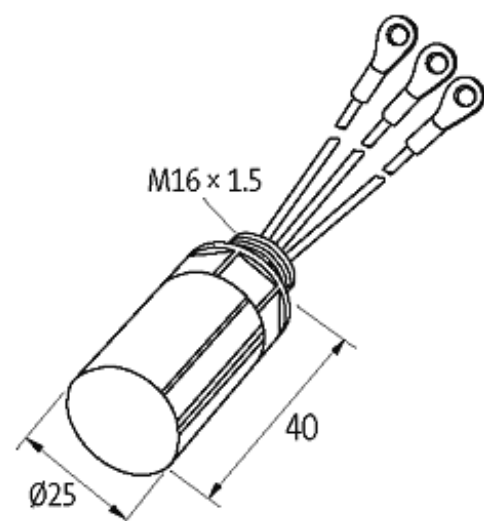

MOTOR SUPPRESSOR

Varistor, 3x400VAC/4kW

3 × 400 V AC
VDR
isolated M6

Suppressors for other voltages, frequencies, and motor ratings available on request. Do not use RC motor suppressors with frequency inverters.

[Link to Product](#)**Illustration**

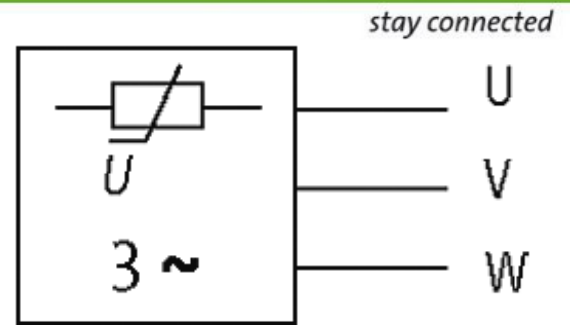

VDR

Product may differ from Image

Approvals



Technical Data

Material	Flame retardant plastic acc. to (UL 94)
Potting compound	2-component epoxy
Frequency	10...400 Hz
Ring terminals	isolated M6

General data

Connection	approx. 100 mm, single cores 0.5 mm ²
Temperature range	-20...+60 °C
Dimensions H × W × D	25×25×40 mm

Commercial data

country of origin	CZ
customs tariff number	85363010
minimum order quantity	1