

## IR Receiver Modules for Remote Control Systems

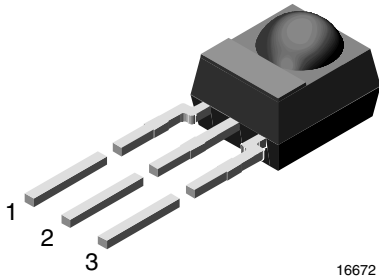

16672

### MECHANICAL DATA

#### Pinning for TSOP348.., TSOP344..:

 1 = OUT, 2 = GND, 3 =  $V_S$ 

#### Pinning for TSOP322.., TSOP324..:

 1 = OUT, 2 =  $V_S$ , 3 = GND

### FEATURES

- Very low supply current
- Photo detector and preamplifier in one package
- Internal filter for PCM frequency
- Supply voltage: 2.5 V to 5.5 V
- Improved immunity against ambient light
- Insensitive to supply voltage ripple and noise
- Material categorization:  
for definitions of compliance please see [www.vishay.com/doc?99912](http://www.vishay.com/doc?99912)

**RoHS**  
 COMPLIANT  
 HALOGEN  
**FREE**  
**GREEN**  
(5-2008)

### DESCRIPTION

The TSOP322.., TSOP348.., TSOP324.. and TSOP344.. series are miniaturized IR receiver modules for infrared remote control systems. A PIN diode and a preamplifier are assembled on lead frame, the epoxy package contains an IR filter.

The demodulated output signal can be directly connected to a microprocessor for decoding.

The TSOP324.., TSOP344.. series devices are optimized to suppress almost all spurious pulses from energy saving lamps like CFLs. The AGC4 used in the TSOP324.., TSOP344.. may suppress some data signals. The TSOP322.., TSOP348.. series are provided primarily for compatibility with old AGC2 designs. New designs should prefer the TSOP324.., TSOP344.. series containing the newer AGC4.

These components have not been qualified according to automotive specifications.

| PARTS TABLE              |   |  |                             |  |                                |
|--------------------------|---|--|-----------------------------|--|--------------------------------|
| AGC                      |   | LEGACY, FOR<br>LONG BURST REMOTE CONTROLS (AGC2) |                             | RECOMMENDED FOR<br>LONG BURST CODES (AGC4) |                                |
| Carrier<br>frequency     | 30 kHz  | TSOP34830  | TSOP32230                   | TSOP34430                                  | TSOP32430                      |
|                          | 33 kHz  | TSOP34833  | TSOP32233                   | TSOP34433                                  | TSOP32433                      |
|                          | 36 kHz  | TSOP34836  | TSOP32236                   | TSOP34436 <sup>(1)(2)(3)</sup>             | TSOP32436 <sup>(1)(2)(3)</sup> |
|                          | 38 kHz  | TSOP34838  | TSOP32238                   | TSOP34438 <sup>(4)(5)</sup>                | TSOP32438 <sup>(4)(5)</sup>    |
|                          | 40 kHz  | TSOP34840  | TSOP32240                   | TSOP34440                                  | TSOP32440                      |
|                          | 56 kHz  | TSOP34856  | TSOP32256                   | TSOP34456 <sup>(6)(7)</sup>                | TSOP32456 <sup>(6)(7)</sup>    |
| Package                  | Mold  |  |                             |  |                                |
| Pinning                  | 1 = OUT, 2 = GND, 3 = $V_S$   | 1 = OUT, 2 = $V_S$ , 3 = GND                     | 1 = OUT, 2 = GND, 3 = $V_S$ | 1 = OUT, 2 = $V_S$ , 3 = GND               |                                |
| Dimensions (mm)          | 6.0 W x 6.95 H x 5.6 D  |  |                             |  |                                |
| Mounting                 | Leaded  |  |                             |  |                                |
| Application              | Remote control  |  |                             |  |                                |
| Best remote control code | <sup>(1)</sup> RC-5 <sup>(2)</sup> RC-6 <sup>(3)</sup> Panasonic <sup>(4)</sup> NEC <sup>(5)</sup> Sharp <sup>(6)</sup> r-step <sup>(7)</sup> Thomson RCA |  |                             |  |                                |

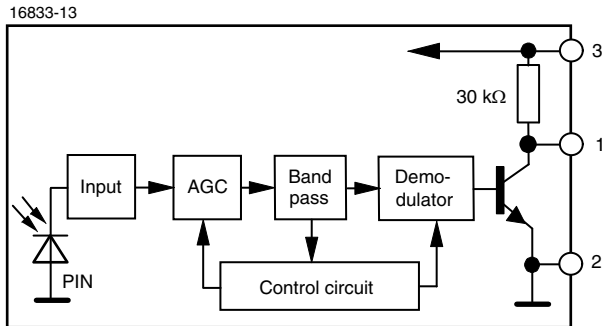
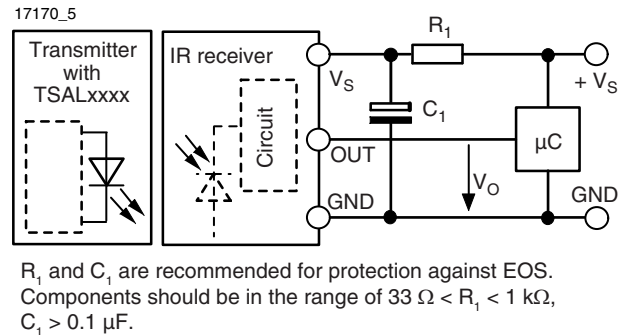
**BLOCK DIAGRAM**

**APPLICATION CIRCUIT**

**ABSOLUTE MAXIMUM RATINGS**

| PARAMETER                   | TEST CONDITION                                  | SYMBOL           | VALUE                 | UNIT |
|-----------------------------|---|------------------|-----------------------|------|
| Supply voltage              |   | $V_S$            | -0.3 to +6            | V    |
| Supply current              |   | $I_S$            | 3                     | mA   |
| Output voltage              |   | $V_O$            | -0.3 to $(V_S + 0.3)$ | V    |
| Output current              |   | $I_O$            | 5                     | mA   |
| Junction temperature        |   | $T_j$            | 100                   | °C   |
| Storage temperature range   |   | $T_{\text{stg}}$ | -25 to +85            | °C   |
| Operating temperature range |   | $T_{\text{amb}}$ | -25 to +85            | °C   |
| Power consumption           | $T_{\text{amb}} \leq 85 \text{ }^\circ\text{C}$ | $P_{\text{tot}}$ | 10                    | mW   |
| Soldering temperature       | $t \leq 10 \text{ s}$ , 1 mm from case          | $T_{\text{sd}}$  | 260                   | °C   |

**Note**

- Stresses beyond those listed under “Absolute Maximum Ratings” may cause permanent damage to the device. This is a stress rating only and functional operation of the device at these or any other conditions beyond those indicated in the operational sections of this specification is not implied. Exposure to absolute maximum rating conditions for extended periods may affect the device reliability.

**ELECTRICAL AND OPTICAL CHARACTERISTICS** ( $T_{\text{amb}} = 25 \text{ }^\circ\text{C}$ , unless otherwise specified)

| PARAMETER             | TEST CONDITION  | SYMBOL             | MIN. | TYP.     | MAX. | UNIT            |
|-----------------------|---|--------------------|------|----------|------|-----------------|
| Supply current        | $E_v = 0$ , $V_S = 3.3 \text{ V}$   | $I_{\text{SD}}$    | 0.27 | 0.35     | 0.45 | mA              |
|                       | $E_v = 40 \text{ klx}$ , sunlight   | $I_{\text{SH}}$    | -    | 0.45     | -    | mA              |
| Supply voltage        |   | $V_S$              | 2.5  | -        | 5.5  | V               |
| Transmission distance | $E_v = 0$ , test signal see fig. 1, IR diode TSAL6200, $I_F = 150 \text{ mA}$                                   | $d$                | -    | 45       | -    | m               |
| Output voltage low    | $I_{\text{OSL}} = 0.5 \text{ mA}$ , $E_e = 0.7 \text{ mW/m}^2$ , test signal see fig. 1                         | $V_{\text{OSL}}$   | -    | -        | 100  | mV              |
| Minimum irradiance    | Pulse width tolerance: $t_{\text{pi}} - 5/f_0 < t_{\text{po}} < t_{\text{pi}} + 6/f_0$ , test signal see fig. 1 | $E_e \text{ min.}$ | -    | 0.08     | 0.15 | $\text{mW/m}^2$ |
| Maximum irradiance    | $t_{\text{pi}} - 5/f_0 < t_{\text{po}} < t_{\text{pi}} + 6/f_0$ , test signal see fig. 1                        | $E_e \text{ max.}$ | 30   | -        | -    | $\text{W/m}^2$  |
| Directivity           | Angle of half transmission distance   | $\phi_{1/2}$       | -    | $\pm 45$ | -    | deg             |

## TYPICAL CHARACTERISTICS (T<sub>amb</sub> = 25 °C, unless otherwise specified)

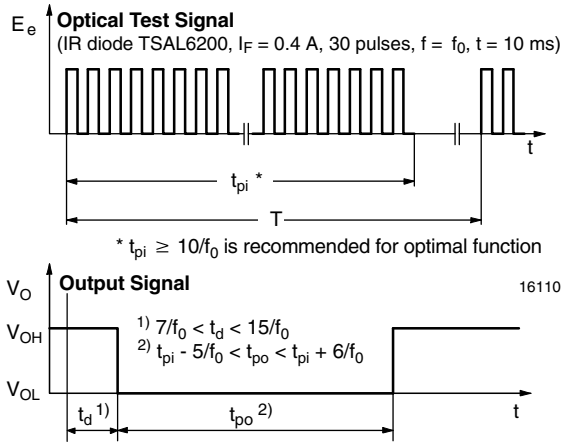

Fig. 1 - Output Active Low

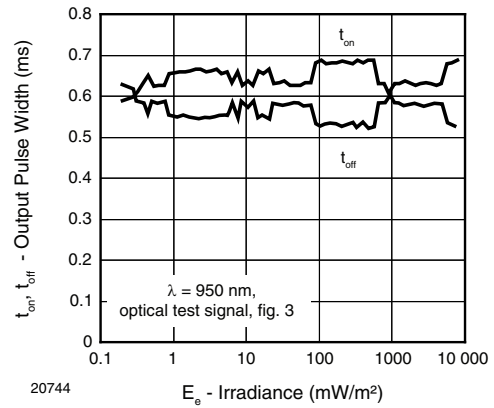

Fig. 4 - Output Pulse Diagram

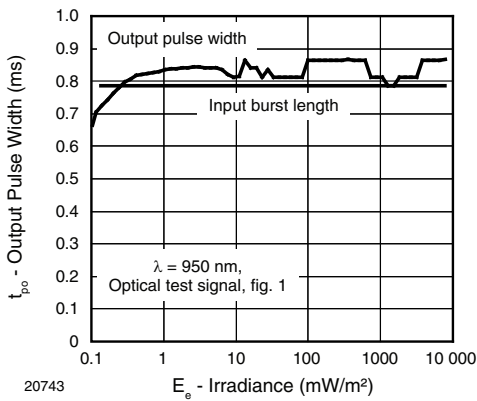

Fig. 2 - Pulse Length and Sensitivity in Dark Ambient

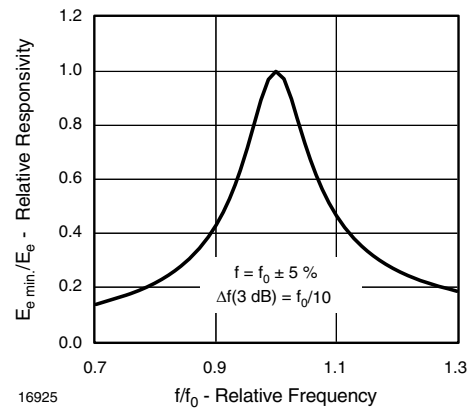

Fig. 5 - Frequency Dependence of Responsivity

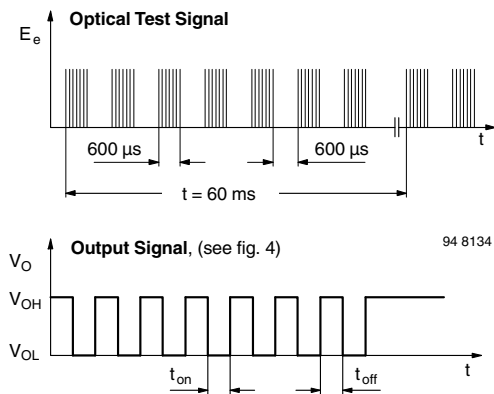

Fig. 3 - Output Function

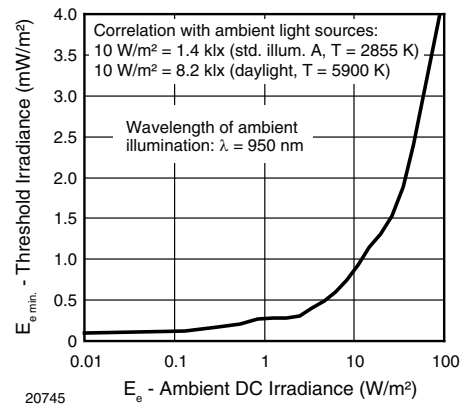

Fig. 6 - Sensitivity in Bright Ambient

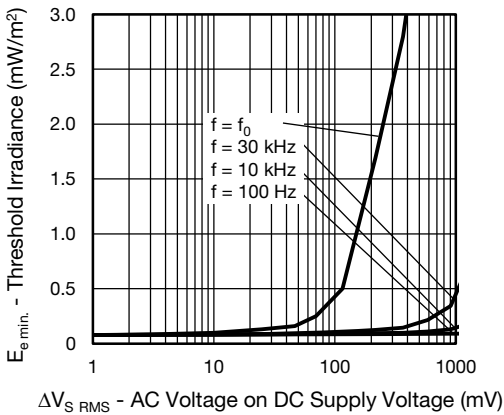

Fig. 7 - Sensitivity vs. Supply Voltage Disturbances



Fig. 10 - Relative Spectral Sensitivity vs. Wavelength

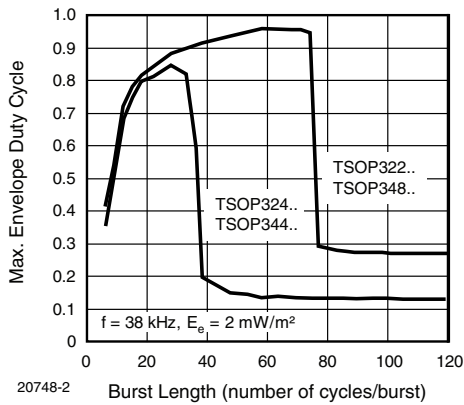

Fig. 8 - Max. Envelope Duty Cycle vs. Burst Length

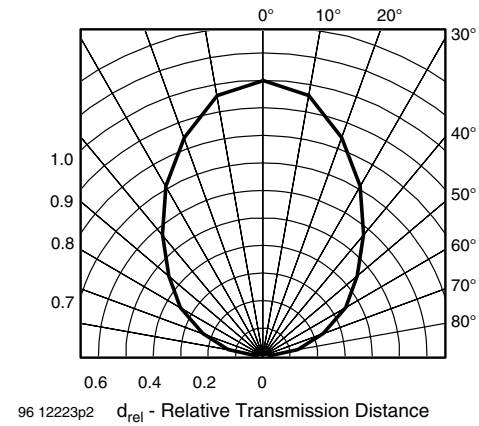

Fig. 11 - Horizontal Directivity

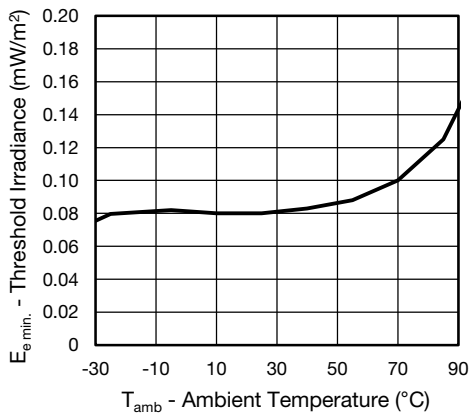

Fig. 9 - Sensitivity vs. Ambient Temperature

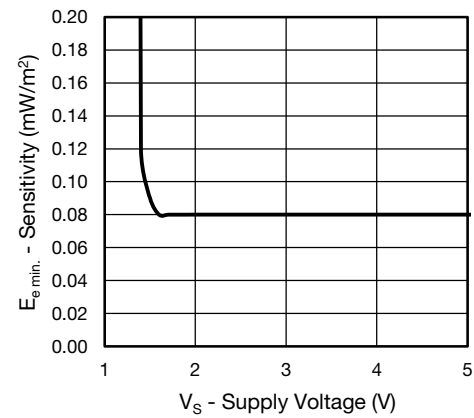

Fig. 12 - Sensitivity vs. Supply Voltage



## SUITABLE DATA FORMAT

This series is designed to suppress spurious output pulses due to noise or disturbance signals. The devices can distinguish data signals from noise due to differences in frequency, burst length, and envelope duty cycle. The data signal should be close to the device's band-pass center frequency (e.g. 38 kHz) and fulfill the conditions in the table below.

When a data signal is applied to the product in the presence of a disturbance, the sensitivity of the receiver is automatically reduced by the AGC to insure that no spurious pulses are present at the receiver's output. Some examples which are suppressed are:

- DC light (e.g. from tungsten bulbs sunlight)
- Continuous signals at any frequency
- Strongly or weakly modulated patterns from fluorescent lamps with electronic ballasts (see fig. 13 or fig. 14).

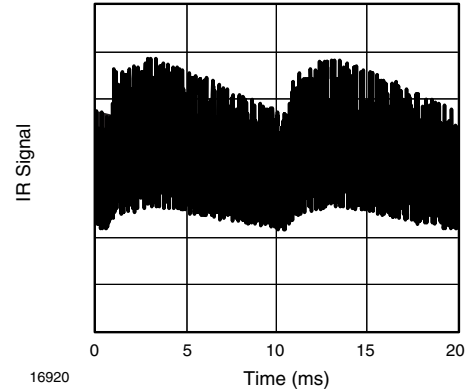

Fig. 13 - IR Disturbance from Fluorescent Lamp with Low Modulation

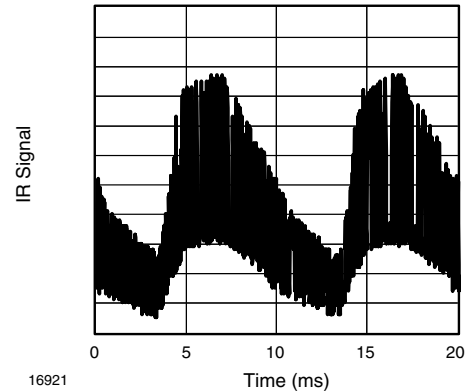

Fig. 14 - IR Disturbance from Fluorescent Lamp with High Modulation

|  | TSOP322.., TSOP348..  | TSOP324.., TSOP344..  |
|--|---|---|
| Minimum burst length   | 10 cycles/burst   | 10 cycles/burst   |
| After each burst of length a minimum gap time is required of               | 10 to 70 cycles<br>≥ 10 cycles  | 10 to 35 cycles<br>≥ 10 cycles  |
| For bursts greater than a minimum gap time in the data stream is needed of | 70 cycles<br>> 4 x burst length   | 35 cycles<br>> 10 x burst length  |
| Maximum number of continuous short bursts/second                           | 1800  | 1500  |
| NEC code   | Yes   | Preferred   |
| RC5/RC6 code   | Yes   | Preferred   |
| Thomson 56 kHz code  | Yes   | Preferred   |
| Sharp code   | Yes   | Preferred   |
| Suppression of interference from fluorescent lamps                         | Mild disturbance patterns are suppressed (example: signal pattern of fig. 13) | Complex and critical disturbance patterns are suppressed (example: signal pattern of fig. 14 or highly dimmed LCDs) |

### Notes

- For data formats with short bursts please see the datasheet for TSOP323.., TSOP325.., TSOP343.., TSOP345..
- For Sony 12, 15, and 20 bit IR codes please see the datasheet of TSOP34S40F, TSOP32S40F



## PACKAGE DIMENSIONS in millimeters



Drawing-No.: 6.550-5169.01-4  
Issue: 9; 03.11.10  
13655



## IR Receiver Modules for Remote Control Systems

Vishay offers stock molded IR receivers in four different packages:

- Loose packed in tubes, mounted on tape for reel or ammopack, or packed bulk in plastic bags.
- Vishay IR receiver with metal holders are packed in plastic trays. Vishay IR receiver with plastic holders are packed in plastic tubes.



### FEATURES

- Material categorization:  
For definitions of compliance please see [www.vishay.com/doc?99912](http://www.vishay.com/doc?99912)



### AVAILABLE FOR

- TSOP348..
- TSOP344..
- TSOP343..
- TSOP341..
- TSOP44...
- TSOP48...
- TSOP41...
- TSOP324..
- TSOP323..
- TSOP322..
- TSOP321..
- TSOP24...
- TSOP22...
- TSOP21...
- TSOP345..
- TSOP325..
- TSOP43...
- TSOP23...
- TSSP4..
- TSMP4..

### LOOSE PACKED IN TUBE

### ORDERING INFORMATION



O = for IR receiver applications  
M = for repeater/learning applications  
S = for sensor applications

#### Note

- d = "digit", please consult the list of available devices create a valid part number.

Example: TSOP4838

### PACKAGING QUANTITY

- 90 pieces per tube
- 24 tubes per carton

### PACKAGING DIMENSIONS in millimeters

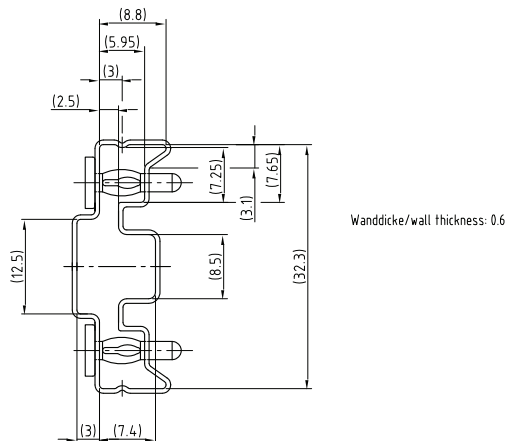

Drawing-No.: 9.700-5185.0-4  
Rev. 13; Date: 20.11.03  
20273-1

Druck / Printing for tubes  
1.400-5548.0-3 Version 1



## TAPE AND REEL/AMMOPACK

Up to 3 consecutive components may be missing if the gap is followed by at least 6 components. A maximum of 0.5 % of the components per reel quantity may be missing. At least 5 empty positions are present at the start and the end of the tape to enable insertion.

Tensile strength of the tape: > 15 N

Pulling force in the plane of the tape, at right angles to the reel: > 5 N



80079 tape on reel-s



80079 ammpack-s



| VERSION | DIMENSION "H" |
|---------|---------------|
| BS      | 20 ± 0.5      |
| PS      | 23.3 ± 0.5    |
| OS      | 26 ± 0.5      |

## ORDERING INFORMATION

T S d P

O = for IR receiver applications  
M = for repeater/learning applications  
S = for sensor applications

d d d d d

2 or 3 digit product series    2 digit frequency

S S 1

SS1 for T and R, bulk or ammpack

d d d d

dd = BS, PS or OS    Tape and reel    dd = 12 or 21

Z

Ammpack

### Note

- d = "digit", please consult the list of available devices create a valid part number.

Example: TSOP4838SS1BS12

TSOP2238SS1BS12Z

## PACKAGING QUANTITY

- 1000 pieces per reel
- 1000 pieces per ammpack





## BULK PACKAGING

The option "BK" signifies bulk packaging in conductive plastic bags. A maximum of 0.3 % of the components per box may be missing.

## ORDERING INFORMATION

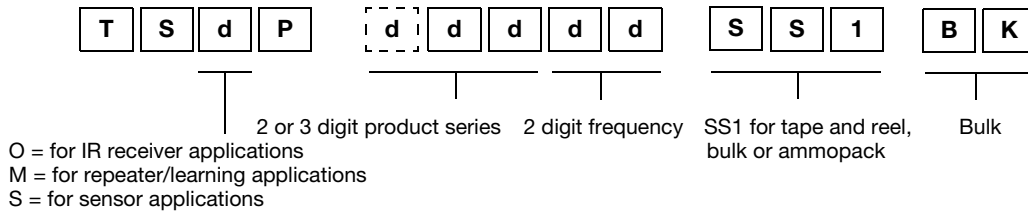

### Note

- d = "digit", please consult the list of available devices create a valid part number.

**EXAMPLE: TSOP4838SS1BK**  
**TSOP2238SS1BK**

## PACKAGING QUANTITY

- 250 pieces per bag (each bag is individually boxed)
- 6 bags per carton

## OUTER PACKAGING

| CARTON BOX DIMENSIONS in millimeters                           |                  |              |               |
|--|------------------|--------------|---------------|
|  |                  |              |               |
| <b>KINDS OF CARTON BOX</b>                                     | <b>THICKNESS</b> | <b>WIDTH</b> | <b>LENGTH</b> |
| <b>Packaging Plastic Tubes</b><br>(Normal/auxiliary devices)   | 80               | 150          | 600           |
| <b>Packaging Plastic Trays</b><br>(Devices with metal holders) | 120              | 290          | 490           |
| <b>Tape and Reel Box</b><br>(Taping in reels)                  | 400              | 310          | 410           |
| <b>Ammo-Box</b><br>(Zigzag taping)                             | 50               | 130          | 350           |



## Disclaimer

ALL PRODUCT, PRODUCT SPECIFICATIONS AND DATA ARE SUBJECT TO CHANGE WITHOUT NOTICE TO IMPROVE RELIABILITY, FUNCTION OR DESIGN OR OTHERWISE.

Vishay Intertechnology, Inc., its affiliates, agents, and employees, and all persons acting on its or their behalf (collectively, "Vishay"), disclaim any and all liability for any errors, inaccuracies or incompleteness contained in any datasheet or in any other disclosure relating to any product.

Vishay makes no warranty, representation or guarantee regarding the suitability of the products for any particular purpose or the continuing production of any product. To the maximum extent permitted by applicable law, Vishay disclaims (i) any and all liability arising out of the application or use of any product, (ii) any and all liability, including without limitation special, consequential or incidental damages, and (iii) any and all implied warranties, including warranties of fitness for particular purpose, non-infringement and merchantability.

Statements regarding the suitability of products for certain types of applications are based on Vishay's knowledge of typical requirements that are often placed on Vishay products in generic applications. Such statements are not binding statements about the suitability of products for a particular application. It is the customer's responsibility to validate that a particular product with the properties described in the product specification is suitable for use in a particular application. Parameters provided in datasheets and/or specifications may vary in different applications and performance may vary over time. All operating parameters, including typical parameters, must be validated for each customer application by the customer's technical experts. Product specifications do not expand or otherwise modify Vishay's terms and conditions of purchase, including but not limited to the warranty expressed therein.

Except as expressly indicated in writing, Vishay products are not designed for use in medical, life-saving, or life-sustaining applications or for any other application in which the failure of the Vishay product could result in personal injury or death. Customers using or selling Vishay products not expressly indicated for use in such applications do so at their own risk. Please contact authorized Vishay personnel to obtain written terms and conditions regarding products designed for such applications.

No license, express or implied, by estoppel or otherwise, to any intellectual property rights is granted by this document or by any conduct of Vishay. Product names and markings noted herein may be trademarks of their respective owners.

## Material Category Policy

**Vishay Intertechnology, Inc. hereby certifies that all its products that are identified as RoHS-Compliant fulfill the definitions and restrictions defined under Directive 2011/65/EU of The European Parliament and of the Council of June 8, 2011 on the restriction of the use of certain hazardous substances in electrical and electronic equipment (EEE) - recast, unless otherwise specified as non-compliant.**

**Please note that some Vishay documentation may still make reference to RoHS Directive 2002/95/EC. We confirm that all the products identified as being compliant to Directive 2002/95/EC conform to Directive 2011/65/EU.**

**Vishay Intertechnology, Inc. hereby certifies that all its products that are identified as Halogen-Free follow Halogen-Free requirements as per JEDEC JS709A standards. Please note that some Vishay documentation may still make reference to the IEC 61249-2-21 definition. We confirm that all the products identified as being compliant to IEC 61249-2-21 conform to JEDEC JS709A standards.**