

## SNx5LVDSxx High-Speed Differential Line Drivers

### 1 Features

- Meet or Exceed the Requirements of ANSI TIA/EIA-644 Standard
- Low-Voltage Differential Signaling With Typical Output Voltage of 350 mV and 100-Ω Load
- Typical Output Voltage Rise and Fall Times of 500 ps (400 Mbps)
- Typical Propagation Delay Times of 1.7 ns
- Operate From a Single 3.3-V Supply
- Power Dissipation 25 mW Typical Per Driver at 200 MHz
- Driver at High-Impedance When Disabled or With  $V_{CC} = 0$
- Bus-Terminal ESD Protection Exceeds 8 kV
- Low-Voltage TTL (LVTTTL) Logic Input Levels
- Pin Compatible With AM26LS31, MC3487, and  $\mu$ A9638
- Cold Sparring for Space and High-Reliability Applications Requiring Redundancy

### 2 Applications

- Wireless Infrastructure
- Telecom Infrastructure
- Printers

### 3 Description

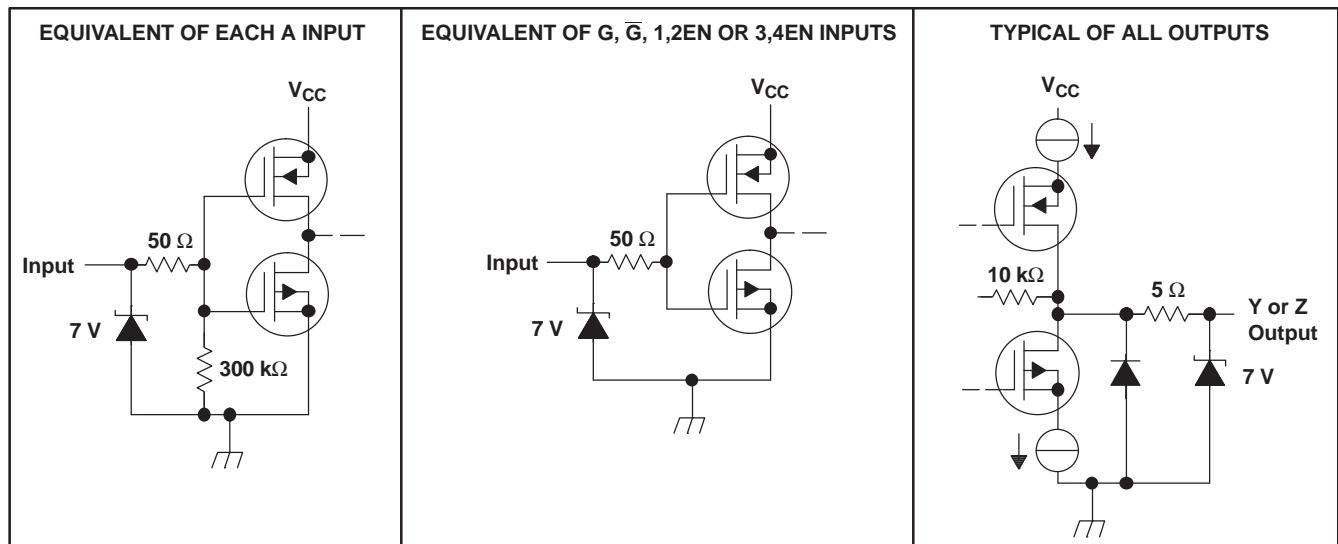
The SN55LVDS31, SN65LVDS31, SN65LVDS3487, and SN65LVDS9638 devices are differential line drivers that implement the electrical characteristics of low-voltage differential signaling (LVDS). This signaling technique lowers the output voltage levels of 5-V differential standard levels (such as TIA/EIA-422B) to reduce the power, increase the switching speeds, and allow operation with a 3.3-V supply rail. Any of the four current-mode drivers will deliver a minimum differential output voltage magnitude of 247 mV into a 100-Ω load when enabled.

#### Device Information<sup>(1)</sup>

PART NUMBER	PACKAGE	BODY SIZE (NOM)
SN55LVDS31	LCCC (20)	8.89 mm × 8.89 mm
	CDIP (16)	19.56 mm × 6.92 mm
	CFP (16)	10.30 mm × 6.73 mm
SN65LVDS31	SOIC (16)	9.90 mm × 3.91 mm
	SOP (16)	10.30 mm × 5.30 mm
	TSSOP (16)	5.00 mm × 4.40 mm
SN65LVDS3487	SOIC (16)	9.90 mm × 3.91 mm
	TSSOP (16)	5.00 mm × 4.40 mm
SN65LVDS9638	SOIC (8)	4.90 mm × 3.91 mm
	VSSOP (8)	3.00 mm × 3.00 mm
	HVSSOP (8)	3.00 mm × 3.00 mm

(1) For all available packages, see the orderable addendum at the end of the data sheet.

### Equivalent Input and Output Schematic Diagrams



## Table of Contents

<b>1 Features</b> .....	<b>1</b>	9.2 Functional Block Diagram .....	<b>14</b>
<b>2 Applications</b> .....	<b>1</b>	9.3 Feature Description .....	<b>14</b>
<b>3 Description</b> .....	<b>1</b>	9.4 Device Functional Modes .....	<b>16</b>
<b>4 Revision History</b> .....	<b>2</b>	<b>10 Application and Implementation</b> .....	<b>17</b>
<b>5 Description (Continued)</b> .....	<b>3</b>	10.1 Application Information .....	<b>17</b>
<b>6 Pin Configuration and Functions</b> .....	<b>4</b>	10.2 Typical Application .....	<b>17</b>
<b>7 Specifications</b> .....	<b>6</b>	<b>11 Power Supply Recommendations</b> .....	<b>23</b>
7.1 Absolute Maximum Ratings .....	<b>6</b>	<b>12 Layout</b> .....	<b>23</b>
7.2 ESD Ratings .....	<b>6</b>	12.1 Layout Guidelines .....	<b>23</b>
7.3 Recommended Operating Conditions .....	<b>7</b>	12.2 Layout Example .....	<b>25</b>
7.4 Thermal Information .....	<b>7</b>	<b>13 Device and Documentation Support</b> .....	<b>27</b>
7.5 Electrical Characteristics: SN55LVDS31 .....	<b>8</b>	13.1 Device Support .....	<b>27</b>
7.6 Electrical Characteristics: SN65LVDSxxxx .....	<b>9</b>	13.2 Documentation Support .....	<b>27</b>
7.7 Switching Characteristics: SN55LVDS31 .....	<b>9</b>	13.3 Related Links .....	<b>27</b>
7.8 Switching Characteristics: SN65LVDSxxxx .....	<b>10</b>	13.4 Trademarks .....	<b>27</b>
7.9 Typical Characteristics .....	<b>11</b>	13.5 Electrostatic Discharge Caution .....	<b>27</b>
<b>8 Parameter Measurement Information</b> .....	<b>12</b>	13.6 Glossary .....	<b>27</b>
<b>9 Detailed Description</b> .....	<b>14</b>	<b>14 Mechanical, Packaging, and Orderable Information</b> .....	<b>28</b>
9.1 Overview .....	<b>14</b>		

## 4 Revision History

<b>Changes from Revision L (July 2007) to Revision M</b>	<b>Page</b>
<ul style="list-style-type: none"> <li>Added <i>Pin Configuration and Functions</i> section, <i>ESD Ratings</i> table, <i>Feature Description</i> section, <i>Device Functional Modes</i>, <i>Application and Implementation</i> section, <i>Power Supply Recommendations</i> section, <i>Layout</i> section, <i>Device and Documentation Support</i> section, and <i>Mechanical, Packaging, and Orderable Information</i> section .....</li> </ul>	<b>1</b>

<b>Changes from Revision K (March 2004) to Revision L</b>	<b>Page</b>
<ul style="list-style-type: none"> <li>Added Cold Sparing Feature .....</li> </ul>	<b>1</b>
<ul style="list-style-type: none"> <li>Added Cold Sparing information .....</li> </ul>	<b>14</b>

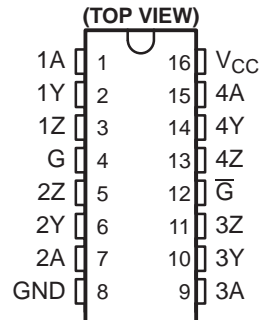
## 5 Description (Continued)

The intended application of these devices and signaling technique is both point-to-point and multidrop (one driver and multiple receivers) data transmission over controlled impedance media of approximately 100  $\Omega$ . The transmission media may be printed-circuit board traces, backplanes, or cables. The ultimate rate and distance of data transfer is dependent upon the attenuation characteristics of the media and the noise coupling to the environment.

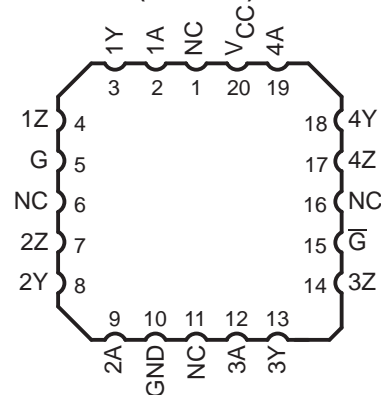
The SN65LVDS31, SN65LVDS3487, and SN65LVDS9638 devices are characterized for operation from  $-40^{\circ}\text{C}$  to  $85^{\circ}\text{C}$ . The SN55LVDS31 device is characterized for operation from  $-55^{\circ}\text{C}$  to  $125^{\circ}\text{C}$ .

## 6 Pin Configuration and Functions

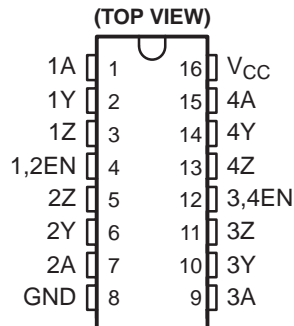
**SN55LVDS31 ... J OR W**  
**SN65LVDS31 ... D OR PW**  
 (Marked as LVDS31 or 65LVDS31)



**SN55LVDS31FK**  
**(TOP VIEW)**



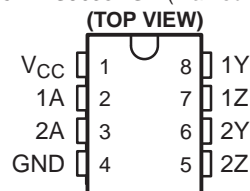
**SN65LVDS3487D**  
 (Marked as LVDS3487 or 65LVDS3487)



**SN65LVDS9638D** (Marked as **DK638** or **LVDS38**)

**SN65LVDS9638DGN** (Marked as **L38**)

**SN65LVDS9638DGK** (Marked as **AXG**)



**Pin Functions: SN55LVDS31 J or W, SN65LVDS31 D or PW**

PIN		I/O	DESCRIPTION
NAME	NUMBER		
V <sub>CC</sub>	16	–	Supply voltage
GND	8	–	Ground
1A	1	I	LVTTTL input signal
1Y	2	O	Differential (LVDS) non-inverting output
1Z	3	O	Differential (LVDS) inverting output
2A	7	I	LVTTTL input signal
2Y	6	O	Differential (LVDS) non-inverting output
2Z	5	O	Differential (LVDS) inverting output
3A	9	I	LVTTTL input signal
3Y	10	O	Differential (LVDS) non-inverting output
3Z	11	O	Differential (LVDS) inverting output
4A	15	I	LVTTTL input signal
4Y	14	O	Differential (LVDS) non-inverting output
4Z	13	O	Differential (LVDS) inverting output
G	4	I	Enable (HI = ENABLE)
G/	12	I	Enable (LO = ENABLE)

**Pin Functions: SN65LVDS31FK**

PIN		I/O	DESCRIPTION
NAME	NUMBER		
V <sub>CC</sub>	20	–	Supply voltage
GND	10	–	Ground
1A	2	I	LVTTTL input signal
1Y	3	O	Differential (LVDS) non-inverting output
1Z	4	O	Differential (LVDS) inverting output
2A	9	I	LVTTTL input signal
2Y	8	O	Differential (LVDS) non-inverting output
2Z	7	O	Differential (LVDS) inverting output
3A	12	I	LVTTTL input signal
3Y	13	O	Differential (LVDS) non-inverting output
3Z	14	O	Differential (LVDS) inverting output
4A	19	I	LVTTTL input signal
4Y	18	O	Differential (LVDS) non-inverting output
4Z	17	O	Differential (LVDS) inverting output
G	5	I	Enable (HI = ENABLE)
G/	15	I	Enable (LO = ENABLE)
NC	1, 6, 11, 16	–	No connection

**Pin Functions: SN65LVDS3487D**

PIN		I/O	DESCRIPTION
NAME	NUMBER		
V <sub>CC</sub>	16	–	Supply voltage
GND	8	–	Ground
1A	1	I	LVTTTL input signal
1Y	2	O	Differential (LVDS) non-inverting output
1Z	3	O	Differential (LVDS) inverting output
2A	7	I	LVTTTL input signal

**Pin Functions: SN65LVDS3487D (continued)**

PIN		I/O	DESCRIPTION
NAME	NUMBER		
2Y	6	O	Differential (LVDS) non-inverting output
2Z	5	O	Differential (LVDS) inverting output
3A	9	I	LVTTTL input signal
3Y	10	O	Differential (LVDS) non-inverting output
3Z	11	O	Differential (LVDS) inverting output
4A	15	I	LVTTTL input signal
4Y	14	O	Differential (LVDS) non-inverting output
4Z	13	O	Differential (LVDS) inverting output
1,2EN	4	I	Enable for channels 1 and 2
3,4EN	12	I	Enable for channels 3 and 4

**Pin Functions: SN65LVDS9638D, SN65LVDS9638DGN, SN65LVDS9638DGK**

PIN		I/O	DESCRIPTION
NAME	NUMBER		
V <sub>CC</sub>	1	–	Supply voltage
GND	4	–	Ground
1A	2	I	LVTTTL input signal
1Y	8	O	Differential (LVDS) non-inverting output
1Z	7	O	Differential (LVDS) inverting output
2A	3	I	LVTTTL input signal
2Y	6	O	Differential (LVDS) non-inverting output
2Z	5	O	Differential (LVDS) inverting output

## 7 Specifications

### 7.1 Absolute Maximum Ratings<sup>(1)</sup>

over operating free-air temperature range (unless otherwise noted)

		MIN	MAX	UNIT
V <sub>CC</sub>	Supply voltage range <sup>(2)</sup>	–0.5	4	V
V <sub>I</sub>	Input voltage range	–0.5	V <sub>CC</sub> + 0.5	V
	Continuous total power dissipation	See <a href="#">Thermal Information</a>		
	Lead temperature 1.6 mm (1/16 inch) from case for 10 seconds		260	°C
T <sub>stg</sub>	Storage temperature	–65	150	°C

- (1) Stresses beyond those listed under *Absolute Maximum Ratings* may cause permanent damage to the device. These are stress ratings only, and functional operation of the device at these or any other conditions beyond those indicated under *Recommended Operating Conditions* is not implied. Exposure to absolute-maximum-rated conditions for extended periods may affect device reliability.
- (2) All voltages, except differential I/O bus voltages, are with respect to the network ground terminal.

### 7.2 ESD Ratings

		VALUE	UNIT	
V <sub>(ESD)</sub>	Electrostatic discharge	Human body model (HBM), per ANSI/ESDA/JEDEC JS-001, all pins <sup>(1)</sup>	±8000	V
	Lead temperature 1.6 mm (1/16 inch) from case for 10 seconds		260	°C

- (1) JEDEC document JEP155 states that 500-V HBM allows safe manufacturing with a standard ESD control process.

### 7.3 Recommended Operating Conditions

			MIN	NOM	MAX	UNIT
V <sub>CC</sub>	Supply voltage		3	3.3	3.6	V
V <sub>IH</sub>	High-level input voltage		2			V
V <sub>IL</sub>	Low-level input voltage				0.8	V
T <sub>A</sub>	Operating free-air temperature	SN65 prefix	-40		85	°C
		SN55 prefix	-55		125	

### 7.4 Thermal Information

THERMAL METRIC <sup>(1)</sup>	SN55LVDS31			SN65LVDS31			SN65LVDS3487		SN65LVDS9638			UNIT			
	FK	J	W	D	NS	PW	D	PW	D	DGK	DGN <sup>(2)</sup>				
	20 PINS	16 PINS	16 PINS	16 PINS	16 PINS	16 PINS	16 PINS	16 PINS	8 PINS	8 PINS	8 PINS				
R <sub>θJA</sub>	Junction-to-ambient thermal resistance			84.8	86.0							°C/W			
R <sub>θJC(top)</sub>	Junction-to-case (top) thermal resistance			46.0	44.2										
R <sub>θJB</sub>	Junction-to-board thermal resistance			41.8	26.4										
ψ <sub>JT</sub>	Junction-to-top characterization parameter			11.1	10.9										
ψ <sub>JB</sub>	Junction-to-board characterization parameter			41.5	46.1										
Power Rating	T <sub>A</sub> ≤ 25°C			1375	1375	1000	950	—	774	950	774	725	425	2140	mW
	T <sub>A</sub> ≤ 70°C			880	880	640	608	—	496	608	496	464	272	1370	
	T <sub>A</sub> ≤ 85°C			715	715	520	494	—	402	494	402	377	221	1110	
	T <sub>A</sub> ≤ 125°C			275	275	200	—	—	—	—	—	—	—	—	

(1) For more information about traditional and new thermal metrics, see the *IC Package Thermal Metrics* application report, [SPRA953](#).

(2) The PowerPAD™ must be soldered to a thermal land on the printed-circuit board. See the application note *PowerPAD Thermally Enhanced Package (SLMA002)*.

## 7.5 Electrical Characteristics: SN55LVDS31

over operating free-air temperature range (unless otherwise noted)

PARAMETER		TEST CONDITIONS	MIN	TYP <sup>(1)</sup>	MAX	UNIT
$V_{OD}$	Differential output voltage magnitude	$R_L = 100 \Omega$ , See Figure 5	247	340	454	mV
$\Delta V_{OD}$	Change in differential output voltage magnitude between logic states	$R_L = 100 \Omega$ , See Figure 5	-50		50	mV
$V_{OC(SS)}$	Steady-state common-mode output voltage	See Figure 6	1.125	1.2	1.375	V
$\Delta V_{OC(SS)}$	Change in steady-state common-mode output voltage between logic states	See Figure 6	-50		50	mV
$V_{OC(PP)}$	Peak-to-peak common-mode output voltage	See Figure 6		50	150	mV
$I_{CC}$	Supply current	$V_I = 0.8$ or $2$ V, Enabled, No load		9	20	mA
		$V_I = 0.8$ or $2$ V, $R_L = 100 \Omega$ , Enabled		25	35	
		$V_I = 0$ or $V_{CC}$ , Disabled		0.25	1	
$I_{IH}$	High-level input current	$V_{IH} = 2$		4	20	$\mu$ A
$I_{IL}$	Low-level input current	$V_{IL} = 0.8$ V		0.1	10	$\mu$ A
$I_{OS}$	Short-circuit output current	$V_{O(Y)}$ or $V_{O(Z)} = 0$		-4	-24	mA
		$V_{OD} = 0$			$\pm 12$	
$I_{OZ}$	High-impedance output current	$V_O = 0$ or $2.4$ V			$\pm 1$	$\mu$ A
$I_{O(OFF)}$	Power-off output current	$V_{CC} = 0$ , $V_O = 2.4$ V			$\pm 4$	$\mu$ A
$C_i$	Input capacitance			3		pF

 (1) All typical values are at  $T_A = 25^\circ\text{C}$  and with  $V_{CC} = 3.3$  V.



## 7.6 Electrical Characteristics: SN65LVDSxxxx

over recommended operating conditions (unless otherwise noted)

PARAMETER		TEST CONDITIONS	SN65LVDS31 SN65LVDS3487 SN65LVDS9638			UNIT	
			MIN	TYP <sup>(1)</sup>	MAX		
V <sub>OD</sub>	Differential output voltage magnitude	R <sub>L</sub> = 100 Ω, See Figure 5	247	340	454	mV	
ΔV <sub>OD</sub>	Change in differential output voltage magnitude between logic states	R <sub>L</sub> = 100 Ω, See Figure 5	-50		50	mV	
V <sub>OC(SS)</sub>	Steady-state common-mode output voltage	See Figure 6	1.125	1.2	1.375	V	
ΔV <sub>OC(SS)</sub>	Change in steady-state common-mode output voltage between logic states	See Figure 6	-50		50	mV	
V <sub>OC(PP)</sub>	Peak-to-peak common-mode output voltage	See Figure 6		50	150	mV	
I <sub>CC</sub>	Supply current	SN65LVDS31 SN65LVDS3487	V <sub>I</sub> = 0.8 V or 2 V, Enabled, No load		9	20	mA
			V <sub>I</sub> = 0.8 or 2 V, R <sub>L</sub> = 100 Ω, Enabled		25	35	
		SN65LVDS9638	V <sub>I</sub> = 0 or V <sub>CC</sub> , Disabled		0.25	1	mA
			V <sub>I</sub> = 0.8 V or 2 V	No load	4.7	8	
		R <sub>L</sub> = 100 Ω		9	13		
I <sub>IH</sub>	High-level input current	V <sub>IH</sub> = 2		4	20	μA	
I <sub>IL</sub>	Low-level input current	V <sub>IL</sub> = 0.8 V		0.1	10	μA	
I <sub>OS</sub>	Short-circuit output current	V <sub>O(Y)</sub> or V <sub>O(Z)</sub> = 0 V <sub>OD</sub> = 0		-4	-24	mA	
					±12		
I <sub>OZ</sub>	High-impedance output current	V <sub>O</sub> = 0 or 2.4 V			±1	μA	
I <sub>O(OFF)</sub>	Power-off output current	V <sub>CC</sub> = 0, V <sub>O</sub> = 2.4 V			±1	μA	
C <sub>i</sub>	Input capacitance			3		pF	

 (1) All typical values are at T<sub>A</sub> = 25°C and with V<sub>CC</sub> = 3.3 V.

## 7.7 Switching Characteristics: SN55LVDS31

over recommended operating conditions (unless otherwise noted)

PARAMETER		TEST CONDITIONS	MIN	TYP <sup>(1)</sup>	MAX	UNIT
t <sub>PLH</sub>	Propagation delay time, low-to-high-level output	R <sub>L</sub> = 100 Ω, C <sub>L</sub> = 10 pF See Figure 5	0.5	1.4	4	ns
t <sub>PHL</sub>	Propagation delay time, high-to-low-level output		1	1.7	4.5	ns
t <sub>r</sub>	Differential output signal rise time (20% to 80%)		0.4	0.5	1	ns
t <sub>f</sub>	Differential output signal fall time (80% to 20%)		0.4	0.5	1	ns
t <sub>sk(p)</sub>	Pulse skew ( t <sub>PHL</sub> - t <sub>PLH</sub>  )			0.3	0.6	ns
t <sub>sk(o)</sub>	Channel-to-channel output skew <sup>(2)</sup>			0.3	0.6	ns
t <sub>PZH</sub>	Propagation delay time, high-impedance-to-high-level output	See Figure 7		5.4	15	ns
t <sub>PZL</sub>	Propagation delay time, high-impedance-to-low-level output			2.5	15	ns
t <sub>PHZ</sub>	Propagation delay time, high-level-to-high-impedance output			8.1	17	ns
t <sub>PLZ</sub>	Propagation delay time, low-level-to-high-impedance output			7.3	15	ns

 (1) All typical values are at T<sub>A</sub> = 25°C and with V<sub>CC</sub> = 3.3 V.

 (2) t<sub>sk(o)</sub> is the maximum delay time difference between drivers on the same device.

## 7.8 Switching Characteristics: SN65LVDSxxxx

over recommended operating conditions (unless otherwise noted)

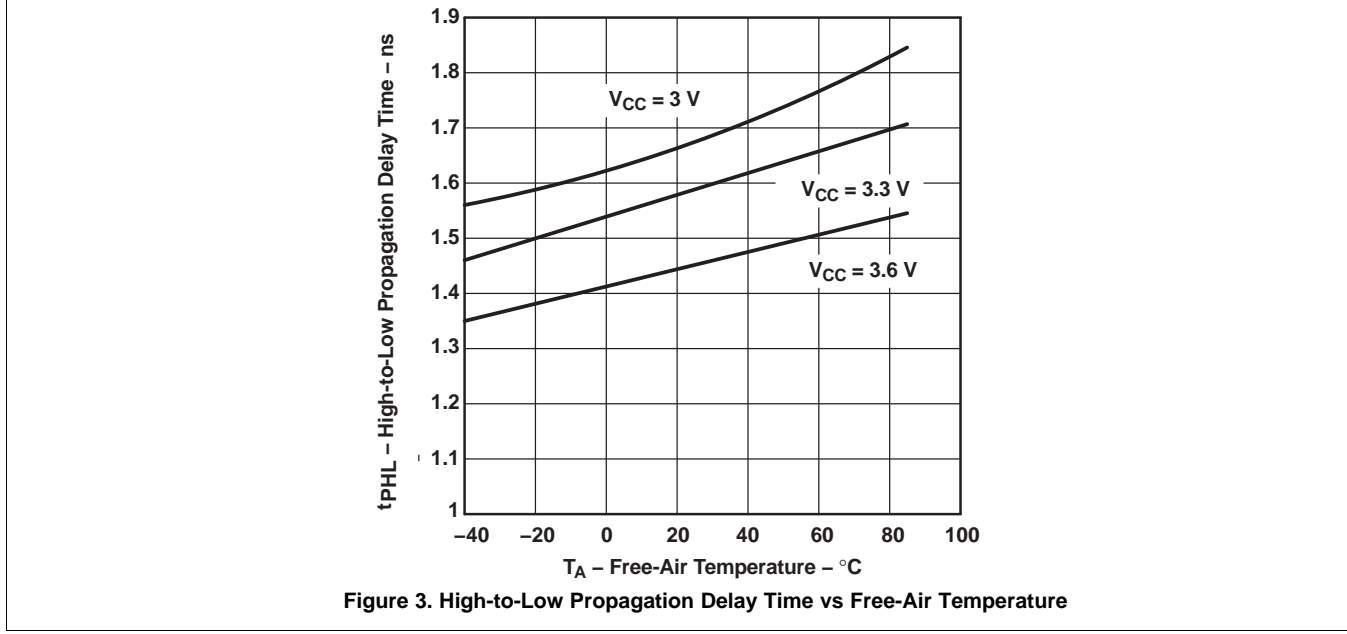
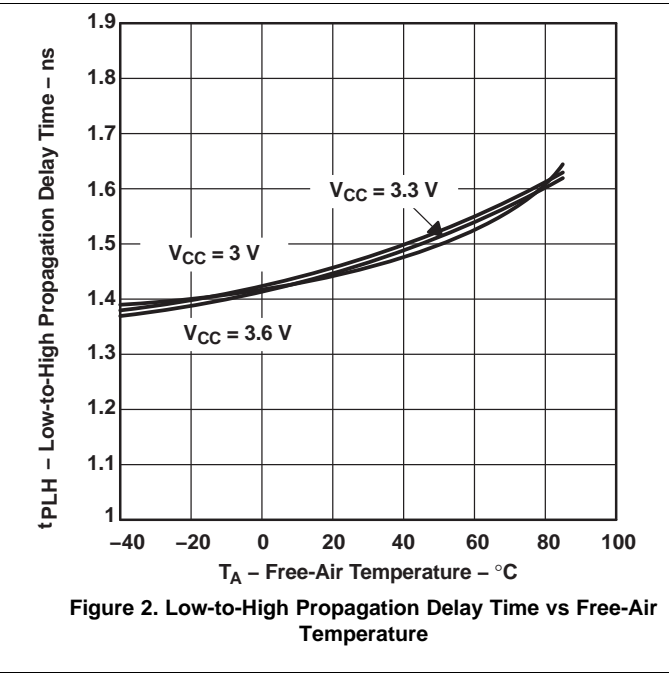
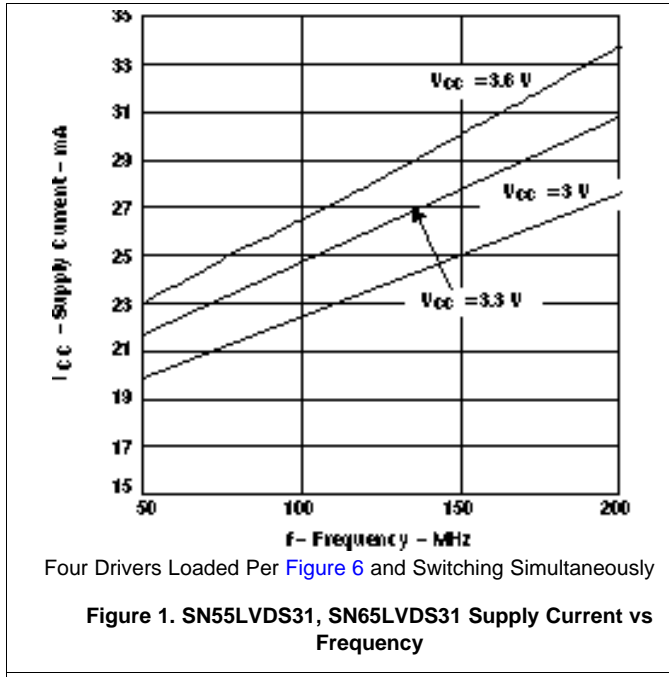
PARAMETER	TEST CONDITIONS	SN65LVDS31 SN65LVDS3487 SN65LVDS9638			UNIT
		MIN	TYP <sup>(1)</sup>	MAX	
$t_{PLH}$	Propagation delay time, low-to-high-level output	0.5	1.4	2	ns
$t_{PHL}$	Propagation delay time, high-to-low-level output	1	1.7	2.5	ns
$t_r$	Differential output signal rise time (20% to 80%)	0.4	0.5	0.6	ns
$t_f$	Differential output signal fall time (80% to 20%)	0.4	0.5	0.6	ns
$t_{sk(p)}$	Pulse skew ( $ t_{PHL} - t_{PLH} $ )		0.3	0.6	ns
$t_{sk(o)}$	Channel-to-channel output skew <sup>(2)</sup>		0	0.3	ns
$t_{sk(pp)}$	Part-to-part skew <sup>(3)</sup>			800	ps
$t_{PZH}$	Propagation delay time, high-impedance-to-high-level output		5.4	15	ns
$t_{PZL}$	Propagation delay time, high-impedance-to-low-level output		2.5	15	ns
$t_{PHZ}$	Propagation delay time, high-level-to-high-impedance output		8.1	15	ns
$t_{PLZ}$	Propagation delay time, low-level-to-high-impedance output		7.3	15	ns

 (1) All typical values are at  $T_A = 25^\circ\text{C}$  and with  $V_{CC} = 3.3\text{ V}$ .

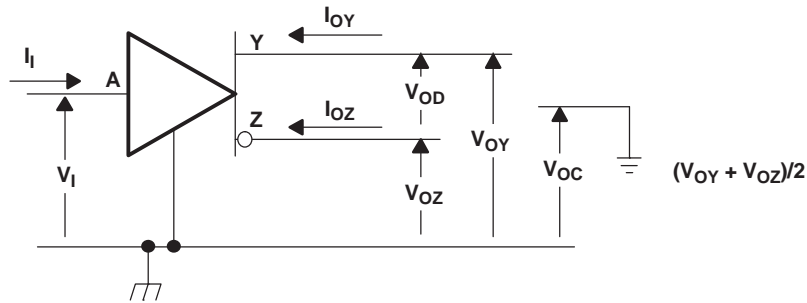
 (2)  $t_{sk(o)}$  is the skew between specified outputs of a single device with all driving inputs connected together and the outputs switching in the same direction while driving identical specified loads.

 (3)  $t_{sk(pp)}$  is the magnitude of the difference in propagation delay times between any specified terminals of two devices when both devices operate with the same supply voltages, same temperature, and have identical packages and test circuits.

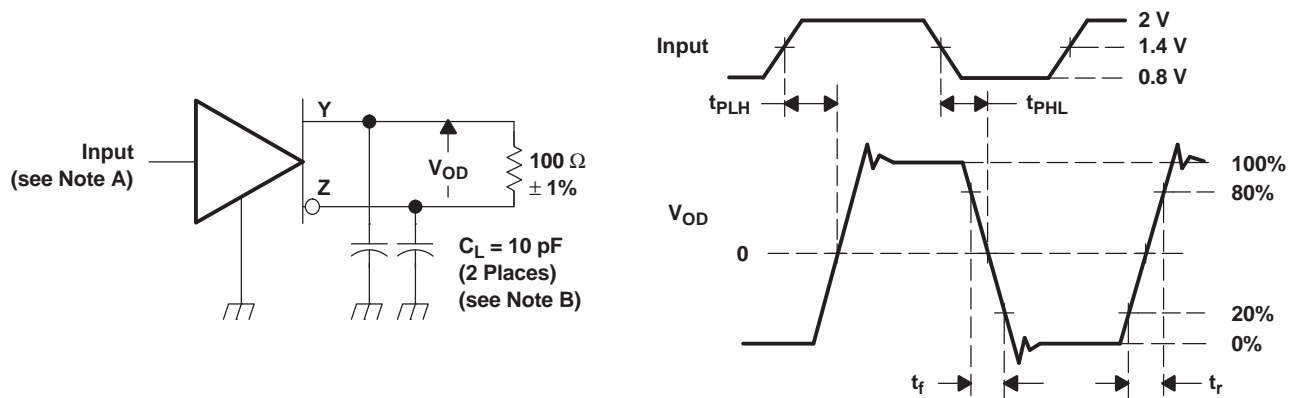
### 7.9 Typical Characteristics



## 8 Parameter Measurement Information

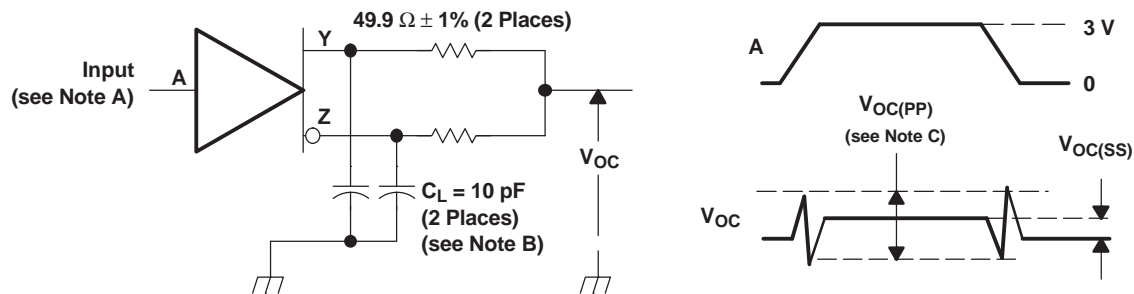


**Figure 4. Voltage and Current Definitions**



- NOTES: A. All input pulses are supplied by a generator having the following characteristics:  $t_r$  or  $t_f \leq 1$  ns, pulse repetition rate (PRR) = 50 Mpps, pulse width =  $10 \pm 0.2$  ns.  
 B.  $C_L$  includes instrumentation and fixture capacitance within 6 mm of the D.U.T.

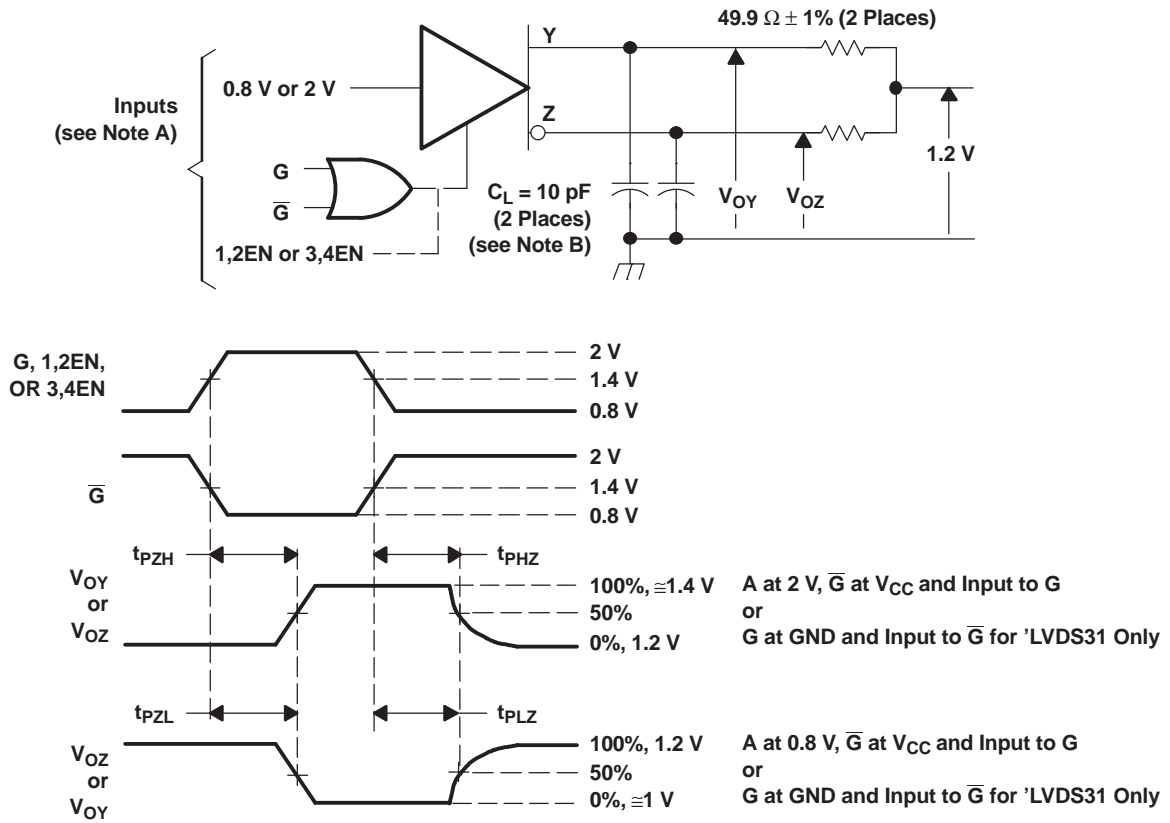
**Figure 5. Test Circuit, Timing, and Voltage Definitions for the Differential Output Signal**



- NOTES: A. All input pulses are supplied by a generator having the following characteristics:  $t_r$  or  $t_f \leq 1$  ns, pulse repetition rate (PRR) = 50 Mpps, pulse width =  $10 \pm 0.2$  ns.  
 B.  $C_L$  includes instrumentation and fixture capacitance within 6 mm of the D.U.T.  
 C. The measurement of  $V_{OC(PP)}$  is made on test equipment with a  $-3$ -dB bandwidth of at least 300 MHz.

**Figure 6. Test Circuit and Definitions for the Driver Common-Mode Output Voltage**

Parameter Measurement Information (continued)



- NOTES: A. All input pulses are supplied by a generator having the following characteristics:  $t_r$  or  $t_f < 1 \text{ ns}$ , pulse repetition rate (PRR) = 0.5 Mpps, pulse width =  $500 \pm 10 \text{ ns}$ .
- B.  $C_L$  includes instrumentation and fixture capacitance within 6 mm of the D.U.T.

Figure 7. Enable or Disable Time Circuit and Definitions

## 9 Detailed Description

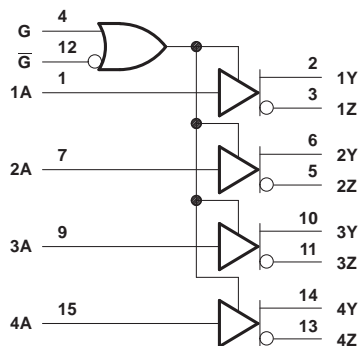
### 9.1 Overview

The SNx5LVDSxx devices are dual- and quad-channel LVDS line drivers. They operate from a single supply that is nominally 3.3 V, but can be as low as 3 V and as high as 3.6 V. The input signal to the SN65LVDS1 device is an LVTTTL signal. The output of the device is a differential signal complying with the LVDS standard (TIA/EIA-644A). The differential output signal operates with a signal level of 340 mV, nominally, at a common-mode voltage of 1.2 V. This low differential output voltage results in a low emitted radiated energy, which is dependent on the signal slew rate. The differential nature of the output provides immunity to common-mode coupled signals.

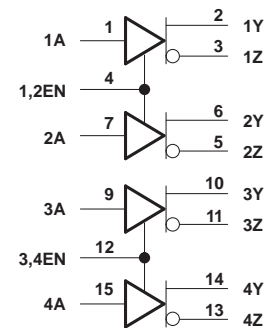
The SNx5LVDSxx devices are intended to drive a 100-Ω transmission line. This transmission line may be a printed-circuit board (PCB) or cabled interconnect. With transmission lines, the optimum signal quality and power delivery is reached when the transmission line is terminated with a load equal to the characteristic impedance of the interconnect. Likewise, the driven 100-Ω transmission line should be terminated with a matched resistance.

### 9.2 Functional Block Diagram

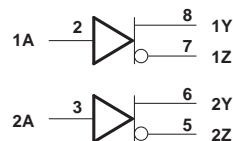
<sup>1</sup>LVDS31 logic diagram (positive logic)



SN65LVDS3487 logic diagram (positive logic)



SN65LVDS9638 logic diagram (positive logic)



### 9.3 Feature Description

#### 9.3.1 Driver Disabled Output

When the SNx5LVDSxx driver is disabled, or when power is removed from the device, the driver outputs are high-impedance.

#### 9.3.2 NC Pins

NC (not connected) pins are pins where the die is not physically connected to the lead frame or package. For optimum thermal performance, a good rule of thumb is to ground the NC pins at the board level.

#### 9.3.3 Unused Enable Pins

Unused enable pins should be tied to  $V_{CC}$  or GND as appropriate.

## Feature Description (continued)

### 9.3.4 Driver Equivalent Schematics

The driver input is represented by a CMOS inverter stage with a 7-V Zener diode. The input stage is high-impedance, and includes an internal pulldown to ground. If the driver input is left open, the driver input provides a low-level signal to the rest of the driver circuitry, resulting in a low-level signal at the driver output pins. The Zener diode provides ESD protection. The driver output stage is a differential pair, one half of which is shown in [Figure 8](#). Like the input stage, the driver output includes Zener diodes for ESD protection. The schematic shows an output stage that includes a set of current sources (nominally 3.5 mA) that are connected to the output load circuit based upon the input stage signal. To the first order, the SNx5LVDSxx output stage acts a constant-current source.

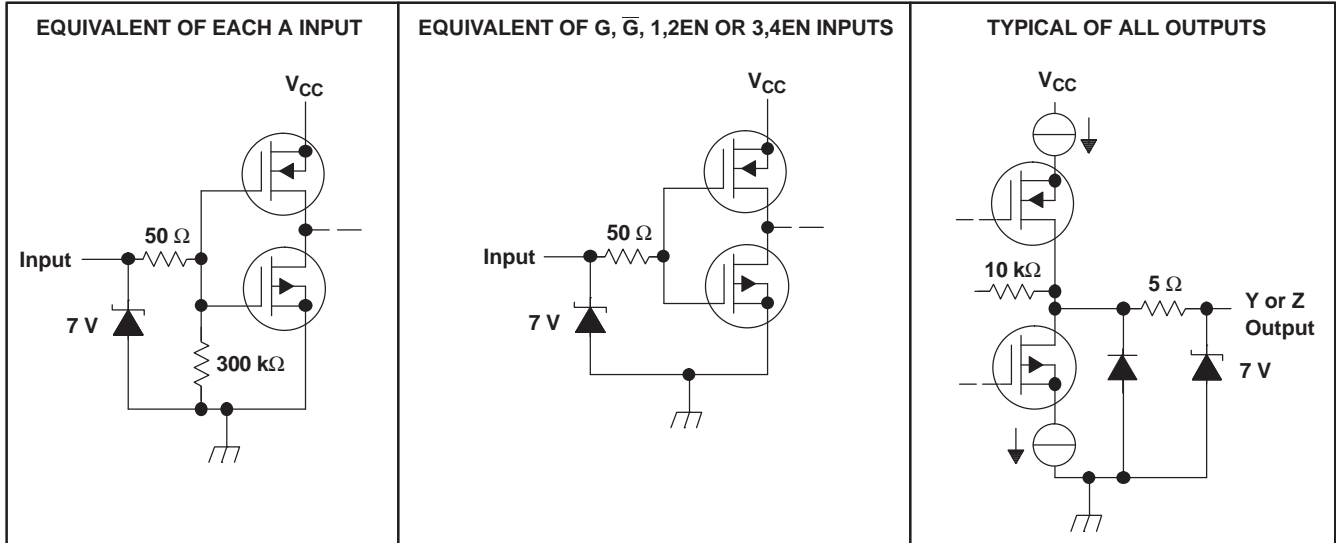


Figure 8. Equivalent Input and Output Schematic Diagrams

## 9.4 Device Functional Modes

**Table 1. SN55LVDS31, SN65LVDS31<sup>(1)</sup>**

INPUT A	ENABLES		OUTPUTS	
	G	G	Y	Z
H	H	X	H	L
L	H	X	L	H
H	X	L	H	L
L	X	L	L	H
X	L	H	Z	Z
Open	H	X	L	H
Open	X	L	L	H

(1) H = high level, L = low level, X = irrelevant, Z = high-impedance (off)

**Table 2. SN65LVDS3487<sup>(1)</sup>**

INPUT A	ENABLE EN	OUTPUTS	
		Y	Z
H	H	H	L
L	H	L	H
X	L	Z	Z
Open	H	L	H

(1) H = high level, L = low level, X = irrelevant, Z = high-impedance (off)

**Table 3. SN65LVDS9638<sup>(1)</sup>**

INPUT A	OUTPUTS	
	Y	Z
H	H	L
L	L	H
Open	L	H

(1) H = high level, L = low level



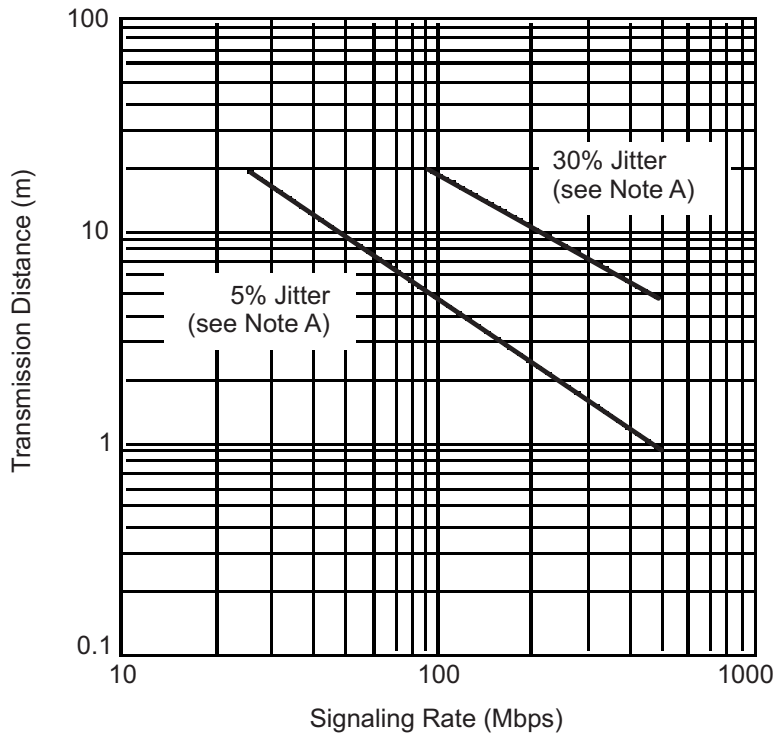
## 10 Application and Implementation

### NOTE

Information in the following applications sections is not part of the TI component specification, and TI does not warrant its accuracy or completeness. TI's customers are responsible for determining suitability of components for their purposes. Customers should validate and test their design implementation to confirm system functionality.

### 10.1 Application Information

The SNx5LVDSxx devices are dual- and quad-channel LVDS drivers. These devices are generally used as building blocks for high-speed, point-to-point, data transmission where ground differences are less than 1 V. LVDS drivers and receivers provide high-speed signaling rates that are often implemented with ECL class devices without the ECL power and dual-supply requirements. A common question with any class of driver is how far and how fast can the devices operate. While individual drivers and receivers have specifications that define their inherent switching rate, a communication link will quite often be limited by the impairments introduced by the interconnecting media. Figure 9 shows the typical relationship between signaling rate and distance achievable depends on the quality of the eye pattern at the receiver that is either desired or needed. Figure 9 shows the curves representing 5% and 30% eye closure due to inter-symbol interference (ISI).



24 A WG UTP 96  $\Omega$  (PVC Dielectric)

A. This parameter is the percentage of distortion of the unit interval (UI) with a pseudorandom data pattern.

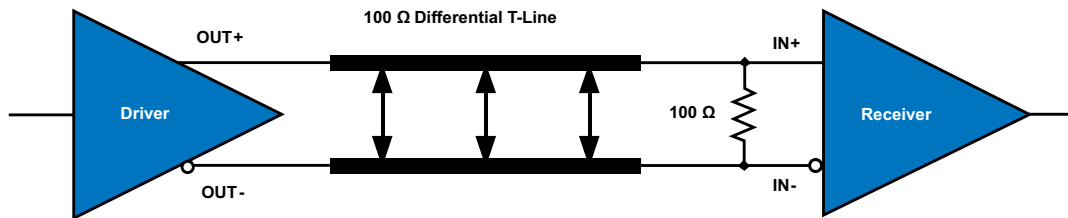
**Figure 9. Typical Transmission Distance vs Signaling Rate**

### 10.2 Typical Application

#### 10.2.1 Point-to-Point Communications

The most basic application for LVDS buffers, as found in this data sheet, is for point-to-point communications of digital data, as shown in Figure 10.

## Typical Application (continued)



**Figure 10. Point-to-Point Topology**

A point-to-point communications channel has a single transmitter (driver) and a single receiver. This communications topology is often referred to as simplex. In [Figure 10](#) the driver receives a single-ended input signal and the receiver outputs a single-ended recovered signal. The LVDS driver converts the single-ended input to a differential signal for transmission over a balanced interconnecting media of 100-Ω characteristic impedance. The conversion from a single-ended signal to an LVDS signal retains the digital data payload while translating to a signal whose features are more appropriate for communication over extended distances or in a noisy environment.

### 10.2.1.1 Design Requirements

DESIGN PARAMETERS	EXAMPLE VALUE
Driver Supply Voltage ( $V_{CCD}$ )	3.0 to 3.6 V
Driver Input Voltage	0.8 to 3.3 V
Driver Signaling Rate	DC to 400 Mbps
Interconnect Characteristic Impedance	100 Ω
Termination Resistance	100 Ω
Number of Receiver Nodes	1
Receiver Supply Voltage ( $V_{CCR}$ )	3.0 to 3.6 V
Receiver Input Voltage	0 to 2.4 V
Receiver Signaling Rate	DC to 400 Mbps
Ground shift between driver and receiver	±1 V

### 10.2.1.2 Detailed Design Procedure

#### 10.2.1.2.1 Driver Supply Voltage

The SNx5LVDSxx driver is operated from a single supply. The device can support operation with a supply as low as 3 V and as high as 3.6 V. The differential output voltage is nominally 340 mV over the complete output range. The minimum output voltage stays within the specified LVDS limits (247 mV to 454 mV) for a 3.3-V supply.

#### 10.2.1.2.2 Driver Bypass Capacitance

Bypass capacitors play a key role in power distribution circuitry. Specifically, they create low-impedance paths between power and ground. At low frequencies, a good digital power supply offers very-low-impedance paths between its terminals. However, as higher frequency currents propagate through power traces, the source is quite often incapable of maintaining a low-impedance path to ground. Bypass capacitors are used to address this shortcoming. Usually, large bypass capacitors (10 to 1000 μF) at the board-level do a good job up into the kHz range. Due to their size and length of their leads, they tend to have large inductance values at the switching frequencies of modern digital circuitry. To solve this problem, one should resort to the use of smaller capacitors (nF to μF range) installed locally next to the integrated circuit.

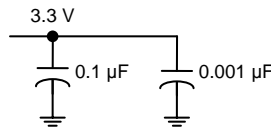
Multilayer ceramic chip or surface-mount capacitors (size 0603 or 0805) minimize lead inductances of bypass capacitors in high-speed environments, because their lead inductance is about 1 nH. For comparison purposes, a typical capacitor with leads has a lead inductance around 5 nH.

The value of the bypass capacitors used locally with LVDS chips can be determined by the following formula according to Johnson, equations 8.18 to 8.21. A conservative rise time of 200 ps and a worst-case change in supply current of 1 A covers the whole range of LVDS devices offered by Texas Instruments. In this example, the maximum power supply noise tolerated is 200 mV; however, this figure varies depending on the noise budget available in your design. <sup>(1)</sup>

$$C_{\text{chip}} = \left( \frac{\Delta I_{\text{Maximum Step Change Supply Current}}}{\Delta V_{\text{Maximum Power Supply Noise}}} \right) \times T_{\text{Rise Time}} \quad (1)$$

$$C_{\text{LVDS}} = \left( \frac{1\text{A}}{0.2\text{V}} \right) \times 200 \text{ ps} = 0.001 \mu\text{F} \quad (2)$$

The following example lowers lead inductance and covers intermediate frequencies between the board-level capacitor (>10  $\mu\text{F}$ ) and the value of capacitance found above (0.001  $\mu\text{F}$ ). You should place the smallest value of capacitance as close as possible to the chip.



**Figure 11. Recommended LVDS Bypass Capacitor Layout**

#### 10.2.1.2.3 Driver Output Voltage

The SNx5LVDSxx driver output is a 1.2-V common-mode voltage, with a nominal differential output signal of 340 mV. This 340 mV is the absolute value of the differential swing ( $V_{\text{OD}} = |V^+ - V^-|$ ). The peak-to-peak differential voltage is twice this value, or 680 mV.

#### 10.2.1.2.4 Interconnecting Media

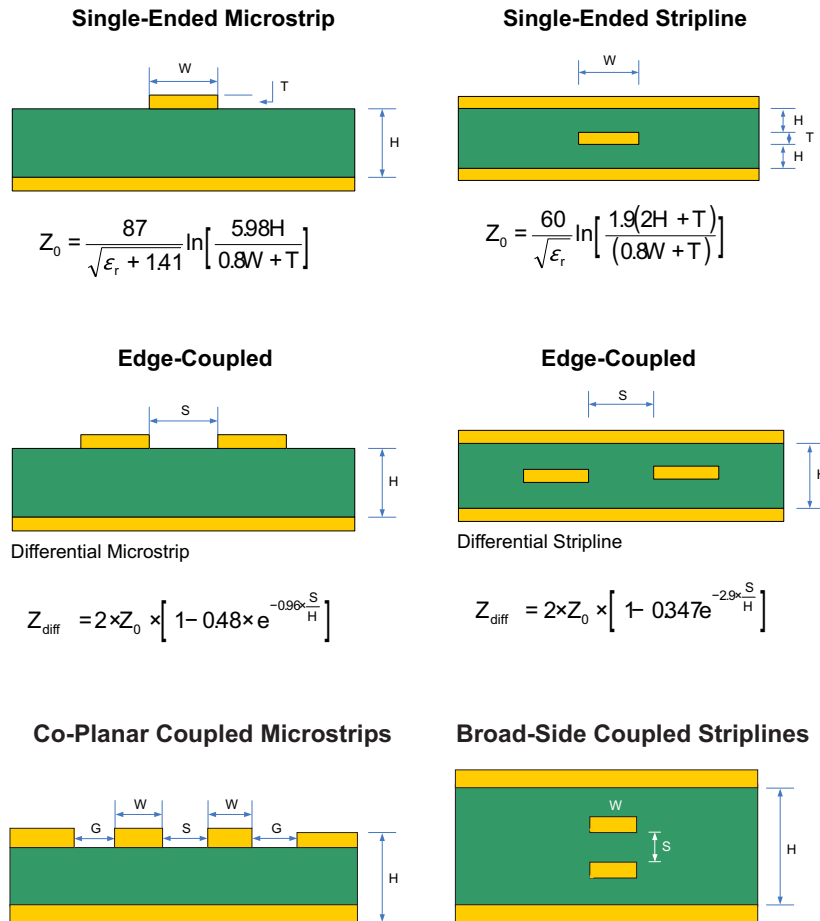
The physical communication channel between the driver and the receiver may be any balanced paired metal conductors meeting the requirements of the LVDS standard, the key points which will be included here. This media may be a twisted pair, twinax, flat ribbon cable, or PCB traces. The nominal characteristic impedance of the interconnect should be between 100  $\Omega$  and 120  $\Omega$  with a variation of no more than 10% (90  $\Omega$  to 132  $\Omega$ ).

#### 10.2.1.2.5 PCB Transmission Lines

As per [SNLA187](#), [Figure 12](#) depicts several transmission line structures commonly used in printed-circuit boards (PCBs). Each structure consists of a signal line and a return path with uniform cross-section along its length. A microstrip is a signal trace on the top (or bottom) layer, separated by a dielectric layer from its return path in a ground or power plane. A stripline is a signal trace in the inner layer, with a dielectric layer in between a ground plane above and below the signal trace. The dimensions of the structure along with the dielectric material properties determine the characteristic impedance of the transmission line (also called controlled-impedance transmission line).

When two signal lines are placed close by, they form a pair of coupled transmission lines. [Figure 12](#) shows examples of edge-coupled microstrips, and edge-coupled or broad-side-coupled striplines. When excited by differential signals, the coupled transmission line is referred to as a differential pair. The characteristic impedance of each line is called odd-mode impedance. The sum of the odd-mode impedances of each line is the differential impedance of the differential pair. In addition to the trace dimensions and dielectric material properties, the spacing between the two traces determines the mutual coupling and impacts the differential impedance. When the two lines are immediately adjacent; for example,  $S$  is less than  $2W$ , the differential pair is called a tightly-coupled differential pair. To maintain constant differential impedance along the length, it is important to keep the trace width and spacing uniform along the length, as well as maintain good symmetry between the two lines.

(1) Howard Johnson & Martin Graham. 1993. High Speed Digital Design – A Handbook of Black Magic. Prentice Hall PRT. ISBN number 013395724.


**Figure 12. Controlled-Impedance Transmission Lines**

#### 10.2.1.2.6 Termination Resistor

As shown earlier, an LVDS communication channel employs a current source driving a transmission line which is terminated with a resistive load. This load serves to convert the transmitted current into a voltage at the receiver input. To ensure incident wave switching (which is necessary to operate the channel at the highest signaling rate), the termination resistance should be matched to the characteristic impedance of the transmission line. The designer should ensure that the termination resistance is within 10% of the nominal media characteristic impedance. If the transmission line is targeted for 100-Ω impedance, the termination resistance should be between 90 and 110 Ω.

The line termination resistance should be located as close as possible to the receiver, thereby minimizing the stub length from the resistor to the receiver. The limiting case would be to incorporate the termination resistor into the receiver, which is exactly what is offered with a device like the SN65LVDT386. The SN65LVDT386 provides all the functionality and performance of the SN65LVDT386 receiver, with the added feature of an integrated termination load.

While we talk in this section about point-to-point communications, a word of caution is useful when a multidrop topology is used. In such topologies, line termination resistors are to be located only at the end(s) of the transmission line. In such an environment, SN65LVDT386 receivers could be used for loads branching off the main bus with an SN65LVDT386 used only at the bus end.

#### 10.2.1.2.7 Driver NC Pins

NC (not connected) pins are pins where the die is not physically connected to the lead frame and package. For optimum thermal performance, a good rule of thumb is to ground the NC pins at the board level.

### 10.2.1.3 Application Curve

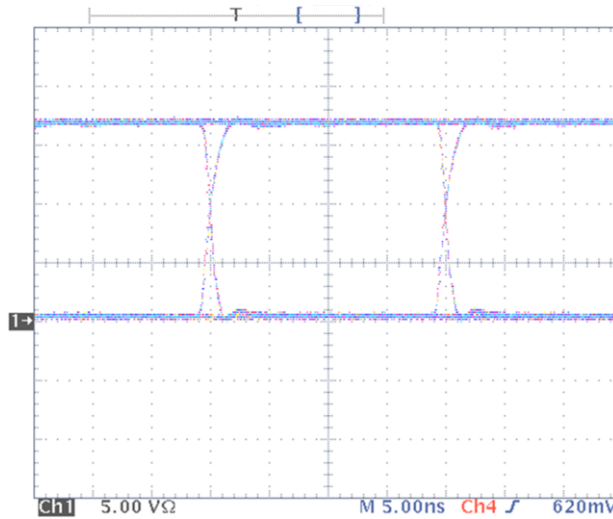


Figure 13. Typical Driver Output Eye Pattern in Point-to-Point System

### 10.2.2 Multidrop Communications

A second common application of LVDS buffers is a multidrop topology. In a multidrop configuration, a single driver and a shared bus are present along with two or more receivers (with a maximum permissible number of 32 receivers). Figure 14 shows an example of a multidrop system.

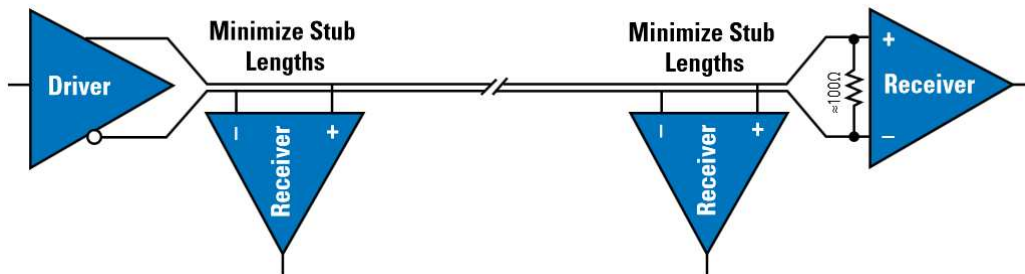


Figure 14. Multidrop Topology

#### 10.2.2.1 Design Requirements

DESIGN PARAMETERS	EXAMPLE VALUE
Driver Supply Voltage ( $V_{CCD}$ )	3.0 to 3.6 V
Driver Input Voltage	0.8 to 3.3 V
Driver Signaling Rate	DC to 400 Mbps
Interconnect Characteristic Impedance	100 $\Omega$
Termination Resistance	100 $\Omega$
Number of Receiver Nodes	2 to 32
Receiver Supply Voltage ( $V_{CCR}$ )	3.0 to 3.6 V
Receiver Input Voltage	0 to 2.4 V
Receiver Signaling Rate	DC to 400 Mbps
Ground shift between driver and receiver	$\pm 1$ V

### 10.2.2.2 Detailed Design Procedure

#### 10.2.2.2.1 Interconnecting Media

The interconnect in a multidrop system differs considerably from a point-to-point system. While point-to-point interconnects are straightforward and well understood, the bus type architecture encountered with multidrop systems requires more careful attention. We will use Figure 14 above to explore these details.

The most basic multidrop system would include a single driver, located at a bus origin, with multiple receiver nodes branching off the main line, and a final receiver at the end of the transmission line, co-located with a bus termination resistor. While this would be the most basic multidrop system, it has several considerations not yet explored.

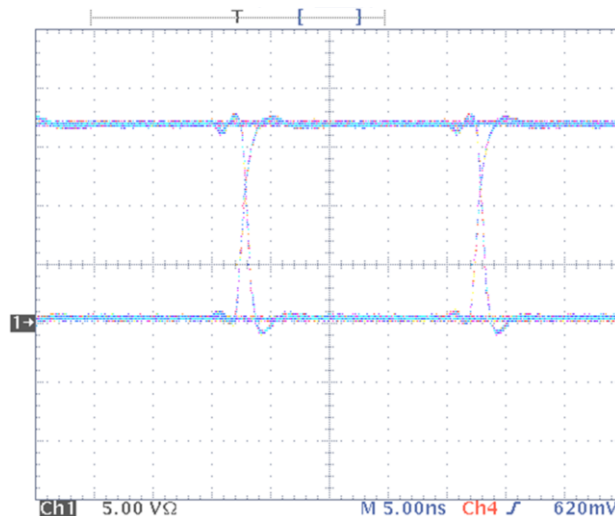
The location of the transmitter at one bus end allows the design concerns to be simplified, but this comes at the cost of flexibility. With a transmitter located at the origin, a single bus termination at the far-end is required. The far-end termination absorbs the incident traveling wave. The flexibility lost with this arrangement is thus: if the single transmitter needed to be relocated on the bus, at any location other than the origin, we would be faced with a bus with one open-circuited end, and one properly terminated end. Locating the transmitter say in the middle of the bus may be desired to reduce (by  $\frac{1}{2}$ ) the maximum flight time from the transmitter to receiver.

Another new feature in Figure 14 is clear in that every node branching off the main line results in stubs. The stubs should be minimized in any case, but have the unintended effect of locally changing the loaded impedance of the bus.

To a good approximation, the characteristic transmission line impedance seen into any cut point in the unloaded multipoint or multidrop bus is defined by  $\sqrt{L/C}$ , where L is the inductance per unit length and C is the capacitance per unit length. As capacitance is added to the bus in the form of devices and interconnections, the bus characteristic impedance is lowered. This may result in signal reflections from the impedance mismatch between the unloaded and loaded segments of the bus.

If the number of loads is constant and can be distributed evenly along the line, reflections can be reduced by changing the bus termination resistors to match the loaded characteristic impedance. Normally, the number of loads are not constant or distributed evenly and the reflections resulting from any mismatching should be accounted for in the noise budget.

#### 10.2.2.3 Application Curve



**Figure 15. Typical Driver Output Eye Pattern in Multi-Drop System**

## 11 Power Supply Recommendations

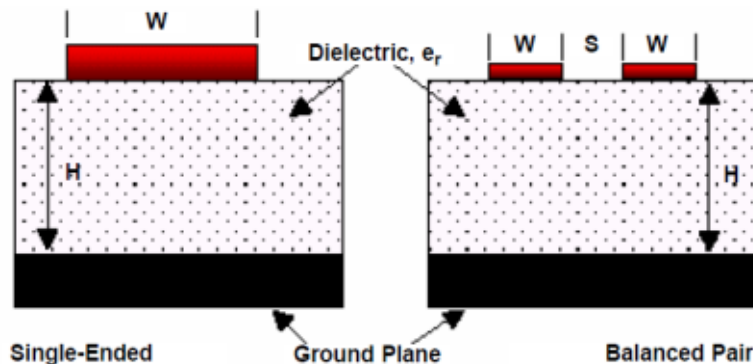
The LVDS drivers in this data sheet are designed to operate from a single power supply, with supply voltages in the range of 3.0 V to 3.6 V. In a typical application, a driver and a receiver may be on separate boards or even separate equipment. In these cases, separate supplies would be used at each location. The expected ground potential difference between the driver power supply and the receiver power supply would be less than  $|\pm 1\text{ V}|$ . Board-level and local device-level bypass capacitance should be used and are covered in [Driver Bypass Capacitance](#).

## 12 Layout

### 12.1 Layout Guidelines

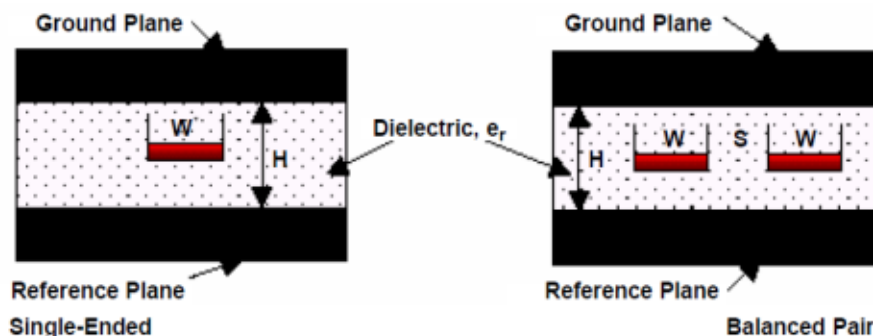
#### 12.1.1 Microstrip vs. Stripline Topologies

As per [SLLD009](#), printed-circuit boards usually offer designers two transmission line options: Microstrip and stripline. Microstrips are traces on the outer layer of a PCB, as shown in [Figure 16](#).



**Figure 16. Microstrip Topology**

On the other hand, striplines are traces between two ground planes. Striplines are less prone to emissions and susceptibility problems because the reference planes effectively shield the embedded traces. However, from the standpoint of high-speed transmission, juxtaposing two planes creates additional capacitance. TI recommends routing LVDS signals on microstrip transmission lines, if possible. The PCB traces allow designers to specify the necessary tolerances for  $Z_0$  based on the overall noise budget and reflection allowances. Footnotes 1, 2, and 3 provide formulas for  $Z_0$  and  $t_{PD}$  for differential and single-ended traces. <sup>(1)</sup> <sup>(2)</sup> <sup>(3)</sup>



**Figure 17. Stripline Topology**

- (1) Howard Johnson & Martin Graham.1993. High Speed Digital Design – A Handbook of Black Magic. Prentice Hall PRT. ISBN number 013395724.
- (2) Mark I. Montrose. 1996. Printed Circuit Board Design Techniques for EMC Compliance. IEEE Press. ISBN number 0780311310.
- (3) Clyde F. Coombs, Jr. Ed, Printed Circuits Handbook, McGraw Hill, ISBN number 0070127549.

## Layout Guidelines (continued)

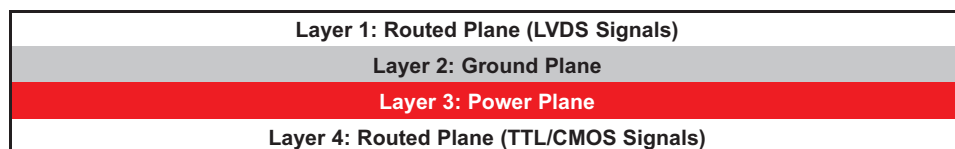
### 12.1.2 Dielectric Type and Board Construction

The speeds at which signals travel across the board dictates the choice of dielectric. FR-4, or equivalent, usually provides adequate performance for use with LVDS signals. If rise or fall times of TTL/CMOS signals are less than 500 ps, empirical results indicate that a material with a dielectric constant near 3.4, such as Rogers™ 4350 or Nelco N4000-13 is better suited. Once the designer chooses the dielectric, there are several parameters pertaining to the board construction that can affect performance. The following set of guidelines were developed experimentally through several designs involving LVDS devices:

- Copper weight: 15 g or 1/2 oz start, plated to 30 g or 1 oz
- All exposed circuitry should be solder-plated (60/40) to 7.62  $\mu\text{m}$  or 0.0003 in (minimum).
- Copper plating should be 25.4  $\mu\text{m}$  or 0.001 in (minimum) in plated-through-holes.
- Solder mask over bare copper with solder hot-air leveling

### 12.1.3 Recommended Stack Layout

Following the choice of dielectrics and design specifications, you should decide how many levels to use in the stack. To reduce the TTL/CMOS to LVDS crosstalk, it is a good practice to have at least two separate signal planes as shown in [Figure 18](#).

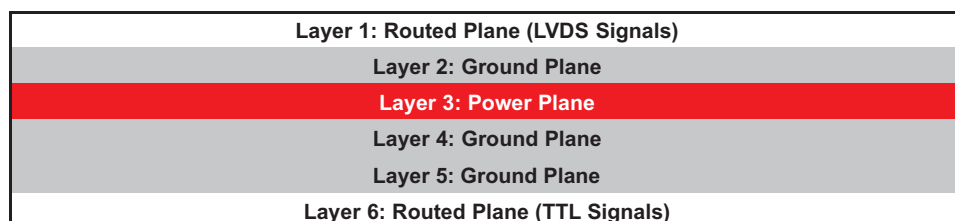


**Figure 18. Four-Layer PCB Board**

#### NOTE

The separation between layers 2 and 3 should be 127  $\mu\text{m}$  (0.005 in). By keeping the power and ground planes tightly coupled, the increased capacitance acts as a bypass for transients.

One of the most common stack configurations is the six-layer board, as shown in [Figure 19](#).



**Figure 19. Six-Layer PCB Board**

In this particular configuration, it is possible to isolate each signal layer from the power plane by at least one ground plane. The result is improved signal integrity; however, fabrication is more expensive. Using the 6-layer board is preferable, because it offers the layout designer more flexibility in varying the distance between signal layers and referenced planes, in addition to ensuring reference to a ground plane for signal layers 1 and 6.

### 12.1.4 Separation Between Traces

The separation between traces depends on several factors; however, the amount of coupling that can be tolerated usually dictates the actual separation. Low-noise coupling requires close coupling between the differential pair of an LVDS link to benefit from the electromagnetic field cancellation. The traces should be 100- $\Omega$  differential and thus coupled in the manner that best fits this requirement. In addition, differential pairs should have the same electrical length to ensure that they are balanced, thus minimizing problems with skew and signal reflection.



### Layout Guidelines (continued)

In the case of two adjacent single-ended traces, one should use the 3-W rule, which stipulates that the distance between two traces should be greater than two times the width of a single trace, or three times its width measured from trace center to trace center. This increased separation effectively reduces the potential for crosstalk. The same rule should be applied to the separation between adjacent LVDS differential pairs, whether the traces are edge-coupled or broad-side-coupled.

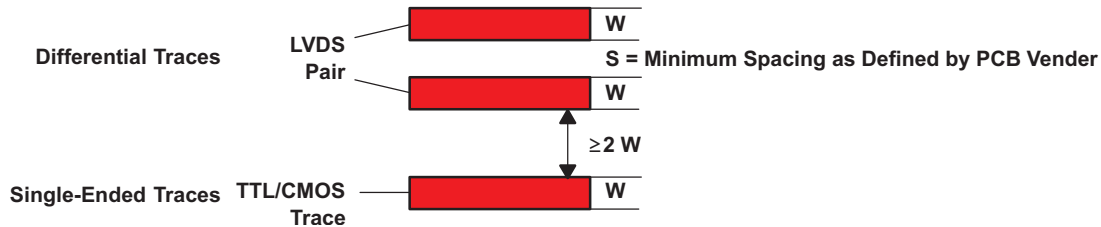


Figure 20. 3-W Rule for Single-Ended and Differential Traces (Top View)

You should exercise caution when using autorouters, because they do not always account for all factors affecting crosstalk and signal reflection. For instance, it is best to avoid sharp 90° turns to prevent discontinuities in the signal path. Using successive 45° turns tends to minimize reflections.

#### 12.1.5 Crosstalk and Ground Bounce Minimization

To reduce crosstalk, it is important to provide a return path to high-frequency currents that is as close as possible to its originating trace. A ground plane usually achieves this. Because the returning currents always choose the path of lowest inductance, they are most likely to return directly under the original trace, thus minimizing crosstalk. Lowering the area of the current loop lowers the potential for crosstalk. Traces kept as short as possible with an uninterrupted ground plane running beneath them emit the minimum amount of electromagnetic field strength. Discontinuities in the ground plane increase the return path inductance and should be avoided.

### 12.2 Layout Example

At least two or three times the width of an individual trace should separate single-ended traces and differential pairs to minimize the potential for crosstalk. Single-ended traces that run in parallel for less than the wavelength of the rise or fall times usually have negligible crosstalk. Increase the spacing between signal paths for long parallel runs to reduce crosstalk. Boards with limited real estate can benefit from the staggered trace layout, as shown in Figure 21.

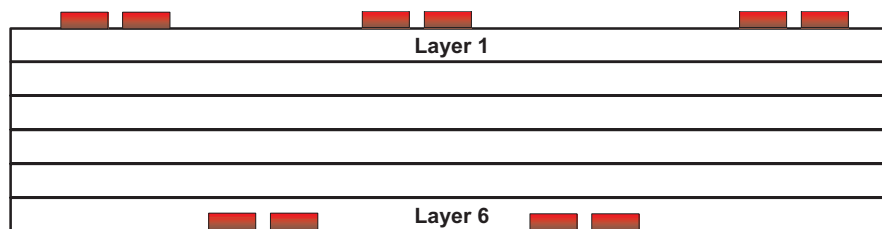
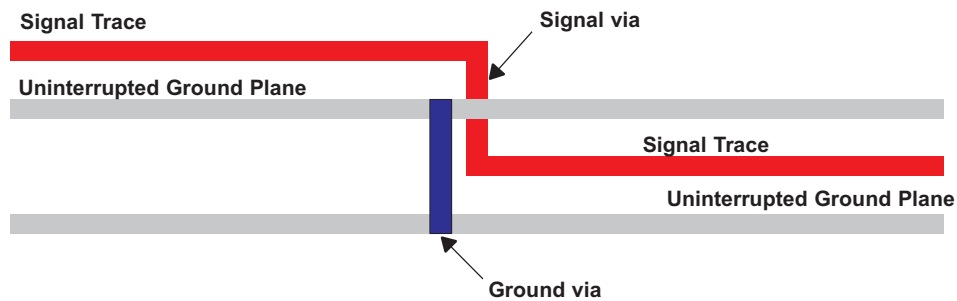


Figure 21. Staggered Trace Layout

This configuration lays out alternating signal traces on different layers; thus, the horizontal separation between traces can be less than 2 or 3 times the width of individual traces. To ensure continuity in the ground signal path, TI recommends having an adjacent ground via for every signal via, as shown in Figure 22. Note that vias create additional capacitance. For example, a typical via has a lumped capacitance effect of 0.5 pF to 1 pF in FR4.

**Layout Example (continued)**

**Figure 22. Ground Via Location (Side View)**

Short and low-impedance connection of the device ground pins to the PCB ground plane reduces ground bounce. Holes and cutouts in the ground planes can adversely affect current return paths if they create discontinuities that increase returning current loop areas.

To minimize EMI problems, TI recommends avoiding discontinuities below a trace (for example, holes, slits, and so on) and keeping traces as short as possible. Zoning the board wisely by placing all similar functions in the same area, as opposed to mixing them together, helps reduce susceptibility issues.

## 13 Device and Documentation Support

### 13.1 Device Support

#### 13.1.1 Third-Party Products Disclaimer

TI'S PUBLICATION OF INFORMATION REGARDING THIRD-PARTY PRODUCTS OR SERVICES DOES NOT CONSTITUTE AN ENDORSEMENT REGARDING THE SUITABILITY OF SUCH PRODUCTS OR SERVICES OR A WARRANTY, REPRESENTATION OR ENDORSEMENT OF SUCH PRODUCTS OR SERVICES, EITHER ALONE OR IN COMBINATION WITH ANY TI PRODUCT OR SERVICE.

#### 13.1.2 Other LVDS Products

For other products and application notes in the LVDS and LVDM product families visit our Web site at <http://www.ti.com/sc/datatran>.

### 13.2 Documentation Support

#### 13.2.1 Related Information

IBIS modeling is available for this device. Contact the local TI sales office or the TI Web site at [www.ti.com](http://www.ti.com) for more information.

For more application guidelines, see the following documents:

- *Low-Voltage Differential Signaling Design Notes* ([SLLA014](#))
- *Interface Circuits for TIA/EIA-644 (LVDS)* ([SLLA038](#))
- *Reducing EMI With LVDS* ([SLLA030](#))
- *Slew Rate Control of LVDS Circuits* ([SLLA034](#))
- *Using an LVDS Receiver With RS-422 Data* ([SLLA031](#))
- *Evaluating the LVDS EVM* ([SLLA033](#))

### 13.3 Related Links

[Table 4](#) lists quick access links. Categories include technical documents, support and community resources, tools and software, and quick access to sample or buy.

**Table 4. Related Links**

PARTS	PRODUCT FOLDER	SAMPLE & BUY	TECHNICAL DOCUMENTS	TOOLS & SOFTWARE	SUPPORT & COMMUNITY
SN55LVDS31	<a href="#">Click here</a>	<a href="#">Click here</a>	<a href="#">Click here</a>	<a href="#">Click here</a>	<a href="#">Click here</a>
SN65LVDS31	<a href="#">Click here</a>	<a href="#">Click here</a>	<a href="#">Click here</a>	<a href="#">Click here</a>	<a href="#">Click here</a>
SN65LVDS3487	<a href="#">Click here</a>	<a href="#">Click here</a>	<a href="#">Click here</a>	<a href="#">Click here</a>	<a href="#">Click here</a>
SN65LVDS9638	<a href="#">Click here</a>	<a href="#">Click here</a>	<a href="#">Click here</a>	<a href="#">Click here</a>	<a href="#">Click here</a>

### 13.4 Trademarks

PowerPAD is a trademark of Texas Instruments.

Rogers is a trademark of Rogers Corporation.

All other trademarks are the property of their respective owners.

### 13.5 Electrostatic Discharge Caution



These devices have limited built-in ESD protection. The leads should be shorted together or the device placed in conductive foam during storage or handling to prevent electrostatic damage to the MOS gates.

### 13.6 Glossary

[SLYZ022](#) — *TI Glossary*.

This glossary lists and explains terms, acronyms, and definitions.

## 14 Mechanical, Packaging, and Orderable Information

The following pages include mechanical, packaging, and orderable information. This information is the most current data available for the designated devices. This data is subject to change without notice and revision of this document. For browser-based versions of this data sheet, refer to the left-hand navigation.

**PACKAGING INFORMATION**

Orderable Device	Status (1)	Package Type	Package Drawing	Pins	Package Qty	Eco Plan (2)	Lead/Ball Finish (6)	MSL Peak Temp (3)	Op Temp (°C)	Device Marking (4/5)	Samples
5962-9762101Q2A	ACTIVE	LCCC	FK	20	1	TBD	POST-PLATE	N / A for Pkg Type	-55 to 125	5962- 9762101Q2A SNJ55 LVDS31FK	<a href="#">Samples</a>
5962-9762101QEA	ACTIVE	CDIP	J	16	1	TBD	A42	N / A for Pkg Type	-55 to 125	5962-9762101QE A SNJ55LVDS31J	<a href="#">Samples</a>
5962-9762101QFA	ACTIVE	CFP	W	16	1	TBD	A42	N / A for Pkg Type	-55 to 125	5962-9762101QF A SNJ55LVDS31W	<a href="#">Samples</a>
SN55LVDS31W	ACTIVE	CFP	W	16	1	TBD	A42	N / A for Pkg Type	-55 to 125	SN55LVDS31W	<a href="#">Samples</a>
SN65LVDS31D	ACTIVE	SOIC	D	16	40	Green (RoHS & no Sb/Br)	CU NIPDAU	Level-1-260C-UNLIM	-40 to 85	LVDS31	<a href="#">Samples</a>
SN65LVDS31DG4	ACTIVE	SOIC	D	16	40	Green (RoHS & no Sb/Br)	CU NIPDAU	Level-1-260C-UNLIM	-40 to 85	LVDS31	<a href="#">Samples</a>
SN65LVDS31DR	ACTIVE	SOIC	D	16	2500	Green (RoHS & no Sb/Br)	CU NIPDAU	Level-1-260C-UNLIM	-40 to 85	LVDS31	<a href="#">Samples</a>
SN65LVDS31DRG4	ACTIVE	SOIC	D	16	2500	Green (RoHS & no Sb/Br)	CU NIPDAU	Level-1-260C-UNLIM	-40 to 85	LVDS31	<a href="#">Samples</a>
SN65LVDS31NSR	ACTIVE	SO	NS	16	2000	TBD	Call TI	Call TI	-40 to 85	LVDS31	<a href="#">Samples</a>
SN65LVDS31PW	ACTIVE	TSSOP	PW	16	90	Green (RoHS & no Sb/Br)	CU NIPDAU	Level-1-260C-UNLIM	-40 to 85	LVDS31	<a href="#">Samples</a>
SN65LVDS31PWG4	ACTIVE	TSSOP	PW	16	90	Green (RoHS & no Sb/Br)	CU NIPDAU	Level-1-260C-UNLIM	-40 to 85	LVDS31	<a href="#">Samples</a>
SN65LVDS31PWR	ACTIVE	TSSOP	PW	16	2000	Green (RoHS & no Sb/Br)	CU NIPDAU	Level-1-260C-UNLIM	-40 to 85	LVDS31	<a href="#">Samples</a>
SN65LVDS31PWRG4	ACTIVE	TSSOP	PW	16	2000	Green (RoHS & no Sb/Br)	CU NIPDAU	Level-1-260C-UNLIM	-40 to 85	LVDS31	<a href="#">Samples</a>
SN65LVDS31QPWQ1	OBSOLETE	TSSOP	PW	16		TBD	Call TI	Call TI	-40 to 125		
SN65LVDS31QPWRQ1	OBSOLETE	TSSOP	PW	16		TBD	Call TI	Call TI	-40 to 125		
SN65LVDS3487D	ACTIVE	SOIC	D	16	40	Green (RoHS & no Sb/Br)	CU NIPDAU	Level-1-260C-UNLIM	-40 to 85	LVDS3487	<a href="#">Samples</a>

Orderable Device	Status (1)	Package Type	Package Drawing	Pins	Package Qty	Eco Plan (2)	Lead/Ball Finish (6)	MSL Peak Temp (3)	Op Temp (°C)	Device Marking (4/5)	Samples
SN65LVDS3487DG4	ACTIVE	SOIC	D	16	40	Green (RoHS & no Sb/Br)	CU NIPDAU	Level-1-260C-UNLIM	-40 to 85	LVDS3487	<a href="#">Samples</a>
SN65LVDS3487DR	ACTIVE	SOIC	D	16	2500	Green (RoHS & no Sb/Br)	CU NIPDAU	Level-1-260C-UNLIM	-40 to 85	LVDS3487	<a href="#">Samples</a>
SN65LVDS3487DRG4	ACTIVE	SOIC	D	16	2500	Green (RoHS & no Sb/Br)	CU NIPDAU	Level-1-260C-UNLIM	-40 to 85	LVDS3487	<a href="#">Samples</a>
SN65LVDS9638D	ACTIVE	SOIC	D	8	75	Green (RoHS & no Sb/Br)	CU NIPDAU	Level-1-260C-UNLIM	-40 to 85	DK638	<a href="#">Samples</a>
SN65LVDS9638DG4	ACTIVE	SOIC	D	8	75	Green (RoHS & no Sb/Br)	CU NIPDAU	Level-1-260C-UNLIM	-40 to 85	DK638	<a href="#">Samples</a>
SN65LVDS9638DGK	ACTIVE	VSSOP	DGK	8	80	Green (RoHS & no Sb/Br)	CU NIPDAU	Level-1-260C-UNLIM	-40 to 85	AXG	<a href="#">Samples</a>
SN65LVDS9638DGKG4	ACTIVE	VSSOP	DGK	8	80	Green (RoHS & no Sb/Br)	CU NIPDAU	Level-1-260C-UNLIM	-40 to 85	AXG	<a href="#">Samples</a>
SN65LVDS9638DGKR	ACTIVE	VSSOP	DGK	8	2500	Green (RoHS & no Sb/Br)	CU NIPDAU	Level-1-260C-UNLIM	-40 to 85	AXG	<a href="#">Samples</a>
SN65LVDS9638DGKRG4	ACTIVE	VSSOP	DGK	8	2500	Green (RoHS & no Sb/Br)	CU NIPDAU	Level-1-260C-UNLIM	-40 to 85	AXG	<a href="#">Samples</a>
SN65LVDS9638DGN	ACTIVE	MSOP-PowerPAD	DGN	8	80	Green (RoHS & no Sb/Br)	CU NIPDAU	Level-1-260C-UNLIM	-40 to 85	L38	<a href="#">Samples</a>
SN65LVDS9638DGNR	ACTIVE	MSOP-PowerPAD	DGN	8	2500	Green (RoHS & no Sb/Br)	CU NIPDAU	Level-1-260C-UNLIM	-40 to 85	L38	<a href="#">Samples</a>
SN65LVDS9638DGNRG4	ACTIVE	MSOP-PowerPAD	DGN	8	2500	Green (RoHS & no Sb/Br)	CU NIPDAU	Level-1-260C-UNLIM	-40 to 85	L38	<a href="#">Samples</a>
SN65LVDS9638DR	ACTIVE	SOIC	D	8	2500	Green (RoHS & no Sb/Br)	CU NIPDAU	Level-1-260C-UNLIM	-40 to 85	DK638	<a href="#">Samples</a>
SN65LVDS9638DRG4	ACTIVE	SOIC	D	8	2500	Green (RoHS & no Sb/Br)	CU NIPDAU	Level-1-260C-UNLIM	-40 to 85	DK638	<a href="#">Samples</a>
SNJ55LVDS31FK	ACTIVE	LCCC	FK	20	1	TBD	POST-PLATE	N / A for Pkg Type	-55 to 125	5962-9762101Q2A SNJ55 LVDS31FK	<a href="#">Samples</a>
SNJ55LVDS31J	ACTIVE	CDIP	J	16	1	TBD	A42	N / A for Pkg Type	-55 to 125	5962-9762101QE A SNJ55LVDS31J	<a href="#">Samples</a>
SNJ55LVDS31W	ACTIVE	CFP	W	16	1	TBD	A42	N / A for Pkg Type	-55 to 125	5962-9762101QF A	<a href="#">Samples</a>

Orderable Device	Status (1)	Package Type	Package Drawing	Pins	Package Qty	Eco Plan (2)	Lead/Ball Finish (6)	MSL Peak Temp (3)	Op Temp (°C)	Device Marking (4/5)	Samples
										SNJ55LVDS31W	

(1) The marketing status values are defined as follows:

**ACTIVE:** Product device recommended for new designs.

**LIFEBUY:** TI has announced that the device will be discontinued, and a lifetime-buy period is in effect.

**NRND:** Not recommended for new designs. Device is in production to support existing customers, but TI does not recommend using this part in a new design.

**PREVIEW:** Device has been announced but is not in production. Samples may or may not be available.

**OBSOLETE:** TI has discontinued the production of the device.

(2) Eco Plan - The planned eco-friendly classification: Pb-Free (RoHS), Pb-Free (RoHS Exempt), or Green (RoHS & no Sb/Br) - please check <http://www.ti.com/productcontent> for the latest availability information and additional product content details.

**TBD:** The Pb-Free/Green conversion plan has not been defined.

**Pb-Free (RoHS):** TI's terms "Lead-Free" or "Pb-Free" mean semiconductor products that are compatible with the current RoHS requirements for all 6 substances, including the requirement that lead not exceed 0.1% by weight in homogeneous materials. Where designed to be soldered at high temperatures, TI Pb-Free products are suitable for use in specified lead-free processes.

**Pb-Free (RoHS Exempt):** This component has a RoHS exemption for either 1) lead-based flip-chip solder bumps used between the die and package, or 2) lead-based die adhesive used between the die and leadframe. The component is otherwise considered Pb-Free (RoHS compatible) as defined above.

**Green (RoHS & no Sb/Br):** TI defines "Green" to mean Pb-Free (RoHS compatible), and free of Bromine (Br) and Antimony (Sb) based flame retardants (Br or Sb do not exceed 0.1% by weight in homogeneous material)

(3) MSL, Peak Temp. - The Moisture Sensitivity Level rating according to the JEDEC industry standard classifications, and peak solder temperature.

(4) There may be additional marking, which relates to the logo, the lot trace code information, or the environmental category on the device.

(5) Multiple Device Markings will be inside parentheses. Only one Device Marking contained in parentheses and separated by a "~" will appear on a device. If a line is indented then it is a continuation of the previous line and the two combined represent the entire Device Marking for that device.

(6) Lead/Ball Finish - Orderable Devices may have multiple material finish options. Finish options are separated by a vertical ruled line. Lead/Ball Finish values may wrap to two lines if the finish value exceeds the maximum column width.

**Important Information and Disclaimer:** The information provided on this page represents TI's knowledge and belief as of the date that it is provided. TI bases its knowledge and belief on information provided by third parties, and makes no representation or warranty as to the accuracy of such information. Efforts are underway to better integrate information from third parties. TI has taken and continues to take reasonable steps to provide representative and accurate information but may not have conducted destructive testing or chemical analysis on incoming materials and chemicals. TI and TI suppliers consider certain information to be proprietary, and thus CAS numbers and other limited information may not be available for release.

In no event shall TI's liability arising out of such information exceed the total purchase price of the TI part(s) at issue in this document sold by TI to Customer on an annual basis.

**OTHER QUALIFIED VERSIONS OF SN55LVDS31, SN65LVDS31 :**

- Catalog: [SN75LVDS31](#)
- Enhanced Product: [SN65LVDS31-EP](#)
- Space: [SN55LVDS31-SP](#)

NOTE: Qualified Version Definitions:

- Catalog - TI's standard catalog product
- Enhanced Product - Supports Defense, Aerospace and Medical Applications
- Space - Radiation tolerant, ceramic packaging and qualified for use in Space-based application



**TAPE AND REEL INFORMATION**

**QUADRANT ASSIGNMENTS FOR PIN 1 ORIENTATION IN TAPE**


\*All dimensions are nominal

Device	Package Type	Package Drawing	Pins	SPQ	Reel Diameter (mm)	Reel Width W1 (mm)	A0 (mm)	B0 (mm)	K0 (mm)	P1 (mm)	W (mm)	Pin1 Quadrant
SN65LVDS31DR	SOIC	D	16	2500	330.0	16.4	6.5	10.3	2.1	8.0	16.0	Q1
SN65LVDS31PWR	TSSOP	PW	16	2000	330.0	12.4	6.9	5.6	1.6	8.0	12.0	Q1
SN65LVDS3487DR	SOIC	D	16	2500	330.0	16.4	6.5	10.3	2.1	8.0	16.0	Q1
SN65LVDS9638DGKR	VSSOP	DGK	8	2500	330.0	12.4	5.3	3.4	1.4	8.0	12.0	Q1
SN65LVDS9638DGNR	MSOP-Power PAD	DGN	8	2500	330.0	12.4	5.3	3.4	1.4	8.0	12.0	Q1
SN65LVDS9638DR	SOIC	D	8	2500	330.0	12.4	6.4	5.2	2.1	8.0	12.0	Q1
SN65LVDS9638DR	SOIC	D	8	2500	330.0	12.4	6.4	5.2	2.1	8.0	12.0	Q1

**TAPE AND REEL BOX DIMENSIONS**


\*All dimensions are nominal

Device	Package Type	Package Drawing	Pins	SPQ	Length (mm)	Width (mm)	Height (mm)
SN65LVDS31DR	SOIC	D	16	2500	333.2	345.9	28.6
SN65LVDS31PWR	TSSOP	PW	16	2000	367.0	367.0	35.0
SN65LVDS3487DR	SOIC	D	16	2500	367.0	367.0	38.0
SN65LVDS9638DGKR	VSSOP	DGK	8	2500	358.0	335.0	35.0
SN65LVDS9638DGNR	MSOP-PowerPAD	DGN	8	2500	358.0	335.0	35.0
SN65LVDS9638DR	SOIC	D	8	2500	367.0	367.0	35.0
SN65LVDS9638DR	SOIC	D	8	2500	340.5	338.1	20.6

J (R-GDIP-T\*\*)

14 LEADS SHOWN

CERAMIC DUAL IN-LINE PACKAGE



DIM \ PINS **	14	16	18	20
A	0.300 (7,62) BSC	0.300 (7,62) BSC	0.300 (7,62) BSC	0.300 (7,62) BSC
B MAX	0.785 (19,94)	.840 (21,34)	0.960 (24,38)	1.060 (26,92)
B MIN	—	—	—	—
C MAX	0.300 (7,62)	0.300 (7,62)	0.310 (7,87)	0.300 (7,62)
C MIN	0.245 (6,22)	0.245 (6,22)	0.220 (5,59)	0.245 (6,22)

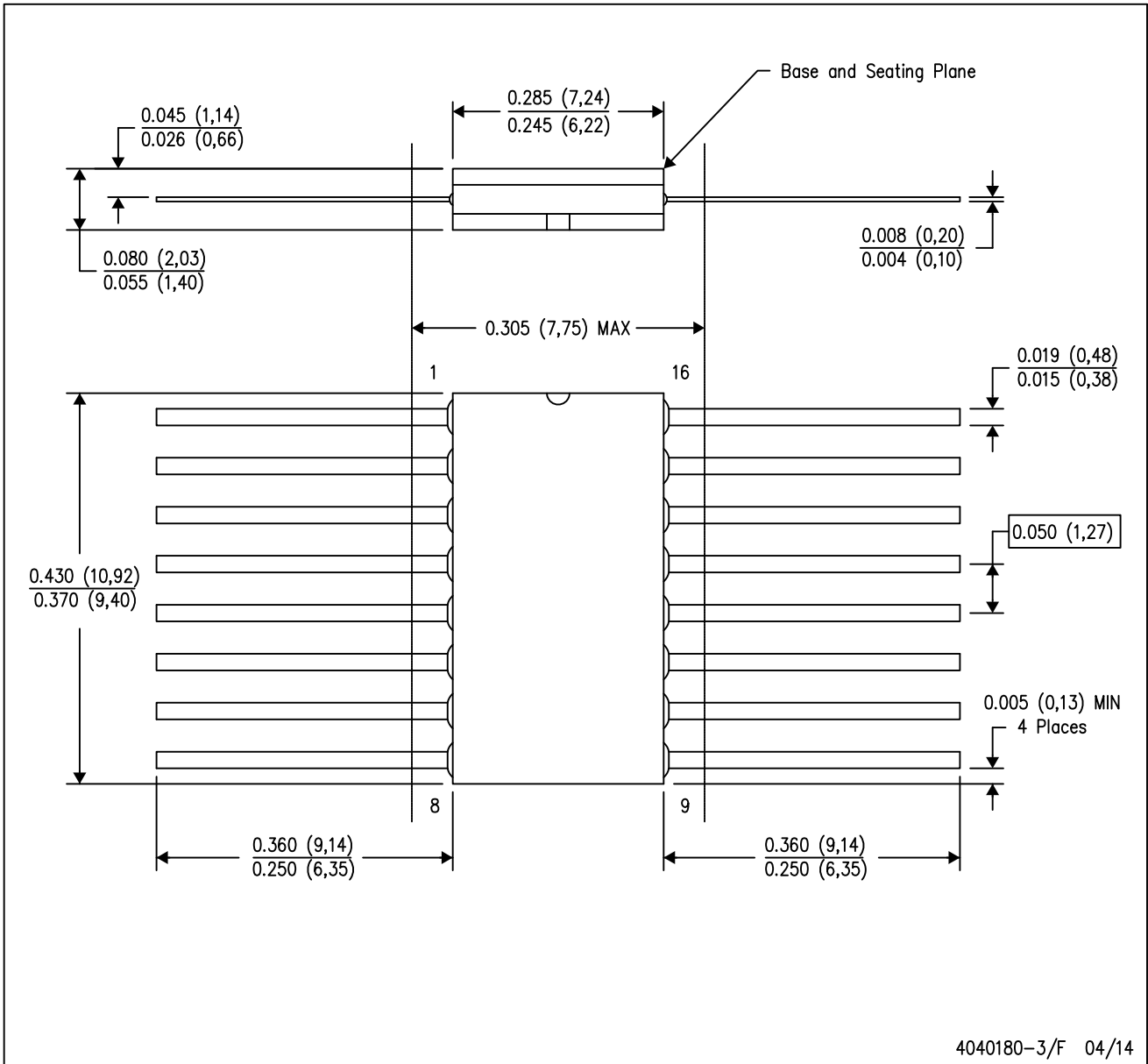


4040083/F 03/03

- NOTES:
- All linear dimensions are in inches (millimeters).
  - This drawing is subject to change without notice.
  - This package is hermetically sealed with a ceramic lid using glass frit.
  - Index point is provided on cap for terminal identification only on press ceramic glass frit seal only.
  - Falls within MIL STD 1835 GDIP1-T14, GDIP1-T16, GDIP1-T18 and GDIP1-T20.

W (R-GDFP-F16)

CERAMIC DUAL FLATPACK



- NOTES:
- A. All linear dimensions are in inches (millimeters).
  - B. This drawing is subject to change without notice.
  - C. This package can be hermetically sealed with a ceramic lid using glass frit.
  - D. Index point is provided on cap for terminal identification only.
  - E. Falls within MIL STD 1835 GDFP2-F16

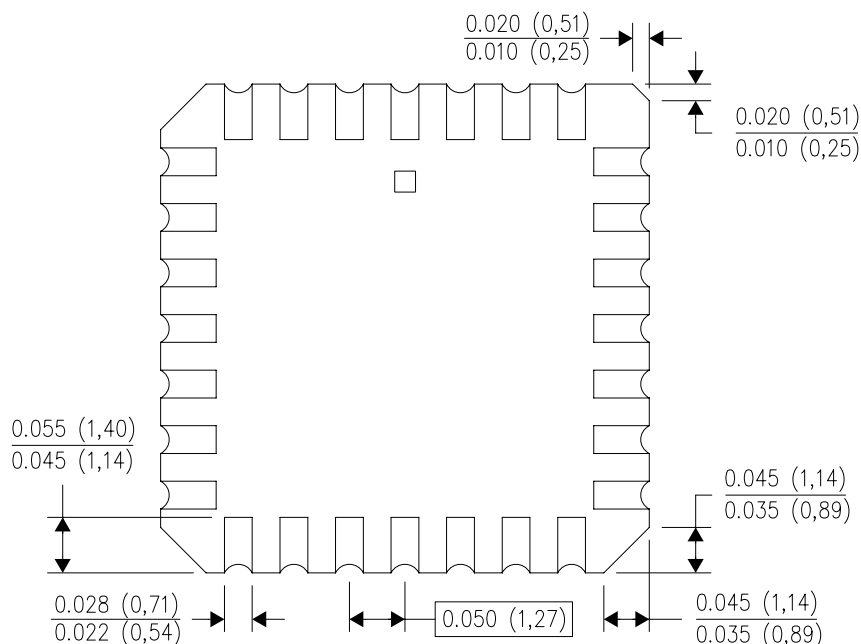
FK (S-CQCC-N\*\*)

LEADLESS CERAMIC CHIP CARRIER

28 TERMINAL SHOWN



NO. OF TERMINALS **	A		B	
	MIN	MAX	MIN	MAX
20	0.342 (8,69)	0.358 (9,09)	0.307 (7,80)	0.358 (9,09)
28	0.442 (11,23)	0.458 (11,63)	0.406 (10,31)	0.458 (11,63)
44	0.640 (16,26)	0.660 (16,76)	0.495 (12,58)	0.560 (14,22)
52	0.740 (18,78)	0.761 (19,32)	0.495 (12,58)	0.560 (14,22)
68	0.938 (23,83)	0.962 (24,43)	0.850 (21,6)	0.858 (21,8)
84	1.141 (28,99)	1.165 (29,59)	1.047 (26,6)	1.063 (27,0)



4040140/D 01/11

- NOTES:
- All linear dimensions are in inches (millimeters).
  - This drawing is subject to change without notice.
  - This package can be hermetically sealed with a metal lid.
  - Falls within JEDEC MS-004

DGK (S-PDSO-G8)

PLASTIC SMALL-OUTLINE PACKAGE



- NOTES:
- A. All linear dimensions are in millimeters.
  - B. This drawing is subject to change without notice.
  - C. Body length does not include mold flash, protrusions, or gate burrs. Mold flash, protrusions, or gate burrs shall not exceed 0.15 per end.
  - D. Body width does not include interlead flash. Interlead flash shall not exceed 0.50 per side.
  - E. Falls within JEDEC MO-187 variation AA, except interlead flash.

DGN (S-PDSO-G8)

PowerPAD™ PLASTIC SMALL OUTLINE



- NOTES:
- All linear dimensions are in millimeters.
  - This drawing is subject to change without notice.
  - Body dimensions do not include mold flash or protrusion.
  - This package is designed to be soldered to a thermal pad on the board. Refer to Technical Brief, PowerPad Thermally Enhanced Package, Texas Instruments Literature No. SLMA002 for information regarding recommended board layout. This document is available at [www.ti.com](http://www.ti.com) <<http://www.ti.com>>.
  - See the additional figure in the Product Data Sheet for details regarding the exposed thermal pad features and dimensions.
  - Falls within JEDEC MO-187 variation AA-T

PowerPAD is a trademark of Texas Instruments.

DGN (S-PDSO-G8)

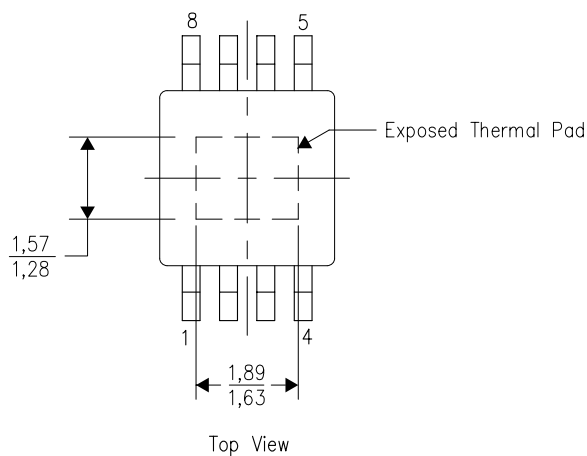
PowerPAD™ PLASTIC SMALL OUTLINE

## THERMAL INFORMATION

This PowerPAD™ package incorporates an exposed thermal pad that is designed to be attached to a printed circuit board (PCB). The thermal pad must be soldered directly to the PCB. After soldering, the PCB can be used as a heatsink. In addition, through the use of thermal vias, the thermal pad can be attached directly to the appropriate copper plane shown in the electrical schematic for the device, or alternatively, can be attached to a special heatsink structure designed into the PCB. This design optimizes the heat transfer from the integrated circuit (IC).

For additional information on the PowerPAD package and how to take advantage of its heat dissipating abilities, refer to Technical Brief, PowerPAD Thermally Enhanced Package, Texas Instruments Literature No. SLMA002 and Application Brief, PowerPAD Made Easy, Texas Instruments Literature No. SLMA004. Both documents are available at [www.ti.com](http://www.ti.com).

The exposed thermal pad dimensions for this package are shown in the following illustration.



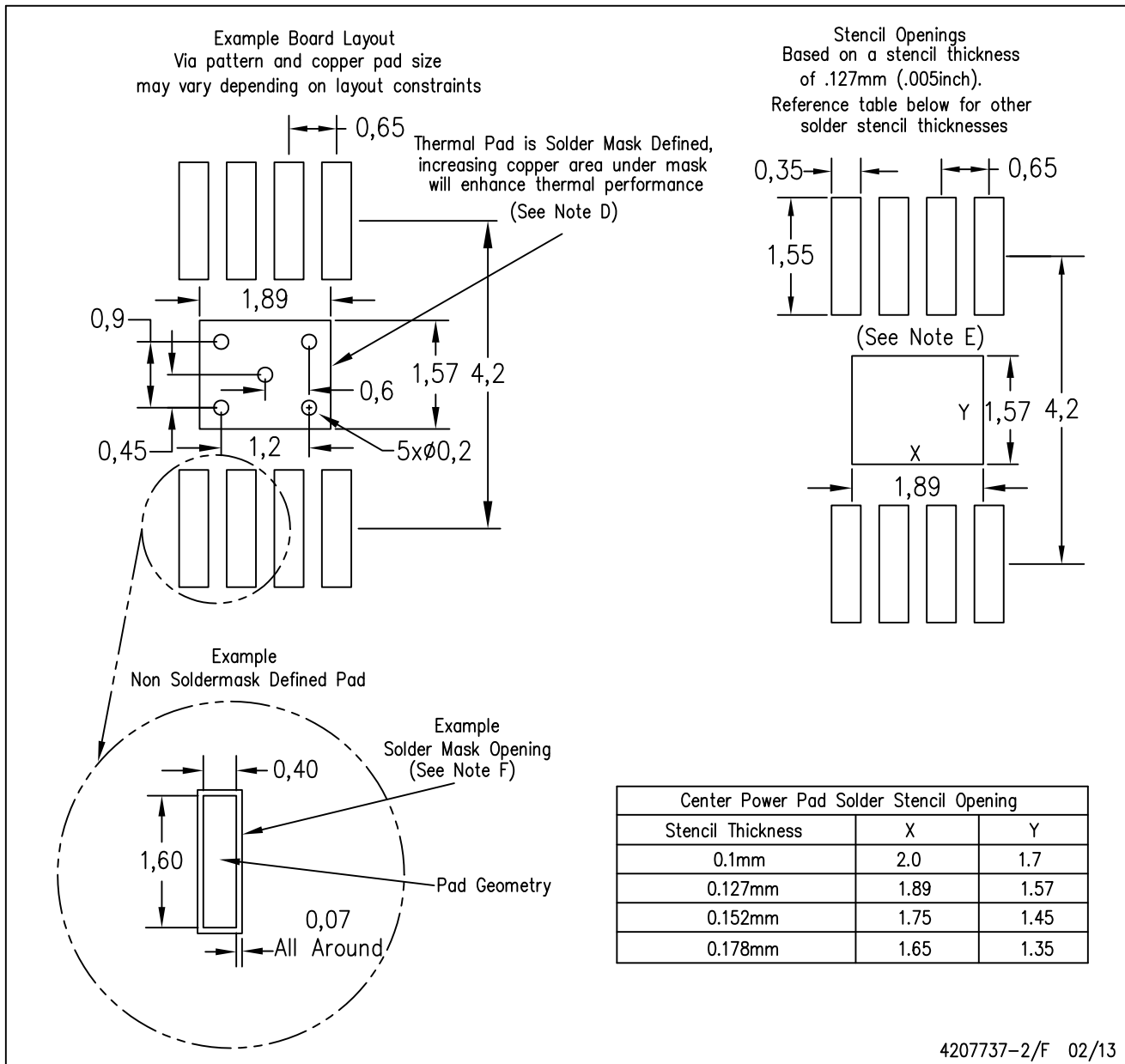
Exposed Thermal Pad Dimensions

4206323-2/1 12/11

NOTE: All linear dimensions are in millimeters

PowerPAD is a trademark of Texas Instruments





- NOTES:
- A. All linear dimensions are in millimeters.
  - B. This drawing is subject to change without notice.
  - C. Customers should place a note on the circuit board fabrication drawing not to alter the center solder mask defined pad.
  - D. This package is designed to be soldered to a thermal pad on the board. Refer to Technical Brief, PowerPad Thermally Enhanced Package, Texas Instruments Literature No. SLMA002, SLMA004, and also the Product Data Sheets for specific thermal information, via requirements, and recommended board layout. These documents are available at [www.ti.com](http://www.ti.com) <<http://www.ti.com>>.
  - E. Laser cutting apertures with trapezoidal walls and also rounding corners will offer better paste release. Customers should contact their board assembly site for stencil design recommendations. Example stencil design based on a 50% volumetric metal load solder paste. Refer to IPC-7525 for other stencil recommendations.
  - F. Customers should contact their board fabrication site for solder mask tolerances between and around signal pads.



PowerPAD is a trademark of Texas Instruments

D (R-PDSO-G16)

PLASTIC SMALL OUTLINE



4040047-6/M 06/11

- NOTES:
- A. All linear dimensions are in inches (millimeters).
  - B. This drawing is subject to change without notice.
  -  Body length does not include mold flash, protrusions, or gate burrs. Mold flash, protrusions, or gate burrs shall not exceed 0.006 (0,15) each side.
  -  Body width does not include interlead flash. Interlead flash shall not exceed 0.017 (0,43) each side.
  - E. Reference JEDEC MS-012 variation AC.

D (R-PDSO-G16)

PLASTIC SMALL OUTLINE



- NOTES:
- A. All linear dimensions are in millimeters.
  - B. This drawing is subject to change without notice.
  - C. Publication IPC-7351 is recommended for alternate designs.
  - D. Laser cutting apertures with trapezoidal walls and also rounding corners will offer better paste release. Customers should contact their board assembly site for stencil design recommendations. Refer to IPC-7525 for other stencil recommendations.
  - E. Customers should contact their board fabrication site for solder mask tolerances between and around signal pads.

PW (R-PDSO-G16)

PLASTIC SMALL OUTLINE

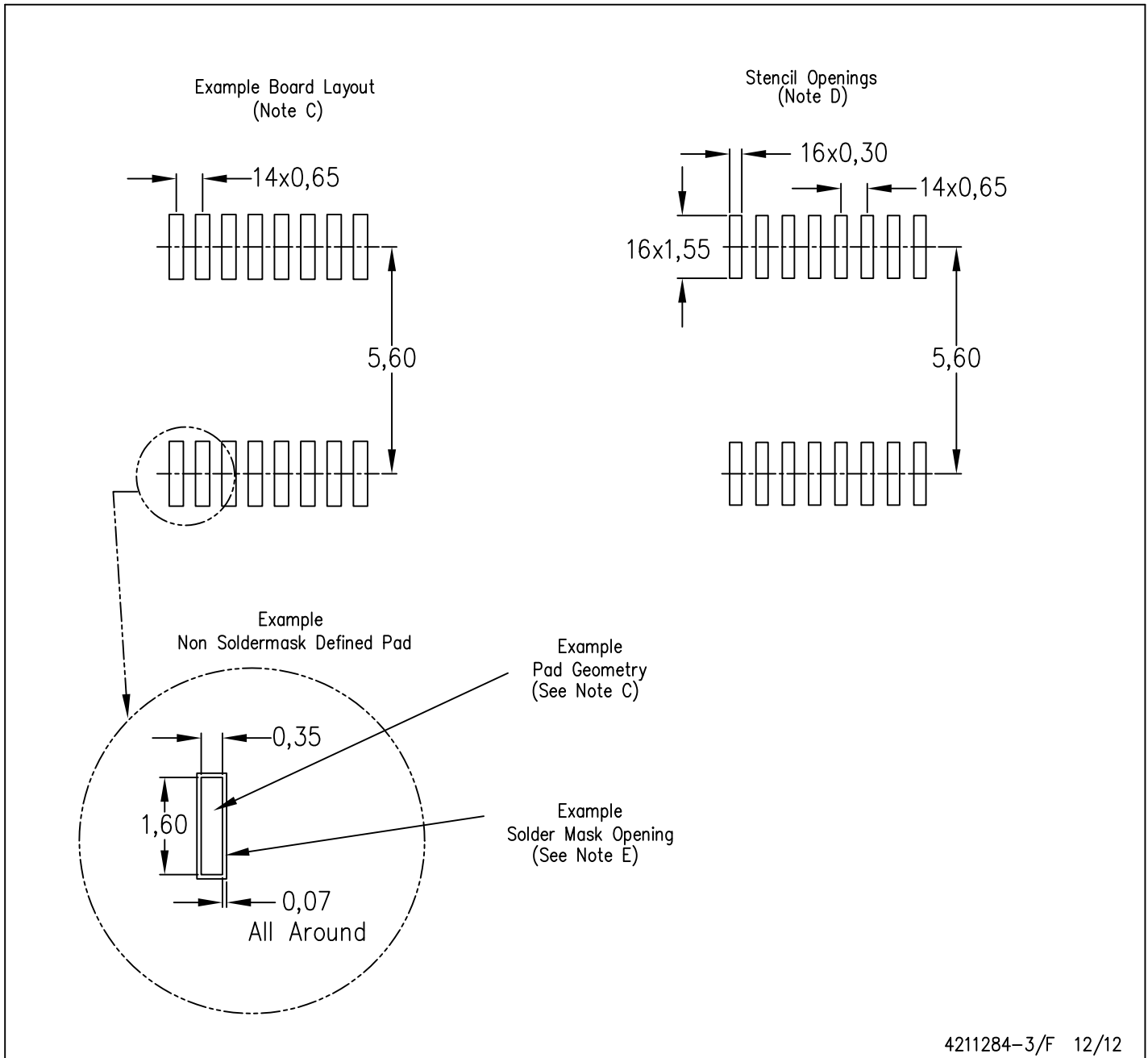


4040064-4/G 02/11

- NOTES:
- A. All linear dimensions are in millimeters. Dimensioning and tolerancing per ASME Y14.5M-1994.
  - B. This drawing is subject to change without notice.
  - C. Body length does not include mold flash, protrusions, or gate burrs. Mold flash, protrusions, or gate burrs shall not exceed 0,15 each side.
  - D. Body width does not include interlead flash. Interlead flash shall not exceed 0,25 each side.
  - E. Falls within JEDEC MO-153

PW (R-PDSO-G16)

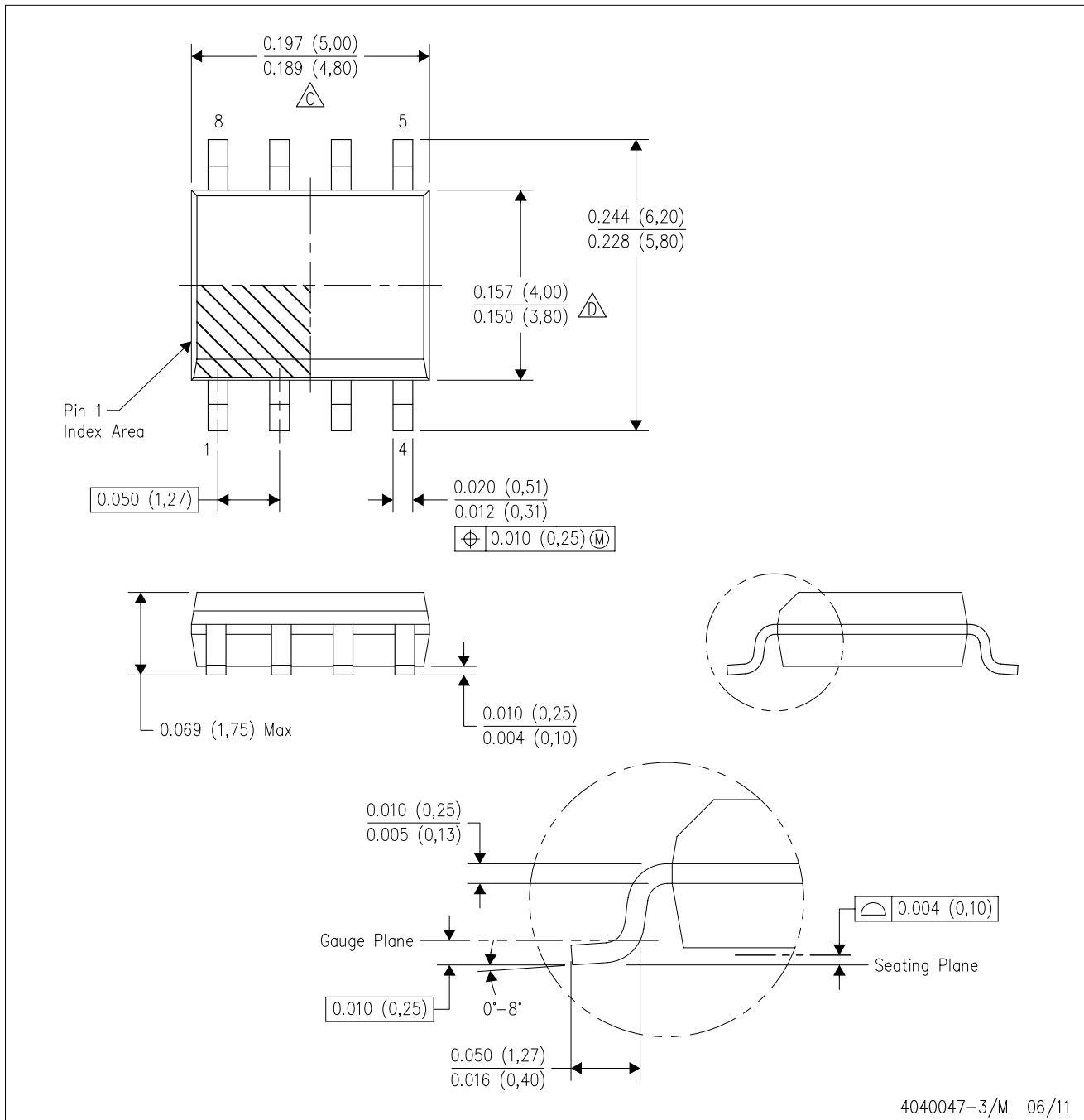
PLASTIC SMALL OUTLINE



- NOTES:
- All linear dimensions are in millimeters.
  - This drawing is subject to change without notice.
  - Publication IPC-7351 is recommended for alternate designs.
  - Laser cutting apertures with trapezoidal walls and also rounding corners will offer better paste release. Customers should contact their board assembly site for stencil design recommendations. Refer to IPC-7525 for other stencil recommendations.
  - Customers should contact their board fabrication site for solder mask tolerances between and around signal pads.

D (R-PDSO-G8)

PLASTIC SMALL OUTLINE



D (R-PDSO-G8)

PLASTIC SMALL OUTLINE



- NOTES:
- A. All linear dimensions are in millimeters.
  - B. This drawing is subject to change without notice.
  - C. Publication IPC-7351 is recommended for alternate designs.
  - D. Laser cutting apertures with trapezoidal walls and also rounding corners will offer better paste release. Customers should contact their board assembly site for stencil design recommendations. Refer to IPC-7525 for other stencil recommendations.
  - E. Customers should contact their board fabrication site for solder mask tolerances between and around signal pads.

## MECHANICAL DATA

NS (R-PDSO-G\*\*)

PLASTIC SMALL-OUTLINE PACKAGE

14-PINS SHOWN



- NOTES:
- A. All linear dimensions are in millimeters.
  - B. This drawing is subject to change without notice.
  - C. Body dimensions do not include mold flash or protrusion, not to exceed 0,15.



## IMPORTANT NOTICE

Texas Instruments Incorporated and its subsidiaries (TI) reserve the right to make corrections, enhancements, improvements and other changes to its semiconductor products and services per JESD46, latest issue, and to discontinue any product or service per JESD48, latest issue. Buyers should obtain the latest relevant information before placing orders and should verify that such information is current and complete. All semiconductor products (also referred to herein as "components") are sold subject to TI's terms and conditions of sale supplied at the time of order acknowledgment.

TI warrants performance of its components to the specifications applicable at the time of sale, in accordance with the warranty in TI's terms and conditions of sale of semiconductor products. Testing and other quality control techniques are used to the extent TI deems necessary to support this warranty. Except where mandated by applicable law, testing of all parameters of each component is not necessarily performed.

TI assumes no liability for applications assistance or the design of Buyers' products. Buyers are responsible for their products and applications using TI components. To minimize the risks associated with Buyers' products and applications, Buyers should provide adequate design and operating safeguards.

TI does not warrant or represent that any license, either express or implied, is granted under any patent right, copyright, mask work right, or other intellectual property right relating to any combination, machine, or process in which TI components or services are used. Information published by TI regarding third-party products or services does not constitute a license to use such products or services or a warranty or endorsement thereof. Use of such information may require a license from a third party under the patents or other intellectual property of the third party, or a license from TI under the patents or other intellectual property of TI.

Reproduction of significant portions of TI information in TI data books or data sheets is permissible only if reproduction is without alteration and is accompanied by all associated warranties, conditions, limitations, and notices. TI is not responsible or liable for such altered documentation. Information of third parties may be subject to additional restrictions.

Resale of TI components or services with statements different from or beyond the parameters stated by TI for that component or service voids all express and any implied warranties for the associated TI component or service and is an unfair and deceptive business practice. TI is not responsible or liable for any such statements.

Buyer acknowledges and agrees that it is solely responsible for compliance with all legal, regulatory and safety-related requirements concerning its products, and any use of TI components in its applications, notwithstanding any applications-related information or support that may be provided by TI. Buyer represents and agrees that it has all the necessary expertise to create and implement safeguards which anticipate dangerous consequences of failures, monitor failures and their consequences, lessen the likelihood of failures that might cause harm and take appropriate remedial actions. Buyer will fully indemnify TI and its representatives against any damages arising out of the use of any TI components in safety-critical applications.

In some cases, TI components may be promoted specifically to facilitate safety-related applications. With such components, TI's goal is to help enable customers to design and create their own end-product solutions that meet applicable functional safety standards and requirements. Nonetheless, such components are subject to these terms.

No TI components are authorized for use in FDA Class III (or similar life-critical medical equipment) unless authorized officers of the parties have executed a special agreement specifically governing such use.

Only those TI components which TI has specifically designated as military grade or "enhanced plastic" are designed and intended for use in military/aerospace applications or environments. Buyer acknowledges and agrees that any military or aerospace use of TI components which have **not** been so designated is solely at the Buyer's risk, and that Buyer is solely responsible for compliance with all legal and regulatory requirements in connection with such use.

TI has specifically designated certain components as meeting ISO/TS16949 requirements, mainly for automotive use. In any case of use of non-designated products, TI will not be responsible for any failure to meet ISO/TS16949.

### Products

Audio	<a href="http://www.ti.com/audio">www.ti.com/audio</a>
Amplifiers	<a href="http://amplifier.ti.com">amplifier.ti.com</a>
Data Converters	<a href="http://dataconverter.ti.com">dataconverter.ti.com</a>
DLP® Products	<a href="http://www.dlp.com">www.dlp.com</a>
DSP	<a href="http://dsp.ti.com">dsp.ti.com</a>
Clocks and Timers	<a href="http://www.ti.com/clocks">www.ti.com/clocks</a>
Interface	<a href="http://interface.ti.com">interface.ti.com</a>
Logic	<a href="http://logic.ti.com">logic.ti.com</a>
Power Mgmt	<a href="http://power.ti.com">power.ti.com</a>
Microcontrollers	<a href="http://microcontroller.ti.com">microcontroller.ti.com</a>
RFID	<a href="http://www.ti-rfid.com">www.ti-rfid.com</a>
OMAP Applications Processors	<a href="http://www.ti.com/omap">www.ti.com/omap</a>
Wireless Connectivity	<a href="http://www.ti.com/wirelessconnectivity">www.ti.com/wirelessconnectivity</a>

### Applications

Automotive and Transportation	<a href="http://www.ti.com/automotive">www.ti.com/automotive</a>
Communications and Telecom	<a href="http://www.ti.com/communications">www.ti.com/communications</a>
Computers and Peripherals	<a href="http://www.ti.com/computers">www.ti.com/computers</a>
Consumer Electronics	<a href="http://www.ti.com/consumer-apps">www.ti.com/consumer-apps</a>
Energy and Lighting	<a href="http://www.ti.com/energy">www.ti.com/energy</a>
Industrial	<a href="http://www.ti.com/industrial">www.ti.com/industrial</a>
Medical	<a href="http://www.ti.com/medical">www.ti.com/medical</a>
Security	<a href="http://www.ti.com/security">www.ti.com/security</a>
Space, Avionics and Defense	<a href="http://www.ti.com/space-avionics-defense">www.ti.com/space-avionics-defense</a>
Video and Imaging	<a href="http://www.ti.com/video">www.ti.com/video</a>

### TI E2E Community

[e2e.ti.com](http://e2e.ti.com)