



Part no.: 50142124
L250-P41SL-M12B8-PB-UCA
Safety locking device



Figure can vary

Contents

- Technical data
- Dimensioned drawings
- Electrical connection
- Accessories

Technical data

Basic data	
Series	L250
Functions	
Functions	Locking device with guard interlocking in acc. with EN ISO 14119 (type 4)
Activation mode of safety outputs	Safety outputs active if safety door is closed and locked
Operating principle	Quiescent current principle – Actuator locked if electromagnet is deactivated
Characteristic parameters	
SIL	3 , IEC 61508
SILCL	3 , IEC/EN 62061
Performance Level (PL)	Up to and including e , EN ISO 13849-1
MTTF _d	1,671 years , EN ISO 13849-1
PFH _D	1,24E-09 per hour
Mission time T _M	20 years , EN ISO 13849-1
Category	4 , EN ISO 13849 ,
DC	High
Encoding level	High , EN ISO 14119
Electrical data	
Protective circuit	
Type of wiring	Single connection
External safeguarding for supply circuit	2A type Gg (or equivalent)
Performance data	
Supply voltage U _B	24 V , DC , -10 ... 10 % ,
Current consumption, max.	1,200 mA
Inputs	
Number of digital switching inputs	3 Piece(s)
Switching inputs	
Type	Digital switching input
Switching voltage, typ.	24 V
Voltage type	DC
Current consumption, typ.	5 mA
Digital switching input 1	
Function	IE1 activation input: electromagnet
Digital switching input 2	
Function	IE2 activation input: electromagnet
Digital switching input 3	
Function	I3 programming input / control input for reset

Outputs

Number of safety-related switching outputs (OSSDs) 2 Piece(s)

Number of digital switching outputs 1 Piece(s)

Safety-related switching outputs

Type Safety-related switching output OSSD

Voltage type DC

Safety-related switching output 1

Switching element Transistor , PNP

Safety-related switching output 2

Switching element Transistor , PNP

Switching outputs

Type Digital switching output

Switching voltage, typ. 24 V

Voltage type DC

Switching output 1

Switching element Transistor , PNP

Function O3 signal output: protective-device closed

Connection

Number of connections 1 Piece(s)

Connection 1

Type of connection Connector

 Function Connection with PLC
Contact connection
Voltage supply

Thread size M12

Type Male

Material Metal

No. of pins 8 -pin

Encoding A-coded

Mechanical data

Housing material Plastic ,

Housing color Gray

Type of fastening Through-hole mounting

Side of cable entry From below

 Release device Auxiliary release
Escape release button

Approach speed 0.001 ... 0.5 m/s

Locking force, max. 2,100 N

Mechanical life time 1,000,000 actuation cycles , IEC 60947-5-1 switching cycles

Actuation frequency, max. 600 per hour , IEC 60947-5-1

Extraction force, unlocked actuator 20 N

RFID sensor data

 Assured operating distance S_{ao} 2 mm

 Assured cut-out distance S_{ar} 10 mm (actuator locked)
6 mm (actuator not locked)

 Nominal switching distance S_n 3 mm

 Repeatability $\leq 10\% S_n$

 Differential travel $\leq 20\% S_n$

Part no.: 50142124 – L250-P41SL-M12B8-PB-UCA – Safety locking device

Max. switching frequency	1 Hz
--------------------------	------

Operation and display

Type of display	LED
Number of LEDs	5 Piece(s)

Environmental data

Ambient temperature, operation	-20 ... 50 °C
Ambient temperature, storage	-40 ... 75 °C

Certifications

Degree of protection	IP 67 IP 69K
Certifications	c UL US ECOLAB TÜV Süd

Classification

eCl@ss 8.0	27272603
eCl@ss 9.0	27272603
ETIM 5.0	EC002593
ETIM 6.0	EC002593

Dimensioned drawings

All dimensions in millimeters

Safety locking device

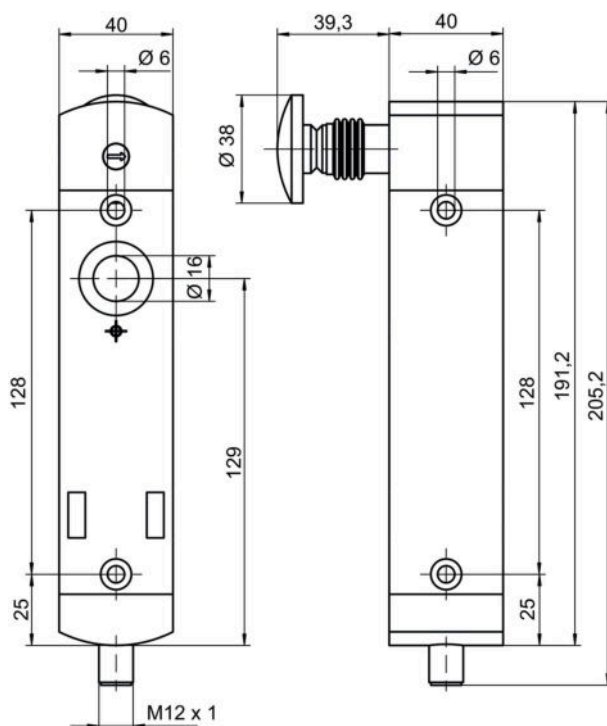

Actuator

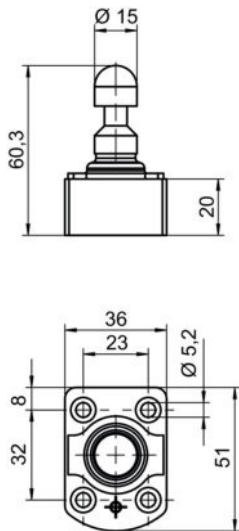

Electrical connection





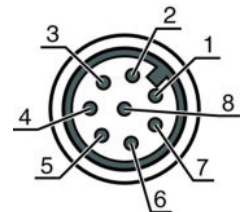



Connection 1	
Type of connection	Connector
Function	Connection with PLC Contact connection Voltage supply
Thread size	M12
Type	Male
Material	Metal
No. of pins	8 -pin
Encoding	A-coded

Pin	Pin assignment	Conductor color
1	A1 +24 V	White
2	O3 signal output: protective-device closed	Brown
3	A2 +0 V	Green
4	OS1 safe output	Yellow
5	IE2 activation input: electromagnet	Gray
6	I3 programming input / control input for reset	Pink
7	OS2 safe output	Blue
8	IE1 activation input: electromagnet	Red



Accessories

Connection technology - Connection cables

	Part no.	Designation	Article	Description
 	50135128	KD S-M12-8A-P1-050	Connection cable	Connection 1: Connector, M12, Axial, Female, A-coded, 8 -pin Connection 2: Open end Shielded: Yes Cable length: 5,000 mm Sheathing material: PUR
 	50135129	KD S-M12-8A-P1-100	Connection cable	Connection 1: Connector, M12, Axial, Female, A-coded, 8 -pin Connection 2: Open end Shielded: Yes Cable length: 10,000 mm Sheathing material: PUR
 	50135121	KD U-M12-8A-P1-020	Connection cable	Connection 1: Connector, M12, Axial, Female, A-coded, 8 -pin Connection 2: Open end Shielded: No Cable length: 2,000 mm Sheathing material: PUR
 	50135122	KD U-M12-8A-P1-050	Connection cable	Connection 1: Connector, M12, Axial, Female, A-coded, 8 -pin Connection 2: Open end Shielded: No Cable length: 5,000 mm Sheathing material: PUR

Actuator

	Part no.	Designation	Article	Description
	50142133 **	AC-L250-UCA	Actuator	Code type: Unique code Encoding level: High, EN ISO 14119 Dimensions: 40 mm x 48.1 mm x 59.4 mm Housing material: Plastic Housing color: Black Type of fastening: Through-hole mounting

** Included in delivery contents

Note

A list with all available accessories can be found on the Leuze electronic website in the Download tab of the article detailed page.