

MST 1-PHASE CONTROL AND ISOLATION TRANSFORMER

P: 400VA IN: 230/400VAC OUT: 230VAC

Single-phase - Control and Isolation Transformers
 400 VA
 Isolation class T 40/B
 Spring clamp terminals

Other voltages on request.

[Link to Product](#)

Illustration

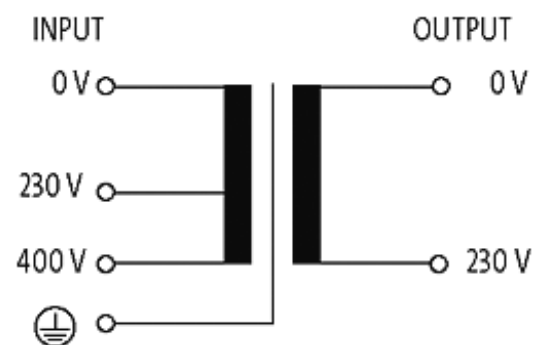

stay connected

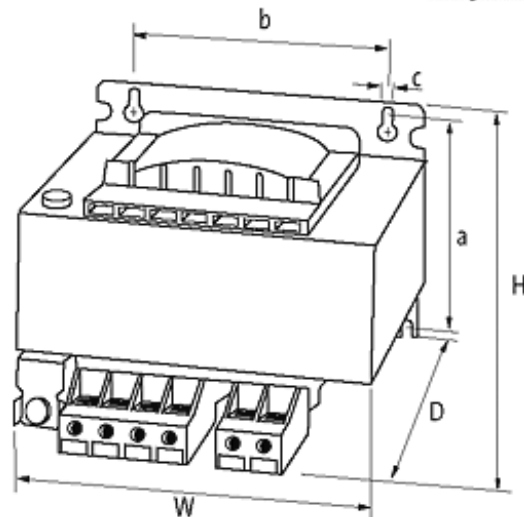

Product may differ from Image

Approvals



Input

Input voltage	230/400 V AC
Frequency	50...60 Hz
Input current	1.95 A (230 V AC); 1.1 A (400 V AC)
Inrush current	52.3 A (230 V AC); 30.2 A (400 V AC)
Short-circuit current	43 A (230 V AC); 24.9 A (400 V AC)

General data

Standards	(EN 61558-1), (EN 61558-2-4), (EN 62041 category 0)
Test isolation voltage	4 kV (prim./sec.)
Mounting method	Key-hole mounting
Temperature range	-20...+40 °C, no condensation
Dimensions H × W × D	104.2×120×122.4 mm
Fixing centers a × b × c	86.5×90×5.8 mm
Drill hole Ø	5.8×10 mm

Output

Output voltage	230 V AC
----------------	----------

Commercial data

country of origin	CZ
customs tariff number	85043180
minimum order quantity	1