

## M12 FEMALE 0° SHIELDED

PVC 5X0.34 shielded GRAY, 10m

M12

Female straight  
5-pole, shielded

Plastic housings with good resistance against chemicals and oils. The resistance to aggressive media should be individually tested for your application. Further details on request. Further cable lengths on request.

### [Link to Product](#)

#### Illustration

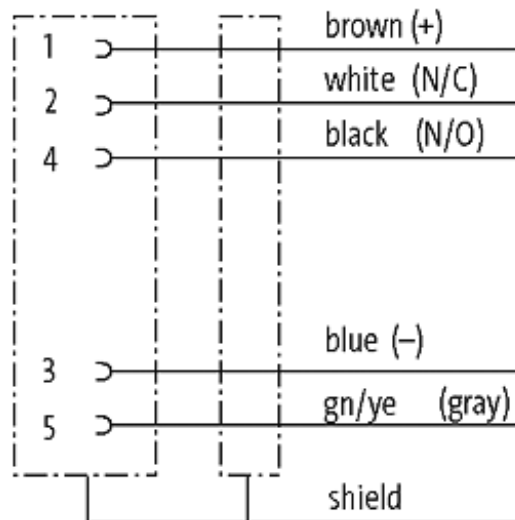
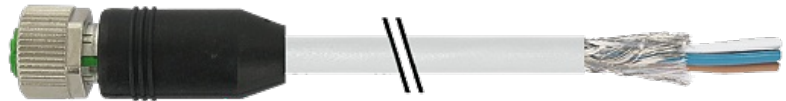

# Female



Product may differ from Image

## Approvals



## Form

13221

## Technical Data

Operating voltage	max. 60 V AC/DC
Operating current per contact	max. 4 A
Locking of ports	Screw thread M12 × 1 mm (recommended torque 0.6 Nm) self-securing
Protection	IP67 inserted and tightened (EN 60529)

## Cables

Cable number	347
No./diameter of wires	5 × 0.34 mm <sup>2</sup>
Wire isolation	PVC (br, wh, bl, bk, gr)
Jacket Color	gray
Shore hardness outer jacket	80 ± 5A
Material (jacket)	PVC
Outer diameter	approx. 5.9 mm

The information in this brochure has been compiled with the utmost care.

Liability for the correctness completeness and topicality of the information is restricted to gross negligence. Version: 05/15

Bend radius (fixed)	10 × outer Ø
Bend radius (moving)	15 × outer Ø
Temperature range (fixed)	-40...+80 °C
Temperature range (mobile)	-5...+80 °C
Shielded	yes

**Commercial data**

country of origin	DE
customs tariff number	85444290
minimum order quantity	1