

CIRCUIT	PART NO.	DIM A	COLOR
2	171692-0202	8.35	BLACK
4	171692-0204	12.05	
6	171692-0206	17.75	
8	171692-0208	23.45	
10	171692-0210	29.15	
12	171692-0212	34.85	

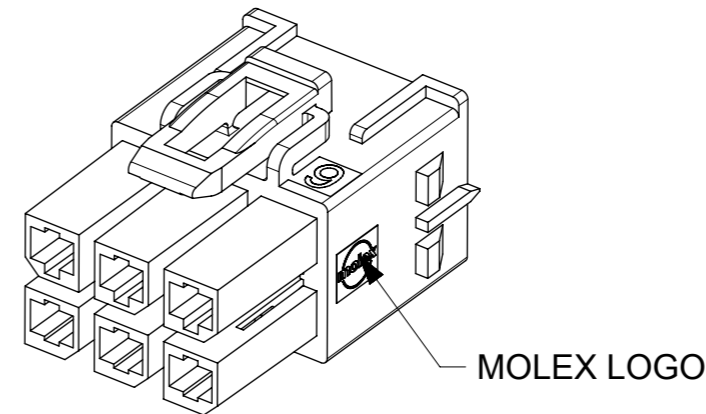
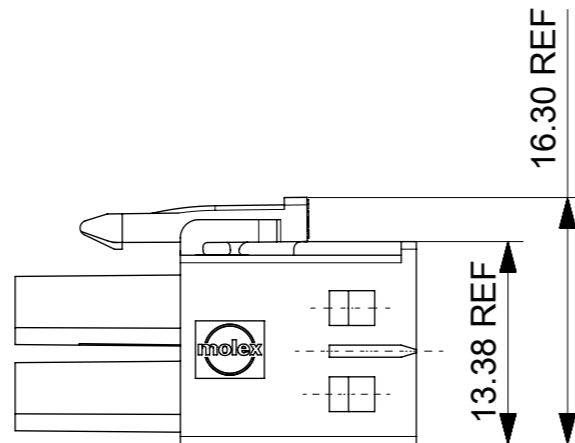
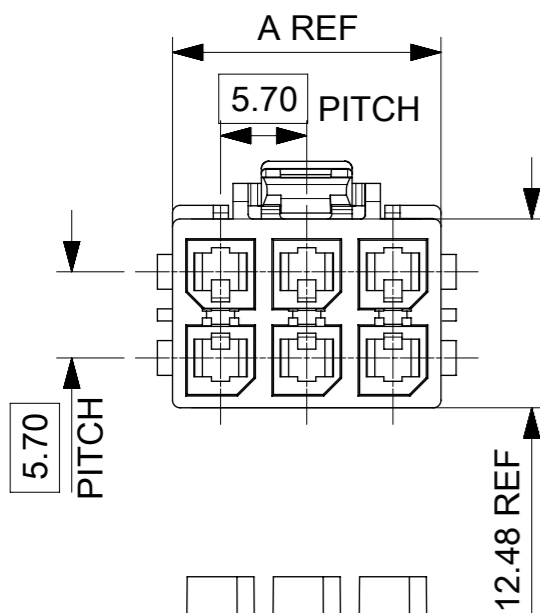

NOTES:

- MATERIAL :**
 NYLON, UL 94V-0 AND GLOW WIRE CAPABLE PER IEC60335-1.
 COLOR BLACK .
- PART USED WITH MOLEX SERIES.**
 HEADER:76829,172065;76825,172064
 PLUG: 105411
 TPA-CAPABLE FEMALE TERMINAL:76823,172063
 TPA:105415
- PRODUCT SPECIFICATION:**1054171000-PS/1720631000-PS
- PAKAGING SPECIFICATION:**1716920200
- APPLICATION SPECIFICATION:**768232000-AS

PENDING APPROVAL

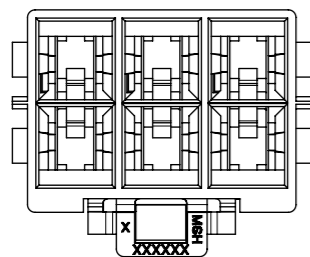
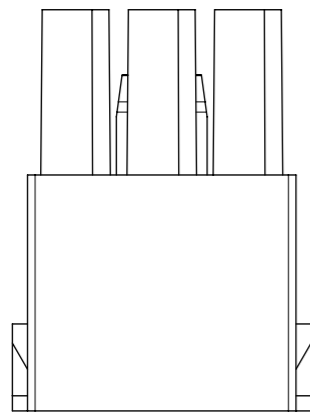

THIS DRAWING CONTAINS INFORMATION THAT IS PROPRIETARY TO MOLEX ELECTRONIC TECHNOLOGIES, LLC AND SHOULD NOT BE USED WITHOUT WRITTEN PERMISSION		CURRENT REV DESC:		molex		
DIMENSION UNITS	SCALE	EC NO: 628261				
mm		DRWN: ALUO02 2019/11/14		MEGA-FIT RECEPTACLE DR TPA		
GENERAL TOLERANCES (UNLESS SPECIFIED)		CHK'D:		PRODUCT CUSTOMER DRAWING		
ANGULAR TOL	± 0.5 °	APPR:		DOCUMENT NUMBER		
4 PLACES	±	INITIAL REVISION:		1716920200		
3 PLACES	±	DRWN: YXZHENG 2016/12/15		DOC TYPE	DOC PART	
2 PLACES	± 0.25	APPR: YXZHENG 2018/08/06		PSD	000	
1 PLACE	± 0.35			REVISION		
0 PLACES	±			D1		
DRAFT WHERE APPLICABLE MUST REMAIN WITHIN DIMENSIONS		THIRD ANGLE PROJECTION	DRAWING	SERIES	MATERIAL NUMBER	CUSTOMER
			A3-SIZE	171692	SEE CHART	GENERAL MARKET
				SHEET NUMBER		1 OF 2

DOCUMENT STATUS	RQ	RELEASE DATE
-----------------	----	--------------

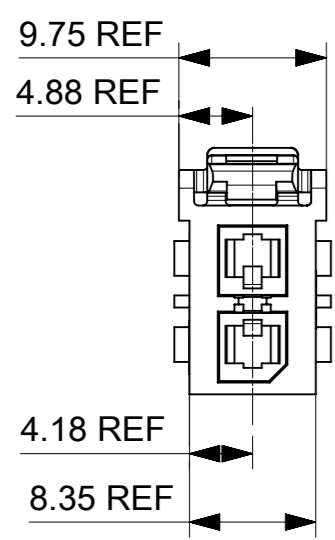

2 CKT

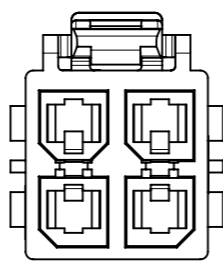
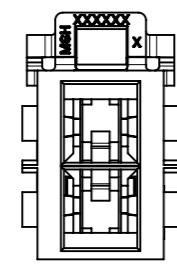

4 CKT

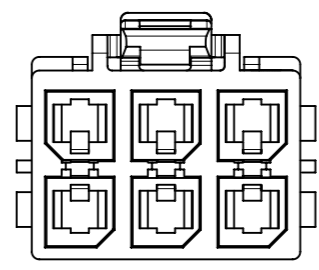
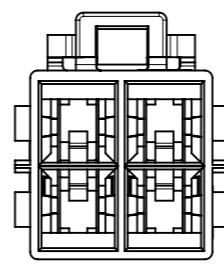

6 CKT

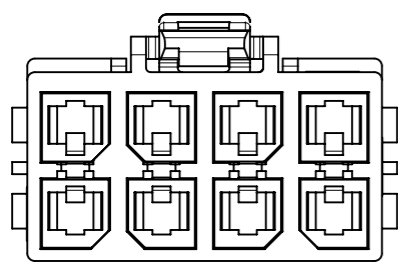
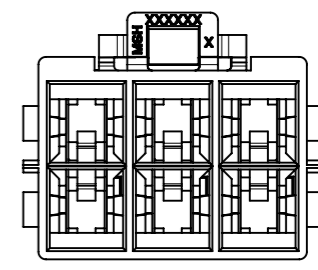

8 CKT

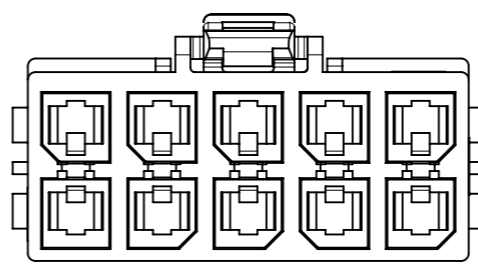
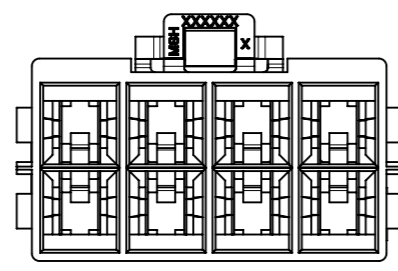

10 CKT

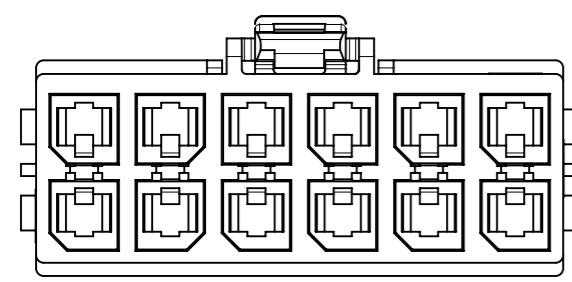
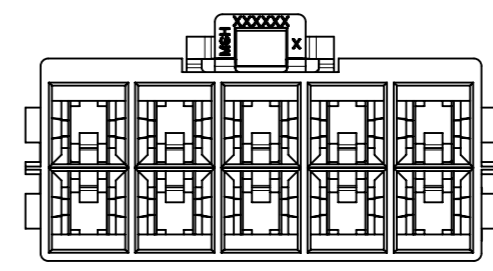

12 CKT

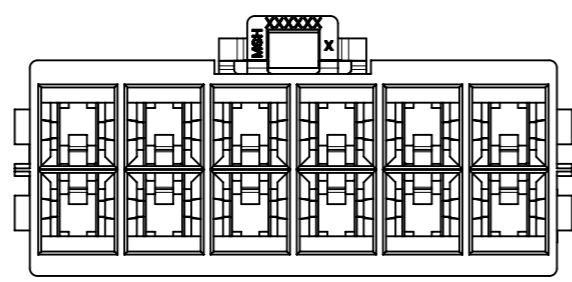

PENDING APPROVAL

THIS DRAWING CONTAINS INFORMATION THAT IS PROPRIETARY TO MOLEX ELECTRONIC TECHNOLOGIES, LLC AND SHOULD NOT BE USED WITHOUT WRITTEN PERMISSION		CURRENT REV DESC:		molex	
DIMENSION UNITS	SCALE	EC NO: 628261			
mm		DRWN: ALUO02		2019/11/14	PRODUCT CUSTOMER DRAWING
GENERAL TOLERANCES (UNLESS SPECIFIED)		CHK'D:		DOCUMENT NUMBER	
ANGULAR TOL	± 0.5°	APPR:		1716920200	DOC TYPE DOC PART REVISION
4 PLACES	±	INITIAL REVISION:		PSD	000 D1
3 PLACES	±	DRWN: YXZHENG		MATERIAL NUMBER	
2 PLACES	± 0.25	APPR: YXZHENG		SEE CHART	CUSTOMER
1 PLACE	± 0.35	SERIES		GENERAL MARKET	SHEET NUMBER
0 PLACES	±	A3-SIZE		171692	2 OF 2
DRAFT WHERE APPLICABLE MUST REMAIN WITHIN DIMENSIONS		THIRD ANGLE PROJECTION	DRAWING	CUSTOMER	
			A3-SIZE	GENERAL MARKET	