

## MLN 150/1 schwarz/black

Industrial Connectors:Measuring and Testing Equipment:Measuring leads:4 mm system

### Product description

Description	Measuring lead, at either end 4 mm diameter plug with caged spring and 4 mm diameter socket for tower construction. Nickel-plated copper beryllium contact spring. Highly flexible, double insulated stranded lead, grip and lead shatter-proof. Built in colour indicator for easy identification of insulation damages.
Type	MLN 150/1 schwarz/black
Order No.	934 064-100
System	4 mm system
Cable length	150 cm
Conductor size	1 mm <sup>2</sup>
Cable material	PVC
Cable color	black
Housing Color	black
Color types	●●●●●
Other standard types	red color, order no. 934 064-101; blue color, order no. 934 064-102; yellow color, order no. 934 064-103; green color, order no. 934 064-104

### Drawing

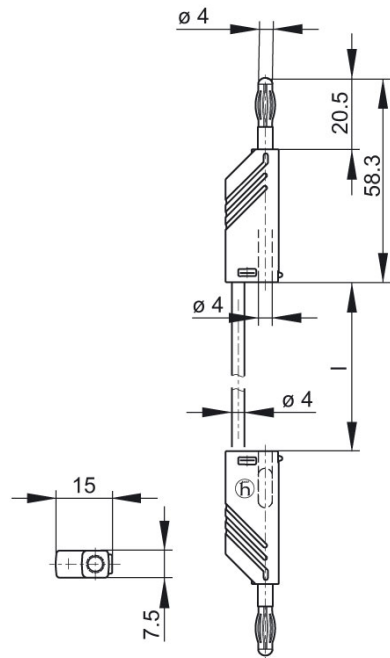

#### Technical data

Pin dimensions	4 mm
Type of contact	pin (spring-loaded)
Type of termination	4 mm diameter pin and socket
Cable type	LEH-XY
Cable specification	highly flexible lead
Wire stranding	259 x 0,07
Rated voltage	DC 60 V
Rated current	16 A
Contact resistance	34 mOhm

#### Material

Contact material	contact pin: brass, contact spring: copper beryllium
Contact surface material	nickel-plated
Housing material	PA

#### Environmental conditions

Temperature range	-15 °C to +70 °C
-------------------	------------------

#### Inflammability class

Cable	94 HB
Housing	94 V-2