

M12 male 0° / M8 male 0°, shielded, Ethercat

PUR 1x4xAWG26 shielded gn UL/CSA+drag chain 7m

EtherCAT

Male straight to male straight

M12 - M8

4-pole, shielded

Further cable lengths on request. Plastic housings with good resistance against chemicals and oils. The resistance to aggressive media should be individually tested for your application. Further details on request.

[Link to Product](#)

Illustration

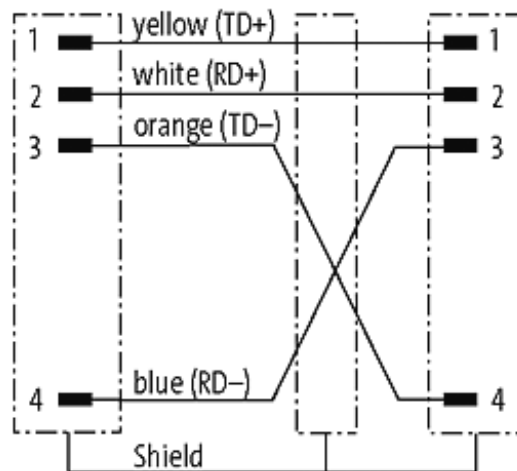

Male

Male

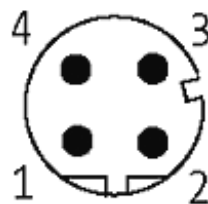

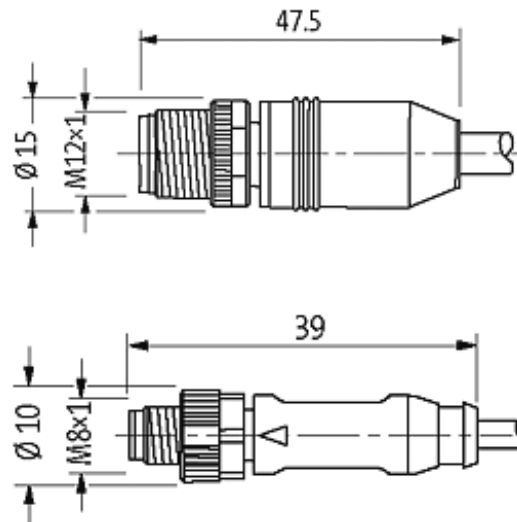

Product may differ from Image

Approvals



Form

44901

Technical Data

Operating voltage	30 V AC/DC
Operating current per contact	max. 4 A
Locking of ports	Screw thread M8 × 1 mm (recommended torque 0.4 Nm) self-securing
Protection	IP67 inserted and tightened (EN 60529)

Cables

Cable number	791
No./diameter of wires	1 × 4 × AWG26
Wire isolation	PE (wh, ye, bl, or)
C-track properties	5 Mio.
Jacket Color	green
Shore hardness outer jacket	85 ± 5A
Material (jacket)	PUR (UL/CSA)
Outer diameter	approx. 4.9 mm
Bend radius (fixed)	7.5 × outer Ø
Bend radius (moving)	12 × outer Ø
Temperature range (fixed)	-20...+80 °C
Temperature range (mobile)	-20...+50 °C
Shielded	yes

Commercial data

The information in this brochure has been compiled with the utmost care.

Liability for the correctness completeness and topicality of the information is restricted to gross negligence. Version: 05/15

country of origin	DE
customs tariff number	85444290
minimum order quantity	1
