

Stainl. steel actuator IP69 (K), w. transverse mounting for extreme ambient conditions such as minus 40 degrees w. incr. corrosion protection for safety position switch with tumbler 3SE5312/3SE5322 and AS-i, 3SF13 and safety position switch with separate actuator without tumbler 3SE51/3SE52 and AS-i, 3SF11/12



Figure similar

Product designation	actuator
General technical data	
Shock resistance	
• acc. to IEC 60068-2-27	30 g / 11 ms
Vibration resistance	
• acc. to IEC 60068-2-6	0.35 mm/5g
Mechanical service life (switching cycles)	
• typical	1 000 000
Equipment marking	
• acc. to DIN EN 61346-2	T
• acc. to DIN EN 81346-2	T
Active principle	mechanical
Drive Head	
Design of the operating mechanism	Actuator with transverse attachment, stainless steel
Ambient conditions	
Ambient temperature	

- during operation
- during storage

-40 ... +85 °C

-40 ... +90 °C

Installation/ mounting/ dimensions

Mounting position

any

Mounting type

screw fixing

Certificates/approvals

General Product Approval

**Declaration of
Conformity**

other



CSA



UR



EG-Konf.

[Confirmation](#)

Further information

Information- and Downloadcenter (Catalogs, Brochures,...)

<http://www.siemens.com/industrial-controls/catalogs>

Industry Mall (Online ordering system)

<https://mall.industry.siemens.com/mall/en/en/Catalog/product?mlfb=3SE5000-0AW53>

Cax online generator

<http://support.automation.siemens.com/WW/CAXorder/default.aspx?lang=en&mlfb=3SE5000-0AW53>

Service&Support (Manuals, Certificates, Characteristics, FAQs,...)

<https://support.industry.siemens.com/cs/ww/en/ps/3SE5000-0AW53>

Image database (product images, 2D dimension drawings, 3D models, device circuit diagrams, EPLAN macros, ...)

http://www.automation.siemens.com/bilddb/cax_de.aspx?mlfb=3SE5000-0AW53&lang=en

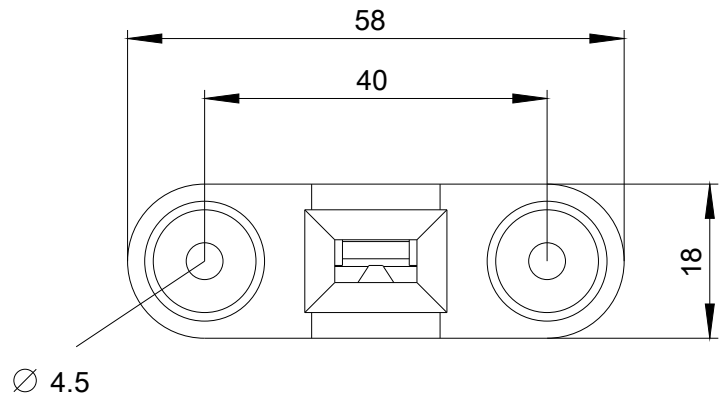
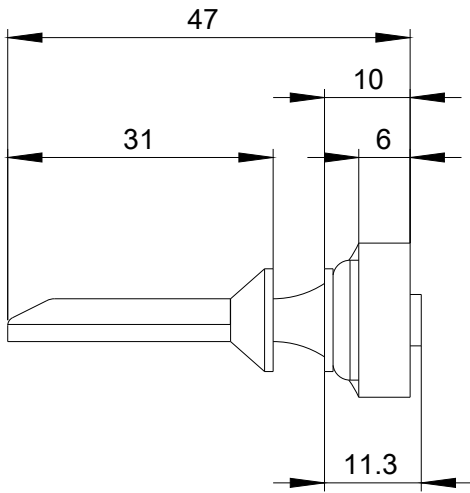

last modified:

09/25/2017